

# Technical Noise Supplement to the Traffic Noise Analysis Protocol

September 2013



California Department of Transportation  
Division of Environmental Analysis  
Environmental Engineering  
Hazardous Waste, Air, Noise, Paleontology Office

*This page intentionally left blank*

CALTRANS Technical Report Documentation Page

1. Report No. CT-HWANP-RT-13-069.25.2	2. Type of Report Reference & Guidance	3. Report Phase and Edition Final	
4. Title and Subtitle Technical Noise Supplement to the Caltrans Traffic Noise Analysis Protocol A Guide for the Measuring, Modeling, and Abating Highway Operation and Construction Noise Impacts		5. Report Date September 2013	
6. Author(s) Rudy Hendriks, Bruce Rymer, David Buehler, Jim Andrews		7. Caltrans Project Coordinator Bruce Rymer, PE Senior Engineer	
8. Performing Organization Names and Addresses California Department of Transportation Division of Environmental Analysis Environmental Engineering Hazardous Waste, Air, Noise, & Paleontology Office 1120 N Street, Mail Stop 27 Sacramento CA 95814 <a href="http://www.dot.ca.gov/hq/env/noise/index.htm">http://www.dot.ca.gov/hq/env/noise/index.htm</a>		9. Task Order No. 25	
		10. Contract No. : 43A0269 – ICF International	
11. Sponsoring Agency Name and Address California Department of Transportation Division of Environmental Analysis Environmental Engineering Hazardous Waste, Air, Noise, & Paleontology Office Sacramento CA 95814		12. Caltrans Functional Reviewers:  <i>Division of Environmental Analysis:</i> Bruce Rymer & Jim Andrews	
13. Supplementary Notes This document updates and supersedes the Nov 2009 <i>Technical Noise Supplement</i> . Refer to the Sept 2013 <i>Caltrans Highway Traffic Noise Analysis Protocol</i> for noise-related policy.		14. External Reviewers	
15. Abstract This manual contains Caltrans noise analysis procedures, practices, and other useful technical background information related to the analysis and reporting of highway and construction noise impacts and abatement. It supplements and expands on concepts and procedures referred to in the <i>Traffic Noise Analysis Protocol</i> , which in turn is required by federal regulations in 23CFR772. <i>The contents of this document are not official policy, standard, or regulation</i> , and are for informational purposes— <i>unless they are referenced in the Protocol</i> . Except for some Caltrans-specific methods and procedures, most methods and procedures recommended in this document are in conformance with industry standards and practices. This document can be used as a stand-alone guide for highway noise training purposes or as a reference for technical concepts, methodology, and terminology needed to acquire a basic understanding of highway noise and construction noise-related issues.			
16. Key Words Highway noise, highway noise measurement, noise barrier design, traffic noise impact analysis, noise study reports, construction noise.	17. Distribution Statement Available to the general public		18. No. of pages 276

*This page intentionally left blank*

# **Technical Noise Supplement to the Caltrans Traffic Noise Analysis Protocol**

*A Guide for Measuring, Modeling, and Abating Highway  
Operation and Construction Noise Impacts*

California Department of Transportation  
Division of Environmental Analysis  
Environmental Engineering  
Hazardous Waste, Air, Noise, Paleontology Office  
1120 N Street, Room 4301 MS27  
Sacramento, CA 95814  
Contact: Bruce Rymer  
916/653-6073

September 2013

© 2013 California Department of Transportation



# Contents

	Page
Tables .....	vi
Figures .....	viii
Acronyms and Abbreviations .....	xii
Acknowledgements .....	xiv
<b>Section 1 Introduction and Overview .....</b>	<b>1-1</b>
1.1 Introduction .....	1-1
1.2 Overview .....	1-2
<b>Section 2 Basics of Highway Noise .....</b>	<b>2-1</b>
2.1 Physics of Sound .....	2-1
2.1.1 Sound, Noise, and Acoustics .....	2-1
2.1.2 Speed of Sound .....	2-2
2.1.3 Sound Characteristics .....	2-3
2.1.3.1 Frequency, Wavelength, and Hertz .....	2-3
2.1.3.2 Sound Pressure Levels and Decibels .....	2-7
2.1.3.3 Root Mean Square and Relative Energy .....	2-8
2.1.3.4 Relationship between Sound Pressure Level, Relative Energy, Relative Pressure, and Pressure .....	2-9
2.1.3.5 Adding, Subtracting, and Averaging Sound Pressure Levels .....	2-11
2.1.3.6 A-Weighting and Noise Levels .....	2-18
2.1.3.7 Octave and One-Third-Octave Bands and Frequency Spectra .....	2-21
2.1.3.8 White and Pink Noise .....	2-27
2.1.4 Sound Propagation .....	2-27
2.1.4.1 Geometric Spreading from Point and Line Sources .....	2-27
2.1.4.2 Ground Absorption .....	2-30
2.1.4.3 Atmospheric Effects and Refraction .....	2-31
2.1.4.4 Shielding by Natural and Manmade Features, Noise Barriers, Diffraction, and Reflection .....	2-35
2.2 Effects of Noise and Noise Descriptors .....	2-43
2.2.1 Human Reaction to Sound .....	2-43
2.2.1.1 Human Response to Changes in Noise Levels .....	2-44
2.2.2 Describing Noise .....	2-46

	2.2.2.1	Time Patterns .....	2-46
	2.2.2.2	Noise Descriptors .....	2-47
	2.2.2.3	Calculating Noise Descriptors.....	2-48
	2.2.3	Conversion between Noise Descriptors.....	2-55
	2.2.4	Negative Effects on Humans.....	2-59
	2.2.4.1	Hearing Damage .....	2-60
	2.2.4.2	Interference with Activities .....	2-60
	2.2.4.3	Stress-Related Diseases .....	2-61
<b>Section 3</b>		<b>Measurements and Instrumentation .....</b>	<b>3-1</b>
	3.1	Purposes of Noise Measurements .....	3-1
	3.1.1	Ambient and Background Noise Levels.....	3-2
	3.1.2	Model Validation/Calibration.....	3-3
	3.1.3	Construction Noise Levels.....	3-3
	3.1.4	Performance of Abatement Measures .....	3-3
	3.1.5	Special Studies and Research .....	3-3
	3.2	Measurement Locations.....	3-4
	3.2.1	General Site Recommendations.....	3-4
	3.2.2	Measurement Site Selection .....	3-4
	3.2.2.1	Site Selection by Purpose of Measurement .....	3-5
	3.2.2.2	Site Selection by Acoustical Equivalence.....	3-6
	3.2.2.3	Site Selection by Geometry .....	3-8
	3.3	Measuring Times, Duration, and Number of Repetitions.....	3-9
	3.3.1	Measuring Times .....	3-9
	3.3.1.1	Noisiest Hour for Highway Traffic .....	3-10
	3.3.1.2	Adjusting Other-Than-Noisiest Hour .....	3-11
	3.3.2	Measurement Duration.....	3-12
	3.3.3	Number of Measurement Repetitions.....	3-13
	3.3.4	Normalizing Measurements for Differences in Traffic Mixes and Volumes .....	3-18
	3.3.5	Classroom Noise Measurements .....	3-22
	3.4	Instrumentation .....	3-25
	3.4.1	Sound Level Meters .....	3-25
	3.4.2	Data Recording and Analysis .....	3-27
	3.4.3	Acoustical Calibrators .....	3-28
	3.4.4	Meteorological and Other Non-Noise-Related Equipment.....	3-28
	3.5	Noise Measurement Procedures.....	3-29
	3.5.1	Instrumentation Setup.....	3-29
	3.5.2	Field Calibration .....	3-30
	3.5.3	Measurements .....	3-31
	3.5.4	Documentation.....	3-32
	3.6	Meteorological Constraints on Noise Measurements .....	3-33
	3.6.1	Meteorological Criteria .....	3-34
	3.6.2	Equivalent Meteorological Conditions.....	3-34
	3.6.2.1	Equivalent Wind Conditions .....	3-35



	3.6.2.2	Equivalent Temperature and Cloud Cover.....	3-36
	3.6.2.3	Equivalent Humidity.....	3-36
	3.7	Quality Assurance.....	3-36
<b>Section 4</b>		<b>Detailed Analysis for Traffic Noise Impacts .....</b>	<b>4-1</b>
	4.1	Gathering Information.....	4-1
	4.2	Identifying Existing and Future Land Use and Applicable Noise Abatement Criteria.....	4-1
	4.3	Determining Existing Noise Levels.....	4-3
	4.3.1	Selecting Noise Receivers and Noise Measurement Sites.....	4-3
	4.3.1.1	Receptors and Receivers.....	4-3
	4.3.1.2	Noise Measurement Sites.....	4-6
	4.3.2	Measuring Existing Noise Levels.....	4-6
	4.3.3	Modeling Existing Noise Levels.....	4-7
	4.4	Validating/Calibrating the Prediction Model.....	4-7
	4.4.1	Routine Model Calibration.....	4-8
	4.4.1.1	Introduction.....	4-8
	4.4.1.2	Limitations.....	4-8
	4.4.1.3	Pertinent Site Conditions.....	4-9
	4.4.1.4	Procedures.....	4-10
	4.4.1.5	Cautions and Challenges.....	4-11
	4.4.1.6	Tolerances.....	4-13
	4.4.1.7	Common Dilemmas.....	4-13
	4.5	Predicting Future Noise Levels.....	4-14
	4.5.1	FHWA TNM Overview.....	4-15
	4.5.1.1	TNM Reference Energy Mean Emission Levels.....	4-15
	4.5.1.2	Noise Level Computations.....	4-18
	4.5.1.3	Propagation, Shielding, and Ground Effects.....	4-19
	4.5.1.4	Parallel Barrier Analysis.....	4-19
	4.6	Comparing Results with Appropriate Criteria.....	4-20
	4.7	Evaluating Noise Abatement Options.....	4-20
<b>Section 5</b>		<b>Noise Barrier Design Considerations .....</b>	<b>5-1</b>
	5.1	Acoustical Design Considerations.....	5-1
	5.1.1	Barrier Material and Transmission Loss.....	5-3
	5.1.2	Barrier Location.....	5-6
	5.1.3	Barrier Dimensions.....	5-13
	5.1.3.1	Height.....	5-15
	5.1.3.2	Length.....	5-21
	5.1.4	Barrier Shape.....	5-23
	5.1.5	Barrier Insertion Loss vs. Attenuation.....	5-25
	5.1.6	Background Noise Levels.....	5-26
	5.1.7	Reflected Noise and Noise Barriers.....	5-27
	5.1.7.1	Noise Reflection.....	5-27
	5.1.7.2	Single Barriers.....	5-29
	5.1.7.3	Modeling Single Barrier Reflections.....	5-35
	5.1.7.4	Parallel Barriers.....	5-37

5.1.7.5	Reflections off Structures and Canyon Effects .....	5-41
5.1.7.6	Double-Deck Bridge Reflections .....	5-43
5.1.7.7	Minimizing Reflections .....	5-51
5.1.8	Miscellaneous Acoustical Design Considerations .....	5-52
5.1.8.1	Maintenance Access behind Noise Barriers.....	5-52
5.1.8.2	Emergency Access Gates in Noise Barriers.....	5-54
5.1.8.3	Drainage Openings in Noise Barriers.....	5-54
5.1.8.4	Vegetation as Noise Barriers .....	5-55
5.2	Non-Acoustical Considerations .....	5-55
5.2.1	Safety.....	5-55
5.2.2	Aesthetics .....	5-56
<b>Section 6</b>	<b>Noise Study Reports .....</b>	<b>6-1</b>
6.1	Outline .....	6-2
6.2	Summary .....	6-4
6.3	Noise Impact Technical Study.....	6-4
6.3.1	Introduction .....	6-4
6.3.2	Project Description.....	6-4
6.3.3	Fundamentals of Traffic Noise.....	6-5
6.3.4	Federal and State Standards and Policies .....	6-6
6.3.5	Study Methods and Procedures .....	6-6
6.3.6	Existing Noise Environment .....	6-7
6.3.7	Future Noise Environment, Impacts, and Considered Abatement.....	6-8
6.3.8	Construction Noise.....	6-10
6.3.9	References .....	6-10
6.4	Appendices .....	6-16
<b>Section 7</b>	<b>Non-Routine Considerations and Issues .....</b>	<b>7-1</b>
7.1	Noise Barrier Issues.....	7-1
7.1.1	Effects of Noise Barriers on Distant Receivers .....	7-2
7.1.1.1	Background .....	7-2
7.1.1.2	Results of Completed Studies.....	7-3
7.1.1.3	Studying the Effects of Noise Barriers on Distant Receivers .....	7-7
7.1.2	Shielding Provided by Vegetation.....	7-7
7.2	Sound Intensity and Power .....	7-8
7.2.1	Sound Power .....	7-9
7.2.2	Sound Intensity .....	7-10
7.3	Tire/Pavement Noise .....	7-13
7.4	Insulating Facilities from Highway Noise .....	7-16
7.5	Construction Noise Analysis, Monitoring, and Abatement .....	7-17
7.5.1	Consideration of Construction Noise during Project Development Phase.....	7-20
7.5.2	Noise Monitoring during Construction .....	7-23
7.5.3	Construction Noise Abatement.....	7-26

7.5.3.1	Abatement at Source .....	7-26
7.5.3.2	Abatement in Path .....	7-26
7.5.3.3	Abatement at Receiver .....	7-27
7.5.3.4	Community Awareness .....	7-27
7.6	Earthborne Vibration .....	7-27
7.7	Occupational Hearing Loss and OSHA Noise Standards .....	7-28
7.7.1	Noise-Induced Hearing Loss .....	7-29
7.7.2	OSHA Noise Standards .....	7-29
7.8	Effects of Transportation and Construction Noise on Marine Life and Wildlife (Bioacoustics) .....	7-31
<b>Section 8</b>	<b>Glossary .....</b>	<b>8-1</b>
<b>Appendix A</b>	<b>References Cited</b>	

# Tables

	Page
2-1 Wavelength of Various Frequencies .....	2-6
2-2 Relationship between Sound Pressure Level, Relative Energy, Relative Pressure, and Sound Pressure.....	2-10
2-3 Decibel Addition .....	2-14
2-4 A-Weighting Adjustments for One-Third-Octave Center Frequencies .....	2-19
2-5 Typical Noise Levels .....	2-20
2-6 Standardized Band Numbers, Center Frequencies, One-Third-Octave and Octave Bands, and Octave Band Ranges.....	2-22
2-7 Tabular Form of Octave Band Spectrum .....	2-24
2-8 Tabular Form of One-Third Octave Band Spectrum .....	2-25
2-9 Adjusting Linear Octave Band Spectrum to A-Weighted Spectrum.....	2-26
2-10 Relationship between Noise Level Change, Factor Change in Relative Energy, and Perceived Change .....	2-45
2-11 Common Noise Descriptors.....	2-48
2-12 Noise Samples for L10 Calculation.....	2-49
2-13 Noise Samples for Leq Calculation.....	2-51
2-14 Noise Samples for Ldn Calculations .....	2-52
2-15 Leq/Ldn Conversion Factors.....	2-58
2-16 Ldn/CNEL Corrections ( $\Delta$ ) (Must Be Added to Ldn to Obtain CNEL).....	2-59

3-1	Suggested Measurement Durations .....	3-12
3-2	Maximum Allowable Standard Deviations for a 95% Confidence Interval for Mean Measurement of about 1 dBA.....	3-17
3-3	Equivalent Vehicles Based on Federal Highway Administration Traffic Noise Model Reference Energy Mean Emission Levels.....	3-19
3-4	Classes of Wind Conditions.....	3-35
3-5	Cloud Cover Classes.....	3-36
4-1	Activity Categories and Noise Abatement Criteria (23 CFR 772).....	4-2
4-2	TNM Constants for Vehicle Types .....	4-17
5-1	Approximate Transmission Loss Values for Common Materials.....	5-4
5-2	Contribution of Reflections for Special Case Where $W = 2S$ , $D = W$ , and $NRC = 0.05$ .....	5-40
5-3	Summary of Reflective Noise Contributions and Cumulative Noise Levels .....	5-51
6-1	Noise Study Report Outline .....	6-2
6-2	Existing Noise Levels (Example) .....	6-11
6-3	Predicted Traffic Noise Impacts (Example).....	6-12
6-4	Noise Abatement Predicted Noise Levels and Insertion Loss (dBA) for Soundwall 1 at Right-of-Way (Example).....	6-13
6-5	Data for Reasonableness Determination (Example) .....	6-14
6-6	Roadway and Barrier Geometries (Example) .....	6-15
6-7	Model Calibration (Example) .....	6-16
7-1	FHWA Building Noise Reduction Factors .....	7-17
7-2	Typical Construction Equipment Noise .....	7-21
7-3	Table G-16 Permissible Noise Exposure .....	7-30

# Figures

	<b>Page</b>
2-1 Sound Pressure vs. Particle Velocity .....	2-4
2-2 Frequency and Wavelength.....	2-5
2-3 Peak and Root Mean Square Sound Pressure .....	2-9
2-4 A-Weighting Network.....	2-19
2-5 Typical Octave Band Frequency Spectrum.....	2-23
2-6 Typical One-Third-Octave Band Frequency Spectrum.....	2-25
2-7 Point Source Propagation (Spherical Spreading).....	2-28
2-8 Change in Noise Level with Distance from Spherical Spreading.....	2-29
2-9 Line Source Propagation (Cylindrical Spreading) .....	2-30
2-10 Wind Effects on Noise Levels .....	2-32
2-11 Effects of Temperature Gradients on Noise.....	2-34
2-12 Alteration of Sound Paths after Inserting a Noise Barrier between Source and Receiver.....	2-37
2-13 Diffraction of Sound Waves .....	2-39
2-14 Path Length Difference between Direct and Diffracted Noise Paths ....	2-40
2-15 Barrier Attenuation ( $\Delta B$ ) vs. Fresnel Number ( $N_0$ ) for Infinitely Long Barriers.....	2-41
2-16 Direct Noise Path Grazing Top of Barrier, Resulting in 5 dBA of Attenuation .....	2-42
2-17 Negative Diffraction, Which Provides Some Noise Attenuation.....	2-43
2-18 Different Noise Level vs. Time Patterns.....	2-46

2-19	Relationship between $L_{dn}$ and $L_{eq}(h)_{pk}$ .....	2-58
2-20	Interference of Conversation from Background Noise.....	2-61
3-1	Typical Measurement Site Locations .....	3-7
3-2	Typical Noise Measurement Site Locations .....	3-8
3-3	Receiver Partially Shielded by Top of Cut vs. Unshielded Receiver.....	3-9
3-4	Classroom Noise Measurements (Reconstruction of Existing Freeway) .....	3-23
3-5	Classroom Noise Measurements (Project on New Alignment with Artificial Sound Source).....	3-24
4-1	A-Weighted Baseline FHWA TNM REMEL Curves.....	4-18
5-1	Alteration of Noise Paths by a Noise Barrier.....	5-3
5-2	Barrier Diffraction .....	5-3
5-3	Path Length Difference.....	5-7
5-4	Barrier Attenuation as a Function of Location (At-Grade Highway)—Barrier Attenuation Is Least When Barrier Is Located Halfway Between the Source and Receiver <i>b</i> ; the Best Locations Are Near the Source <i>a</i> or Receiver <i>c</i> .....	5-8
5-5	Typical Barrier Location for Depressed Highways .....	5-9
5-6	Typical Barrier Location for Elevated Highways.....	5-10
5-7	Barriers for Cut and Fill Transitions .....	5-11
5-8	Barriers for Highway on Fill with Off-Ramp .....	5-12
5-9	Barriers for Highway in Cut with Off-Ramp .....	5-13
5-10	Actual Noise Barrier Height Depends on Site Geometry and Terrain Topography (Same Barrier Attenuation for <i>a</i> , <i>b</i> , <i>c</i> , and <i>d</i> ).....	5-14
5-11	Noise Barrier Length Depends on Size of the Area to Be Shielded and Site Geometry and Topography .....	5-14
5-12	Soundwall Attenuation vs. Height for At-Grade Freeway .....	5-15
5-13	Soundwall Attenuation vs. Height for 25-Foot Depressed Freeway .....	5-17

5-14	Loss of Soft-Site Characteristics from Constructing a Noise Barrier .....	5-18
5-15	Determination of Critical Lane for Line-of-Sight Height .....	5-20
5-16	Recommended Line-of-Sight Break Limits.....	5-20
5-17	Barrier Extended Far Enough to Protect End Receivers .....	5-21
5-18	4D Rule .....	5-22
5-19	Barrier Wrapped around End Receivers, an Effective Alternative .....	5-23
5-20	Thin Screen vs. Berm (Berm Gives More Barrier Attenuation).....	5-24
5-21	Various Wall Shapes (Minimal Benefit for Extra Cost) .....	5-24
5-22	Barrier Insertion Loss vs. Attenuation .....	5-25
5-23	Single-Barrier Reflection (Simplest Representation).....	5-29
5-24	Single-Barrier Reflections (Infinite Line Source and Noise Barrier).....	5-30
5-25	Single-Barrier Reflection (More Accurate Representation) .....	5-31
5-26	Noise Increases from Single-Barrier Reflections.....	5-32
5-27	Single-Barrier Reflection (Direct Noise Shielded, Reflected Noise Not Shielded) .....	5-33
5-28	Single-Barrier Reflection (Noise Barrier on Top of Opposite Cut) .....	5-34
5-29	Highway and Noise Barrier on Fill .....	5-34
5-30	Placement of Image Sources (Cross Sectional View) .....	5-35
5-31	Placement of Image Sources (Plan View).....	5-36
5-32	Various Reflective Noise Paths for Parallel Noise Barriers .....	5-39
5-33	W/H <sub>AVG</sub> Ratio Should be 10:1 or Greater .....	5-41
5-34	Noise Reflection off Structure .....	5-42
5-35	Double-Deck Structure Reflections, First Reflective Path .....	5-44
5-36	Multiple Reflective Paths .....	5-49
5-37	Barrier Offset with Solid Gate .....	5-53



5-38	Barrier Overlap Offset 2.5 to 3 Times the Width of the Access Opening .....	5-53
5-39	Spatial Relationship of Barrier to Adjoining Land Use .....	5-57
7-1	Schematic of a Sound Intensity Probe .....	7-12
7-2	Side-by-Side Microphone Probe .....	7-12
7-3	Sound Power Measurement Area .....	7-13
7-4	Measuring One Piece of Equipment .....	7-24
7-5	Measuring Multiple Pieces of Equipment Operating in Same Area .....	7-25

# Acronyms and Abbreviations

$\Delta$	change
$^{\circ}\text{F}$	degrees Fahrenheit
AASHTO	American Association of State Highway and Transportation Officials
AC	asphalt concrete
ADT	average daily traffic
ANSI	American National Institute of Standards
B	bels
Caltrans	California Department of Transportation
CFR	Code of Federal Regulations
CNEL	community noise equivalent level
cps	cycles per second
dB	decibels
dB/s	decibels per second
dBA	A-weighted decibels
DGAC	dense-graded asphalt concrete
EWNR	Exterior Wall Noise Rating
FHWA	Federal Highway Administration
ft/s	feet per second
GPS	global positioning system
Guidance Manual	Technical Guidance Manual on the Effects on the Assessment and Mitigation of Hydroacoustic Effects of Pile Driving Sound on Fish
Hz	hertz
I-	Interstate
kHz	kilohertz
km/hr	kilometers per hour
kVA	kilovolt-amperes
$L_{dn}$	day-night noise level
$L_{eq}$	equivalent noise level
$L_{max}$	maximum noise level

m/s	meters per second
mph	miles per hour
N	Newton
N/m <sup>2</sup>	Newton per square meter
NAC	noise abatement criteria
NADR	Noise Abatement Decision Report
NIST	National Institute of Standards and Technology
Nm	Newton meter
NRC	noise reduction coefficient
OBSI	on-board sound intensity
OGAC	open-graded asphalt concrete
OSHA	Occupational Safety and Health Administration
PCC	Portland concrete cement
PLD	path length difference
Protocol	Traffic Noise Analysis Protocol
psi	pounds per square inch
pW	picowatt
REMEL	Reference Energy Mean Emission Level
rms	root mean square
SPL	sound pressure level
SR	State Route
STC	Sound Transmission Class
TeNS	Technical Noise Supplement
TL	transmission loss
TNM	Traffic Noise Model
VNTSC	Volpe National Transportation Systems Center
vph	vehicles per hour
W	watts
W/m <sup>2</sup>	watts per square meter
μN/m <sup>2</sup>	microNewtons per square meter
μPa	micro Pascals

# Acknowledgements

- Rudy Hendriks (ICF Jones & Stokes; California Department of Transportation [retired])—principal author
- Bruce Rymer (California Department of Transportation)—technical reviewer
- Jim Andrews (California Department of Transportation)—technical reviewer
- Dave Buehler (ICF International)—technical editor

*Dedication:*

*This edition of the Technical Noise Supplement is dedicated to Rudy Hendriks whose early work substantially contributed to the science of highway acoustics.*

*This page intentionally left blank*

# Section 1

## Introduction and Overview

### 1.1 Introduction

This 2013 Technical Noise Supplement (TeNS) to the California Department of Transportation (Caltrans) *Traffic Noise Analysis Protocol for New Highway Construction, Reconstruction, and Retrofit Barrier Projects* (Protocol) (California Department of Transportation 2011) is an updated version of the 2009 TeNS. This version of the TeNS is compatible with applicable sections of the 2011 Protocol that were prepared in response to changes to Title 23 Part 772 of the Code of Federal Regulations (CFR) which were published in July 2010. The current Protocol was approved by the Federal Highway Administration (FHWA) and became effective on July 13, 2011. Be sure to check for updates to the Protocol.

The purpose of this document is to provide technical background information on transportation-related noise in general and highway traffic noise in particular. It is designed to elaborate on technical concepts and procedures referred to in the Protocol. The contents of the TeNS are for informational purposes; *unless they are referenced in the Protocol, the contents of this document are not official policy, standard, or regulation.* Except for some Caltrans-specific methods and procedures, most methods and procedures recommended in TeNS are in conformance with industry standards and practices.

This document can be used as a stand-alone document for training purposes or as a reference for technical concepts, methodology, and terminology needed to acquire a basic understanding of transportation noise with emphasis on highway traffic noise.

Revisions to this document are listed below.

- Removal of references and discussion relating to traffic noise models that preceded the current FHWA Traffic Noise Model (TNM).

- Abbreviated discussions of several topics such as bioacoustics and quieter pavement that are now covered in more detail in newer technical references.
- Elimination of metric units in accordance with Caltrans current standards. The exception to this is units of pressure that are traditionally expressed in metric units such as micro-pascals.
- Removal of the traffic noise analysis screening procedure which was removed from the Protocol.
- Removal of obsolete information.

The 2009 version of TeNS will remain available on the Caltrans website as a reference for information that has been removed from this edition. The 2009 version of TeNS contains a number of measurement procedures for non-routine noise studies.

## 1.2 Overview

The TeNS consists of eight sections. Except for Section 1, each covers a specific subject of highway noise. A brief description of the subjects follows.

- Section 1, *Introduction and Overview*, summarizes the subjects covered in the TeNS.
- Section 2, *Basics of Highway Noise*, covers the physics of sound as it pertains to characteristics and propagation of highway noise, effects of noise on humans, and ways of describing noise.
- Section 3, *Measurements and Instrumentation*, provides background information on noise measurements, and discusses various noise-measuring instruments and operating procedures.
- Section 4, *Detailed Analysis for Traffic Noise Impacts*, provides guidance for conducting detailed traffic noise impact analysis studies. This section includes identifying land use, selecting receptors, determining existing noise levels, predicting future noise levels, and determining impacts.
- Section 5, *Detailed Analysis for Noise Barrier Design Considerations*, outlines the major aspects that affect the acoustical design of noise barriers, including the dimensions, location, and material; optimization of noise barriers; possible noise reflections; acoustical design of overlapping noise barriers (to provide maintenance access to areas



behind barriers); and drainage openings in noise barriers. Challenges and cautions associated with noise barrier design are also discussed.

- Section 6, *Noise Study Reports*, discusses the contents of noise study reports.
- Section 7, *Non-Routine Considerations and Issues*, covers non-routine situations involving the effects of noise on distant receptors, use of sound intensity and sound power as tools in characterizing sound sources, pavement noise, noise monitoring for insulating facilities, construction noise, earthborne vibrations, California Occupational Safety and Health Administration (OSHA) noise standards, and effects and abatement of transportation-related noise on marine and wildlife.
- Section 8, *Glossary*, provides terminology and definitions common in transportation noise.
- Appendix A, *References Cited*, provides a listing of literature directly cited or used for reference in the TeNS.

*This page intentionally left blank*

## Section 2

# Basics of Highway Noise

The following sections introduce the fundamentals of sound and provide sufficient detail to understand the terminology and basic factors involved in highway traffic noise prediction and analysis. Those who are actively involved in noise analysis are encouraged to seek out more detailed textbooks and reference books to acquire a deeper understanding of the subject.

## 2.1 Physics of Sound

### 2.1.1 Sound, Noise, and Acoustics

Sound is a vibratory disturbance created by a moving or vibrating source in the pressure and density of a gaseous or liquid medium or in the elastic strain of a solid that is capable of being detected by the hearing organs. Sound may be thought of as the mechanical energy of a vibrating object transmitted by pressure waves through a medium to human (or animal) ears. The medium of primary concern is air. In absence of any other qualifying statements, sound is considered airborne sound, as opposed to structure- or earthborne sound, for example.

Noise is defined as sound that is loud, unpleasant, unexpected, or undesired. It therefore may be classified as a more specific group of sounds. Although the terms *sound* and *noise* are often used synonymously, perceptions of sound and noise are highly subjective.

Sound is actually a process that consists of three components: source, path, and receiver. All three components must be present for sound to exist. Without a source, no sound pressure waves would be produced. Similarly, without a medium, sound pressure waves would not be transmitted. Finally, sound must be received—a hearing organ, sensor, or other object must be present to perceive, register, or be affected by sound. In most situations, there are many different sound sources, paths, and receivers.

In the context of an analysis pursuant to 23 CFR 772 the term *receptor* means a single dwelling unit or the equivalent of a single dwelling unit. A *receiver* is a single point that can represent one receptor or multiple receptors. As an example it is common when modeling traffic noise to use a single receiver in the model to represent multiple receptors. Acoustics is the field of science that deals with the production, propagation, reception, effects, and control of sound. The field is very broad, and transportation-related noise and abatement addresses only a small, specialized part of acoustics.

## 2.1.2 Speed of Sound

When the surface of an object vibrates in air, it compresses a layer of air as the surface moves outward and produces a rarefied zone as the surface moves inward. This results in a series of high and low air pressure waves (relative to the steady ambient atmospheric pressure) alternating in sympathy with the vibrations. These pressure waves, not the air itself, move away from the source at the speed of sound, approximately 1,126 feet per second (ft/s) in air with a temperature of 68 degrees Fahrenheit (°F). The speed of sound can be calculated from the following formula:

$$c = \sqrt{1.401 \left( \frac{P}{\rho} \right)} \quad (2-1)$$

Where:

$c$  = speed of sound at a given temperature, in ft/s

$P$  = air pressure in pounds per square foot (pounds/ft<sup>2</sup>)

$\rho$  = air density in slugs per cubic foot (slugs/ft<sup>3</sup>)

1.401 = ratio of the specific heat of air under constant pressure to that of air in a constant volume

For a given air temperature and relative humidity, the ratio  $P/\rho$  tends to remain constant in the atmosphere because the density of air will reduce or increase proportionally with changes in pressure. Therefore, the speed of sound in the atmosphere is independent of air pressure. When air temperature changes,  $\rho$  changes, but  $P$  does not. Therefore, the speed of sound is temperature-dependent, as well as somewhat humidity-dependent because humidity affects the density of air. The effects of the latter with regard to the speed of sound, however, can be ignored for the purposes of the TeNS. The fact that the speed of sound changes with altitude has nothing to do with the change in air pressure and is only caused by the change in temperature.

For dry air of 32°F,  $\rho$  is 0.002509 slugs/ft<sup>3</sup>. At a standard air pressure of 29.92 inches Hg, pressure is 14.7 pounds per square inch (psi) or 2,118 pounds/ft<sup>2</sup>. Using Equation 2-1, the speed of sound for standard pressure and temperature can be calculated as follows:

$$c = \sqrt{(1.401)\left(\frac{2,118}{0.002509}\right)} = 1,087 \text{ ft/s.}$$

From this base value, the variation with temperature is described by the following equation:

$$c = 1051.3 \sqrt{1 + \frac{T_r}{459.7}} \text{ ft/s} \quad (2-2)$$

Where:

$c$  = speed of sound

$T_r$  = temperature in degrees Fahrenheit (include minus sign for less than 0°F)

The above equations show that the speed of sound increases or decreases as the air temperature increases or decreases, respectively. This phenomenon plays an important role in the atmospheric effects on noise propagation, specifically through the process of refraction, which is discussed in Section 2.1.4.3.

## 2.1.3 Sound Characteristics

In its most basic form, a continuous sound can be described by its frequency or wavelength (pitch) and amplitude (loudness).

### 2.1.3.1 Frequency, Wavelength, and Hertz

For a given single pitch, the sound pressure waves are characterized by a sinusoidal periodic (i.e., recurring with regular intervals) wave, as shown in Figure 2-1. The upper curve shows how sound pressure varies above and below the ambient atmospheric pressure with distance at a given time. The lower curve shows how particle velocity varies above 0 (molecules moving right) and below 0 (molecules moving left). Please note that when the pressure fluctuation is at 0, the particle velocity is at its maximum, either in the positive or negative direction; when the pressure is at its positive or negative peak, the particle velocity is at 0. Particle velocity describes the motion of the air molecules in response to the pressure

waves. It does not refer to the velocity of the waves, otherwise known as the speed of sound. The distance ( $\lambda$ ) between crests of both curves is the wavelength of the sound.

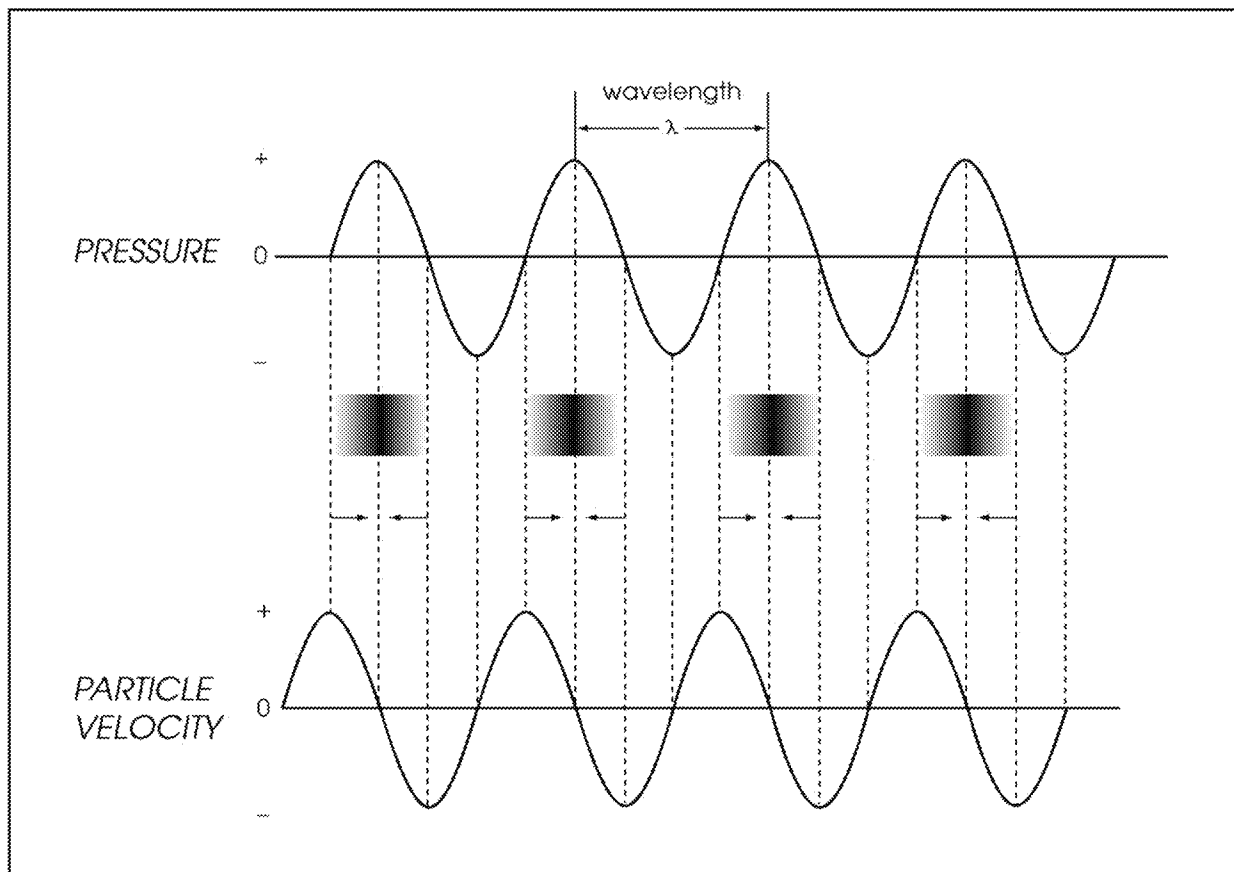
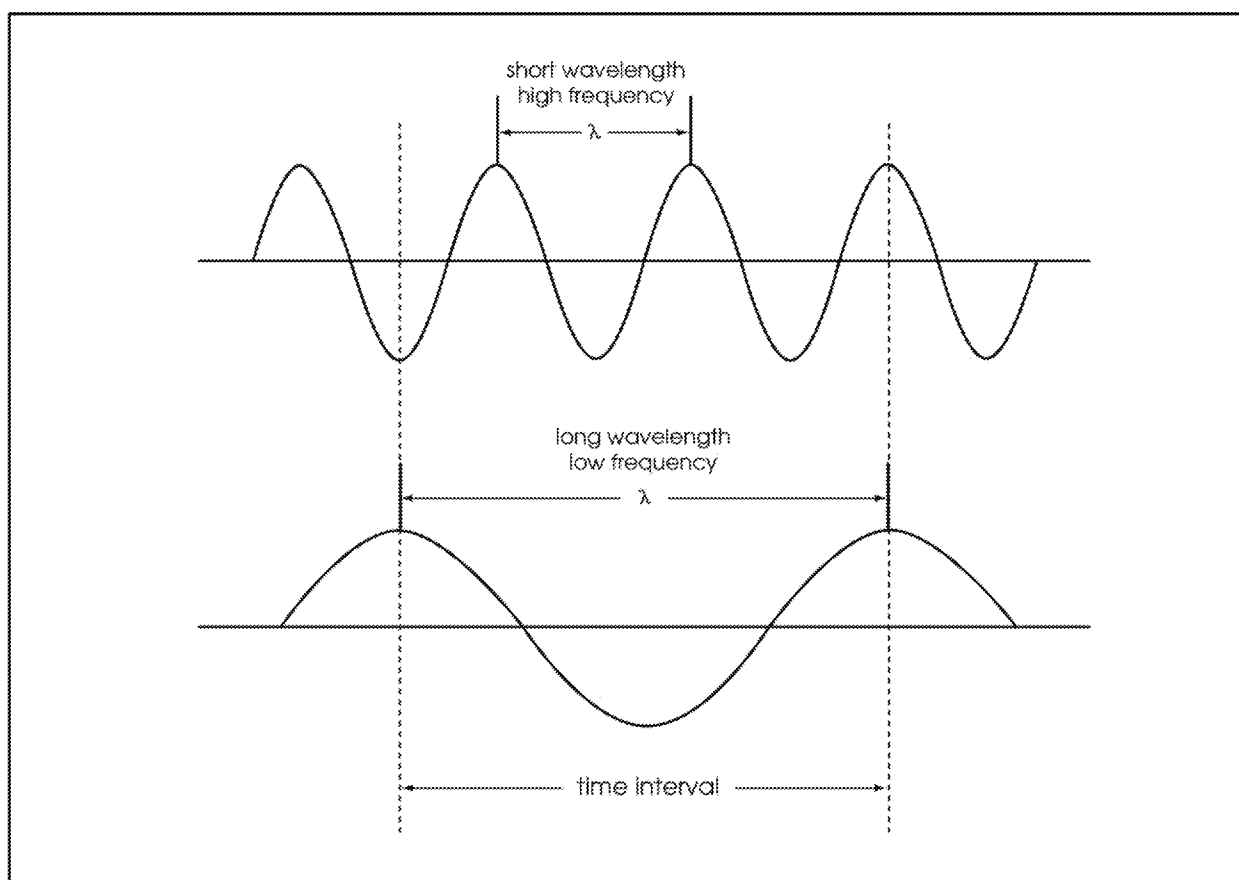

**Figure 2-1.** Sound Pressure vs. Particle Velocity

The number of times per second that the wave passes from a period of compression through a period of rarefaction and starts another period of compression is referred to as the frequency of the wave (Figure 2-2). Frequency is expressed in cycles per second, or hertz (Hz): 1 Hz equals one cycle per second. High frequencies are sometimes more conveniently expressed in units of kilohertz (kHz) or thousands of hertz. The extreme range of frequencies that can be heard by the healthiest human ears spans from 16 to 20 Hz on the low end to about 20,000 Hz (20 kHz) on the high end. Frequencies are heard as the pitch or tone of sound. High-pitched sounds produce high frequencies, and low-pitched sounds produce low frequencies. Very-low-frequency airborne sound of sufficient amplitude may be felt before it can be heard and is often confused with earthborne vibrations. Sound less than 16 Hz is referred to as infrasound, while high frequency sound above 20,000 Hz is called ultrasound. Both infrasound and ultrasound are not audible to humans, but many animals can hear or sense frequencies extending well into one or both of these regions.

Ultrasound also has various applications in industrial and medical processes, specifically cleaning, imaging, and drilling.

The distance traveled by a sound pressure wave through one complete cycle is referred to as the wavelength. The duration of one cycle is called the period. The period is the inverse of the frequency. For example, the frequency of a series of waves with periods of 0.05 (1/20) second is 20 Hz; a period of 0.001 (1/1000) second is 1,000 Hz or 1 kHz. Although low frequency earthborne vibrations (e.g., earthquakes and swaying of bridges or other structures) often are referred to by period, the term rarely is used in expressing airborne sound characteristics.



**Figure 2-2.** Frequency and Wavelength

Figure 2-2 shows that as the frequency of a sound pressure wave increases, its wavelength decreases, and vice versa. The relationship between frequency and wavelength is linked by the speed of sound, as shown in the following equations:

$$\lambda = \frac{c}{f} \quad (2-3)$$

$$f = \frac{c}{\lambda} \quad (2-4)$$

$$c = f\lambda \quad (2-5)$$

Where:

$\lambda$  = wavelength ( feet)

$c$  = speed of sound (1,126.5 ft/s at 68°F)

$f$  = frequency (Hz)

In these equations, care must be taken to use the same units (distance units in feet and time units in seconds) for wavelength and speed of sound.

Although the speed of sound is usually thought of as a constant, it has been shown that it actually varies with temperature. These mathematical relationships hold true for any value of the speed of sound. Frequency normally is generated by mechanical processes at the source (e.g., wheel rotation, back and forth movement of pistons) and therefore is not affected by air temperature. As a result, wavelength usually varies inversely with the speed of sound as the latter varies with temperature.

The relationships between frequency, wavelength, and speed of sound can be visualized easily by using the analogy of a train traveling at a given constant speed. Individual boxcars can be thought of as the sound pressure waves. The speed of the train (and individual boxcars) is analogous to the speed of sound, while the length of each boxcar is the wavelength. The number of boxcars passing a stationary observer each second depicts the frequency ( $f$ ). If the value of the latter is 2, and the speed of the train ( $c$ ) is 68 miles per hour (mph), or 100 ft/s, the length of each boxcar ( $\lambda$ ) must be:  $c/f = 100/2 = 50$  feet.

Using Equation 2-3, a table can be developed showing frequency and associated wavelength. Table 2-1 shows the frequency and wavelength relationship at an air temperature of 68°F.

**Table 2-1. Wavelength of Various Frequencies**

Frequency (Hz)	Wavelength at 68°F (Feet)
16	70
31.5	36
63	18
125	9
250	4.5
500	2.3



Frequency (Hz)	Wavelength at 68°F (Feet)
1,000	1.1
2,000	0.56
4,000	0.28
8,000	0.14
16,000	0.07

The validity of Table 2-1 can be checked by multiplying each frequency by its wavelength, which should equal the speed of sound. Please notice that because of rounding, multiplying frequency and wavelength gives varying results for the speed of sound in air, which for 68°F should be constant at 1,126.5 ft/s.

Frequency is an important component of noise analysis. Virtually all acoustical phenomena are frequency-dependent, and knowledge of frequency content is essential. Sections 2.1.3.6 and 2.1.3.7 discuss how frequency is considered in sound level measurements and sound analysis.

### 2.1.3.2 Sound Pressure Levels and Decibels

As indicated in Figure 2-1, the pressures of sound waves continuously change with time or distance and within certain ranges. The ranges of these pressure fluctuations (actually deviations from the ambient air pressure) are referred to as the amplitude of the pressure waves. Whereas the frequency of the sound waves is responsible for the pitch or tone of a sound, the amplitude determines the loudness of the sound. Loudness of sound increases and decreases with the amplitude.

Sound pressures can be measured in units of microNewtons per square meter ( $\mu\text{N}/\text{m}^2$ ), also called micro Pascals ( $\mu\text{Pa}$ ): 1  $\mu\text{Pa}$  is approximately one-hundred-billionth ( $1/100,000,000,000$ ) of the normal atmospheric pressure. The pressure of a very loud sound may be 200 million  $\mu\text{Pa}$ , or 10 million times the pressure of the weakest audible sound (20  $\mu\text{Pa}$ ).

Expressing sound levels in terms of  $\mu\text{Pa}$  would be very cumbersome because of this wide range. Sound pressure levels (SPLs) are described in logarithmic units of ratios of actual sound pressures to a reference pressure squared called bels. To provide a finer resolution, a bel is divided into tenths, or decibels (dB). In its simplest form, SPL in decibels is expressed as follows:

$$\text{Sound pressure level (SPL)} = 10\log_{10} \left( \frac{p_1}{p_0} \right)^2 \text{ dB} \quad (2-6)$$

Where:

$P_1$  = sound pressure

$P_0$  = reference pressure, standardized as 20  $\mu\text{Pa}$

The standardized reference pressure,  $P_0$ , of 20  $\mu\text{Pa}$  corresponds to the threshold of human hearing. When the actual sound pressure is equal to the reference pressure, the expression results in a sound level of 0 dB:

$$10\log_{10} \left( \frac{p_1}{p_0} \right)^2 = 10\log_{10}(1) = 0 \text{ dB}$$

Please note that 0 dB does not represent an absence of any sound pressure. Instead, it is an extreme value that only those with the most sensitive ears can detect. Therefore, it is possible to refer to sounds as less than 0 dB (negative dB) for sound pressures that are weaker than the threshold of human hearing. For most people, the threshold of hearing is probably close to 10 dB.

### 2.1.3.3 Root Mean Square and Relative Energy

Figure 2-1 depicted a sinusoidal curve of pressure waves. The values of the pressure waves were constantly changing, increasing to a maximum value above normal air pressure, then decreasing to a minimum value below normal air pressure, in a repetitive fashion. This sinusoidal curve is associated with a single frequency sound, also called a pure tone. Each successive sound pressure wave has the same characteristics as the previous wave. The amplitude characteristics of such a series of simple waves then can be described in various ways, all of which are simply related to each other. The two most common ways to describe the amplitude of the waves is in terms of peak SPL and root mean square (rms) SPL.

Peak SPL simply uses the maximum or peak amplitude (pressure deviation) for the value of  $P_1$  in Equation 2-6. Therefore, peak SPL only uses one value (absolute value of peak pressure deviation) of the continuously changing amplitudes. The rms value of the wave amplitudes (pressure deviations) uses all positive and negative instantaneous amplitudes, not just the peaks. It is derived by squaring the positive and negative instantaneous pressure deviations, adding these together, and dividing the sum by the number of pressure deviations. The result is called

the mean square of the pressure deviations; the square root of this mean value is the rms value. Figure 2-3 shows the peak and rms relationship for sinusoidal or single-frequency waves. The rms is 0.707 times the peak value.

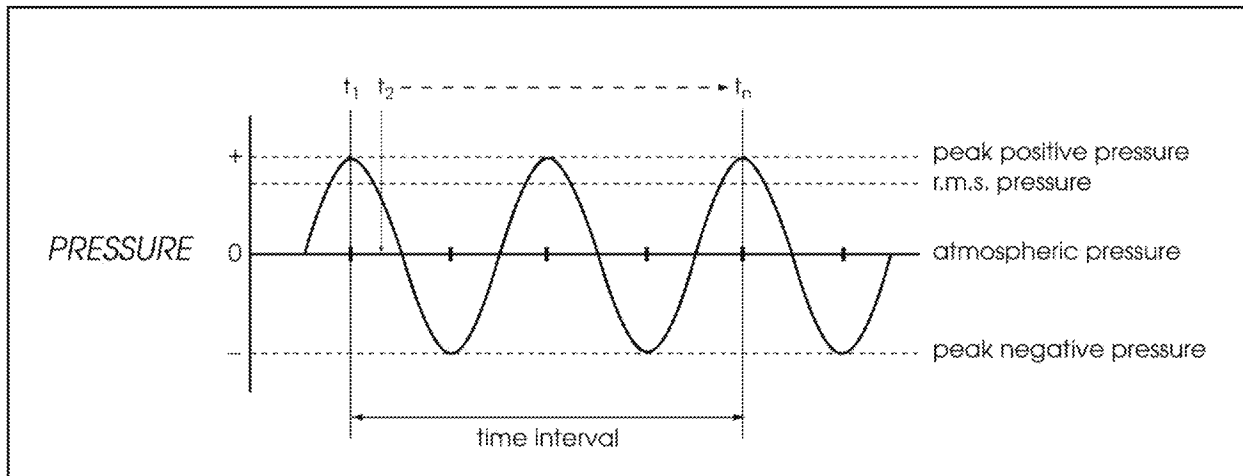

**Figure 2-3. Peak and Root Mean Square Sound Pressure**

In terms of discrete samples of the pressure deviations, the mathematical expression is as follows:

$$\text{rms} = \sqrt{(\sum^n (t_1^2 + t_2^2 + \dots + t_n^2)/n)} \quad (2-7)$$

Where:

$t_1, t_2, \dots, t_n$  = discrete pressure values at times  $t_1$  through  $t_n$  above (positive) and below (negative) the local atmospheric pressure

Sound pressures expressed in rms are proportional to the energy contents of the waves and are therefore the most important and often used measure of amplitude. Unless indicated otherwise, all SPLs are expressed as rms values.

#### **2.1.3.4 Relationship between Sound Pressure Level, Relative Energy, Relative Pressure, and Pressure**

Table 2-2 shows the relationship between rms SPL, relative sound energy, relative sound pressure, and pressure. Please note that SPL, relative energy, and relative pressure are based on a reference pressure of 20  $\mu\text{Pa}$  and by definition are all referenced to 0 dB. The pressure values are the actual rms pressure deviations from local ambient atmospheric pressure.

The most useful relationship is that of SPL (dB) and relative energy. Relative energy is unitless. Table 2-2 shows that for each 10 dB increase in SPL the acoustic energy increases tenfold (e.g., an SPL increase from 60 to 70 dB increases the energy 10 times). Acoustic energy can be thought of as the energy intensity (energy per unit area) of a certain noise source, such as a heavy truck, at a certain distance. For example, if one heavy truck passing by an observer at a given speed and distance produces an SPL of 80 A-weighted decibels (dBA), the SPL of 10 heavy trucks identical to the single truck would be 90 dBA if they all could simultaneously occupy the same space and travel at the same speed and distance from the observer.

Because SPL is computed using  $10\log_{10}(P_1/P_2)^2$ , the acoustic energy is related to SPL as follows:

$$(P_1/P_2)^2 = 10^{\text{SPL}/10} \quad (2-8)$$

**Table 2-2.** Relationship between Sound Pressure Level, Relative Energy, Relative Pressure, and Sound Pressure

Sound Pressure Level (dB)	Relative Energy	Relative Pressure	Sound Pressure ( $\mu\text{Pa}$ )
$10\log_{10}\left(\frac{P_1}{P_0}\right)^2$	$\left(\frac{P_1}{P_0}\right)^2$	$\left(\frac{P_1}{P_0}\right)$	( $P_1$ )
200	$10^{20}$	$10^{10}$	
154			$10^9$ (1,000 Pa)
150	$10^{15}$		
140	$10^{14}$	$10^7$	
134			$10^8$ (100 Pa)
130	$10^{13}$		
120	$10^{12}$	$10^6$	
114			$10^7$ (10 Pa)
110	$10^{11}$		
100	$10^{10}$	$10^5$	
94			$10^6$ (1 Pa)
90	$10^9$		
80	$10^8$	$10^4$	
74			$10^5$ $\mu\text{Pa}$
70	$10^7$		
60	$10^6$	$10^3$	
54			$10^4$ $\mu\text{Pa}$
50	$10^5$		
40	$10^4$	$10^2$	

Sound Pressure Level (dB)	Relative Energy	Relative Pressure	Sound Pressure ( $\mu\text{Pa}$ )
$10\log_{10}\left(\frac{P_1}{P_0}\right)^2$	$\left(\frac{P_1}{P_0}\right)^2$	$\left(\frac{P_1}{P_0}\right)$	$(P_1)$
34			$10^3 \mu\text{Pa}$
30	$10^3$		
20	$10^2$	$10^1$	
14			$10^2 \mu\text{Pa}$
10	$10^1$		
0	$10^0 = 1 = \text{Ref.}$	$10^0 = 1 = \text{Ref.}$	$P_1 = P_0 = 20 \mu\text{Pa}$

### 2.1.3.5 Adding, Subtracting, and Averaging Sound Pressure Levels

Because decibels are logarithmic units, SPL cannot be added or subtracted by ordinary arithmetic means. For example, if one automobile produces an SPL of 70 dB when it passes an observer, two cars passing simultaneously would not produce 140 dB; they would combine to produce 73 dB. The following discussion provides additional explanation of this concept. The SPL from any source observed at a given distance from the source may be expressed as  $10\log_{10}(P_1/P_0)^2$  (see Equation 2-6). Therefore, the SPL from two equal sources at the same distance would be calculated as follows:

$$\text{SPL} = 10\log_{10} [(P_1/P_0)^2 + (P_1/P_0)^2] = 10\log_{10}[2(P_1/P_0)^2]$$

This can be simplified as  $10\log_{10}(2) + 10\log_{10}(P_1/P_0)^2$ . Because the logarithm of 2 is 0.301, and 10 times that would be 3.01, the sound of two equal sources is 3 dB more than the sound level of one source. The total SPL of the two automobiles therefore would be  $70 + 3 = 73$  dB.

### Adding and Subtracting Equal Sound Pressure Levels

The previous example of adding the noise levels of two cars may be expanded to any number of sources. The previous section described the relationship between decibels and relative energy. The ratio  $(P_1/P_0)^2$  is the relative (acoustic) energy portion of the expression  $\text{SPL} = 10\log_{10}(P_1/P_0)^2$ , in this case the relative acoustic energy of one source. This must immediately be qualified with the statement that this is not the acoustic power output of the source. Instead, the expression is the relative acoustic energy per unit area received by the observer. It may be stated that  $N$  identical automobiles or other noise sources would yield an SPL calculated as follows:

$$SPL_{Total} = SPL_1 + 10\log_{10}(N) \quad (2-9)$$

Where:

$SPL_1$  = SPL of one source

N = number of identical sources to be added (must be more than 0)

Example

If one noise source produces 63 dB at a given distance, what would be the noise level of 13 of the same source combined at the same distance?

Solution

$$SPL_{Total} = 63 + 10\log_{10}(13) = 63 + 11.1 = 74.1 \text{ dB}$$

Equation 2-9 also may be rewritten as follows. This form is useful for subtracting equal SPLs:

$$SPL_1 = SPL_{Total} - 10\log_{10}(N) \quad (2-10)$$

Example

The SPL of six equal sources combined is 68 dB at a given distance. What is the noise level produced by one source?

Solution

$$SPL_1 = 68 \text{ dB} - 10\log_{10}(6) = 68 - 7.8 = 60.2 \text{ dB}$$

In these examples, adding equal sources actually constituted multiplying one source by the number of sources. Conversely, subtracting equal sources was performed by dividing the total. For the latter, Equation 2-9 could have been written as  $SPL_1 = SPL_{Total} + 10\log_{10}(1/N)$ . The logarithm of a fraction yields a negative result, so the answers would have been the same.

These exercises are very useful for estimating traffic noise impacts. For example, if one were to ask what the respective SPL increases would be along a highway if existing traffic were doubled, tripled, or quadrupled (assuming traffic mix, distribution, and speeds would not change), a reasonable prediction could be made using Equation 2-9. In this case, N would be the existing traffic (N = 1); N = 2 would be doubling, N = 3 would be tripling, and N = 4 would be quadrupling the existing traffic. Because  $10\log_{10}(N)$  in Equation 2-9 represents the increase in SPL, the above values for N would yield +3, +4.8, and +6 dB, respectively.

Similarly, one might ask what the SPL decrease would be if traffic were reduced by a factor of 2, 3, or 4 (i.e., N = 1/2, N = 1/3, and N = 1/4, respectively). Applying  $10\log_{10}(N)$  to these values would yield -3, -5, and -6 dB, respectively.

The same problem also may arise in a different form. For example, the traffic flow on a given facility is 5,000 vehicles per hour, and the SPL is 65 dB at a given location next to the facility. One might ask what the expected SPL would be if future traffic increased to 8,000 vehicles per hour. The solution would be:

$$65 + 10\log_{10}(8,000/5,000) = 65 + 2 = 67 \text{ dB.}$$

Therefore,  $N$  may represent an integer, fraction, or ratio. However,  $N$  always must be more than 0. Taking the logarithm of 0 or a negative value is not possible.

In Equations 2-9 and 2-10,  $10\log_{10}(N)$  was the increase from  $SPL_1$  to  $SPL_{Total}$  and equals the change in noise levels from an increase or decrease in equal noise sources. Letting the change in SPLs be referred to as  $\Delta SPL$ , Equations 2-9 and 2-10 can be rewritten as follows:

$$\Delta SPL = 10\log_{10}(N) \quad (2-11)$$

This equation is useful for calculating the number of equal source increments ( $N$ ) that must be added or subtracted to change noise levels by  $\Delta SPL$ . For example, if it is known that an increase in traffic volumes increases SPL by 7 dB, the factor change in traffic (assuming that traffic mix and speeds did not change) can be calculated as follows:

$$7 \text{ dB} = 10\log_{10}(N)$$

$$0.7 \text{ dB} = \log_{10}(N)$$

$$10^{0.7} = N$$

$$N = 5.0$$

Therefore, the traffic volume increased by a factor of 5.

## Adding and Subtracting Unequal Sound Pressure Levels

If noise sources are not equal or equal noise sources are at different distances,  $10\log_{10}(N)$  cannot be used. Instead, SPLs must be added or subtracted individually using the SPL and relative energy relationship in Equation 2-8. If the number of SPLs to be added is  $N$ , and  $SPL_1$ ,  $SPL_2$ , and  $SPL_n$  represent the first, second, and  $n$ th SPL, respectively, the addition is accomplished as follows:

$$\text{SPL}_{\text{Total}} = 10\log_{10}[10^{\text{SPL}_1/10} + 10^{\text{SPL}_2/10} + \dots + 10^{\text{SPL}_n/10}] \quad (2-12)$$

The above equation is the general equation for adding SPLs. The equation also may be used for subtraction (simply change “+” to “-”). However, the result between the brackets must always be more than 0. For example, determining the total SPL of 82, 75, 88, 68, and 79 dB would use Equation 2-12 as follows:

$$\text{SPL} = 10\log_{10} (10^{68/10} + 10^{75/10} + 10^{79/10} + 10^{82/10} + 10^{88/10}) = 89.6 \text{ dB}$$

### Adding Sound Pressure Levels Using a Simple Table

When combining sound levels, a table such as the following may be used as an approximation.

**Table 2-3.** Decibel Addition

When Two Decibel Values Differ by:	Add This Amount to the Higher Value:	Example:
0 or 1 dB	3 dB	70 + 69 = 73 dB
2 or 3 dB	2 dB	74 + 71 = 76 dB
4 to 9 dB	1 dB	66 + 60 = 67 dB
10 dB or more	0 dB	65 + 55 = 65 dB

This table yields results within about 1 dB of the mathematically exact value and can be memorized easily. The table can also be used to add more than two SPLs. First, the list of values should be sorted, from lowest to highest. Then, starting with the lowest values, the first two should be combined, the result should be added to the third value, and so on until only the answer remains. For example, to determine the sum of the sound levels used in the preceding example using Table 2-3, the first step would be to rank the values from low to high: 68, 75, 79, 82, and 88 dB.

Using Table 2-3, the first two noise levels then should be added. The result then would be added to the next noise level, etc., as follows:

$$\begin{aligned} 68 + 75 &= 76, \\ 76 + 79 &= 81, \\ 81 + 82 &= 85, \\ 85 + 88 &= 90 \text{ dB} \end{aligned}$$

For comparison, using Equation 2-12, total SPL was 89.6 dB.

Two decibel-addition rules are important. First, when adding a noise level to an approximately equal noise level, the total noise level increases 3 dB.



For example, doubling the traffic on a highway would result in an increase of 3 dB. Conversely, reducing traffic by one half would reduce the noise level by 3 dB. Second, when two noise levels are 10 dB or more apart, the lower value does not contribute significantly (less than 0.5 dB) to the total noise level. For example,  $60 + 70 \text{ dB} \approx 70 \text{ dB}$ . This means that if a noise level measured from a source is at least 70 dB, the background noise level (without the target source) must not be more than 60 dB to avoid risking contamination.

## Averaging Sound Pressure Levels

There are two ways of averaging SPLs: arithmetic averaging and energy-averaging. Arithmetic averaging is simply averaging the decibel values. For example, the arithmetic average (mean) of 60 and 70 dB is:

$$(60 + 70)/2 = 65 \text{ dB}$$

Energy averaging is averaging of the energy values. Using the previous example, the energy average (mean) of 60 and 70 dB is:

$$10\log[(10^{6.0} + 10^{7.0})/2] = 67.4 \text{ dB}$$

Please notice that the energy average is always equal to or more than the arithmetic average. It is only equal to the arithmetic average if all values are the same. Averaging the values 60, 60, 60, and 60 dB yields equal results of 60 dB in both cases. The following discussion shows some examples of when each method is appropriate.

### Energy Averaging

Energy averaging is the most widely used method of averaging noise levels. Sound energy relates directly to the sound source. For example, at a given distance the sound energy from six equal noise sources is three times that of two of the same sources at that same distance. To average the number of sources and calculate the associated noise level, energy averaging should be used. Examples of applications of energy averaging are provided below.

#### Example 1

To determine the average noise level at a specific receiver along a highway between 6 a.m. and 7 a.m., five 1-hour measurements were taken on random days during that hour. The energy-averaged measurement results were 68, 67, 71, 70, and 71 dB. What is a good estimate of the noise level at that receiver? Because the main reason for the fluctuations in noise levels is probably the differences in source strength (vehicle mix,

volumes, and speeds), energy averaging is appropriate. Therefore, the result would be:  $10\log[(10^{6.8} + 10^{6.7} + 10^{7.1} + 10^{7.0} + 10^{7.1})/5] = 69.6$  dB, or 70 dB.

### Example 2

Another situation is where traffic volumes substantially change during a measurement period. Noise is measured at a location along a highway. Vehicles on that highway are distributed equally, are traveling at the same speed, and are of the same type (e.g., automobiles). Such traffic characteristics would produce a near steady-state noise level. The typical procedure would be to measure the traffic noise for an hour. After 15 minutes, the traffic volume suddenly increases sharply, but speeds remain the same and the vehicles, although closer together, are still equally distributed for the remaining 45 minutes. The noise level during the first 15 minutes was 70 dB and during the last 45 minutes was 75 dB. What was the energy-averaged noise level? Because the time periods were not the same, the energy average must be time-weighted by using the following equation:

$$\text{Energy-averaged noise level} = 10\log[(15 * 10^{7.0} + 45 * 10^{7.5})/60] = 74.2 \text{ dB}$$

In this example, the time was weighted in units of minutes. This also could have been accomplished using fractions of 1 hour, as follows:

$$\text{Energy-averaged noise level} = 10\log[(0.25 * 10^{7.0} + 0.75 * 10^{7.5})/1] = 74.2 \text{ dB}$$

### **Arithmetic Averaging**

Arithmetic averaging is used less frequently, but it is used in situations such as the following. For example, the objective is to measure the noise of a machine with great accuracy. For simplicity, assume that the machine produces a steady noise level, which is expected to be constant, each time the machine is turned on. Because accuracy is of great importance, it is chosen to take repeat measurements with different sound level meters and to calculate the average noise level. In this case, it is appropriate to calculate the arithmetic mean by adding the measured decibel values and dividing by the number of measurements. Because the same source is measured repeatedly, any measured noise fluctuations are mainly from errors inherent in the instrumentation; method of measurement; environmental conditions; and, to a certain extent, source strength. Because the errors are distributed randomly, the expected value of the measurements is the arithmetic mean.

It is also appropriate to use arithmetic means for statistical comparisons of noise levels, or hypothesis testing, whether the noise levels were obtained

by energy averaging or arithmetic means. Examples of applications of arithmetic averaging are provided below.

#### Example 1

In this example the objective is to compare the noise levels from Compressors A and B. It is decided to take five independent noise measurements at 25 feet from each compressor. Between each measurement, the compressors will be shut off and restarted. The following data are collected:

Compressor	Measured Noise Levels (dB)	Arithmetic Average (dB)
A	75, 76, 73, 74, 75	$(75+76+73+74+75)/5 = 74.6$
B	77, 75, 76, 78, 75	$(77+75+76+78+75)/5 = 76.2$

In addition, the hypothesis that Compressors A and B emit the same noise can be tested by calculating the standard deviations and using appropriate statistical tests assuming a certain level of significance. However, this is not the subject of discussion in this case.

#### Example 2

Residents A and B live next to the same highway. Resident A complains about the noise at night, while Resident B does not. One wishes to determine whether the nighttime noise level is higher at Residence A than Residence B. Four hours at night are randomly selected, and simultaneous energy-averaged noise measurements are taken at Residences A and B during the 4 hours. The measurement results are:

Hour	Residence A (dB)	Residence B (dB)
1	65	62
2	62	58
3	63	59
4	66	63
Arithmetic mean	64.0	60.5

The goal is a statistical comparison of noise levels at Residences A and B for the same randomly selected time periods, as well as the same traffic and environmental conditions. Although the 1-hour noise levels represent energy averages for each hour, arithmetic means should be calculated for the statistical comparison, as shown in the preceding measurement results.

The hypothesis that noise levels at Residence A equal noise levels at Residence B can be tested using the standard deviations, as well as the appropriate tests and significance levels. Please note, however, that statistical significance has no relationship to human significance. In this

example, the noise level at Residence A is probably significantly higher statistically than at Residence B. In terms of human perception, however, the difference may be barely perceptible.

A good rule to remember is that whenever measurements or calculations must relate to the number of sources or source strength, energy averaging should be used. However, if improving accuracy in measurements or calculations of the same events or making statistical comparisons is the goal, the arithmetic mean is appropriate. Additional details about averaging and time-weighting are addressed in Section 2.2.2.

### 2.1.3.6 A-Weighting and Noise Levels

SPL alone is not a reliable indicator of loudness. Frequency or pitch also has a substantial effect on how humans respond. While the intensity (energy per unit area) of the sound is a purely physical quantity, loudness or human response depends on the characteristics of the human ear.

Human hearing is limited not only to the range of audible frequencies, but also in the way it perceives the SPL in that range. In general, the healthy human ear is most sensitive to sounds between 1,000 and 5,000 Hz and perceives both higher and lower frequency sounds of the same magnitude with less intensity. To approximate the frequency response of the human ear, a series of SPL adjustments is usually applied to the sound measured by a sound level meter. The adjustments, or weighting network, are frequency-dependent.

The A-scale approximates the frequency response of the average young ear when listening to most everyday sounds. When people make relative judgments of the loudness or annoyance of a sound, their judgments correlate well with the A-scale sound levels of those sounds. There are other weighting networks that have been devised to address high noise levels or other special problems (e.g., B-, C-, D-scales), but these scales rarely, if ever, are used in conjunction with highway traffic noise. Noise levels for traffic noise reports should be reported as dBA. In environmental noise studies, A-weighted SPLs commonly are referred to as noise levels.

Figure 2-4 shows the A-scale weighting network that is normally used to approximate human response. The 0-dB line represents a reference line; the curve represents frequency-dependent attenuations provided by the ear's response. Table 2-4 shows the standardized values (American National Standards Institute 1983). The use of this weighting network is signified by appending an "A" to the SPL as dBA or dB(A).

The A-weighted curve was developed from averaging the statistics of many psychoacoustic tests involving large groups of people with normal hearing in the age group of 18 to 25 years. The internationally standardized curve is used worldwide to address environmental noise and is incorporated in virtually all environmental noise descriptors and standards. Section 2.2.2 addresses the most common descriptors applicable to transportation noise.

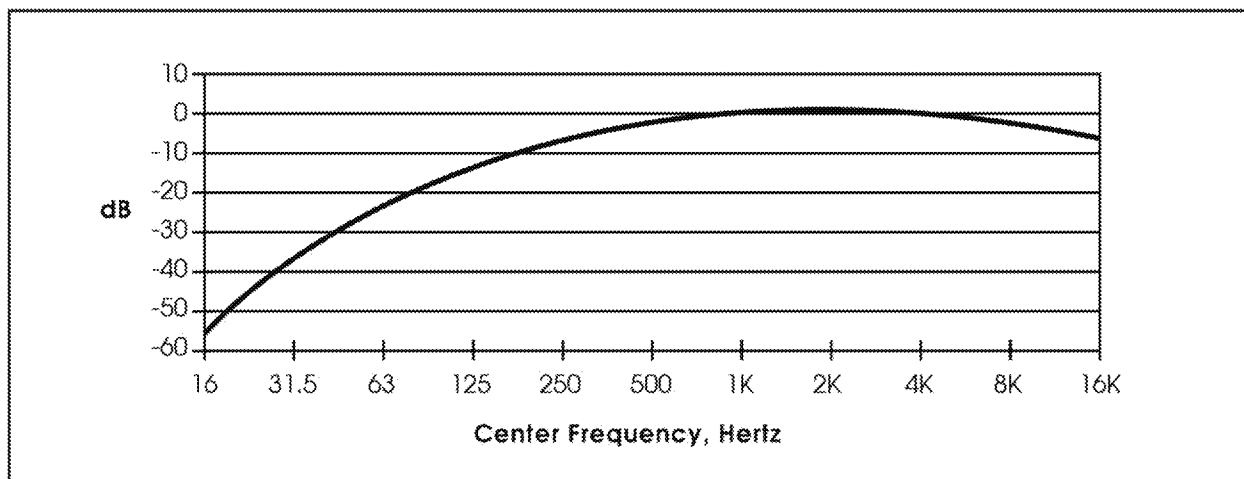

**Figure 2-4.** A-Weighting Network

**Table 2-4.** A-Weighting Adjustments for One-Third-Octave Center Frequencies

Frequency (Hz)	A-Weighting (dB)	Frequency (Hz)	A-Weighting (dB)	Frequency (Hz)	A-Weighting (dB)	Frequency (Hz)	A-Weighting (dB)
16	-56.7	100	-19.1	630	-1.9	4,000	+1.0
20	-50.5	125	-16.1	800	-0.8	5,000	+0.5
25	-44.7	160	-13.4	1,000	0	6,300	-0.1
31.5	-39.4	200	-10.9	1,250	+0.6	8,000	-1.1
40	-34.6	250	-8.6	1,600	+1.0	10,000	-2.5
50	-30.6	315	-6.6	2,000	+1.2	12,500	-4.3
63	-26.2	400	-4.8	2,500	+1.3	16,000	-6.6
80	-22.5	500	-3.2	3,150	+1.2	20,000	-9.3

Source: American National Standards Institute 1983.

Sound level meters used for measuring environmental noise have an A-weighting network built in for measuring A-weighted sound levels. This is accomplished through electronic filters, also called band pass filters. Each filter allows the passage of a selected range (band) of frequencies only and

attenuates its SPL to modify the frequency response of the sound level meter to about that of the A-weighted curve and the human ear.

A range of noise levels associated with common indoor and outdoor activities is shown in Table 2-5. The decibel scale is open-ended. As discussed, 0 dB or 0 dBA should not be construed as the absence of sound. Instead, it is the generally accepted threshold of the best human hearing. SPLs in negative decibel ranges are inaudible to humans. On the other extreme, the decibel scale can go much higher than shown in Table 2-5. For example, gunshots, explosions, and rocket engines can reach 140 dBA or higher at close range. Noise levels approaching 140 dBA are nearing the threshold of pain. Higher levels can inflict physical damage on such things as structural members of air and spacecraft and related parts. Section 2.2.1.1 discusses the human response to changes in noise levels.

**Table 2-5. Typical Noise Levels**

<b>Common Outdoor Activities</b>	<b>Noise Level (dBA)</b>	<b>Common Indoor Activities</b>
	<b>110</b>	Rock band
Jet flyover at 1,000 feet		
	<b>100</b>	
Gas lawnmower at 3 feet		
	<b>90</b>	
Diesel truck at 50 feet at 50 mph		Food blender at 3 feet
	<b>80</b>	Garbage disposal at 3 feet
Noisy urban area, daytime		
Gas lawnmower, 100 feet	<b>70</b>	Vacuum cleaner at 10 feet
Commercial area		Normal speech at 3 feet
Heavy traffic at 300 feet	<b>60</b>	
		Large business office
Quiet urban daytime	<b>50</b>	Dishwasher in next room
Quiet urban nighttime	<b>40</b>	Theater, large conference room (background)
Quiet suburban nighttime		
	<b>30</b>	Library
		Bedroom at night, concert hall (background)
Quiet rural nighttime	<b>20</b>	
		Broadcast/recording studio
	<b>10</b>	
	<b>0</b>	

### 2.1.3.7 Octave and One-Third-Octave Bands and Frequency Spectra

Very few sounds are pure tones (i.e., consisting of a single frequency). To represent the complete characteristics of a sound properly, it is necessary to divide the total sound into its frequency components (i.e., determine how much sound [SPL] comes from each of the multiple frequencies that make up the sound). This representation of frequency vs. SPL is called a frequency spectrum. Spectra usually consist of 8- to 10-octave bands, more or less spanning the frequency range of human hearing (20 to 20,000 Hz). Just as with a piano keyboard, an octave represents the frequency interval between a given frequency and twice that frequency. Octave bands are internationally standardized and identified by their “center frequencies” (geometric means).

Because octave bands are rather broad, they are frequently subdivided into thirds to create one-third-octave bands. These are also standardized. For convenience, one-third-octave bands are sometimes numbered from 1 (1.25-Hz one-third-octave center frequency, which cannot be heard by humans) to 43 (20,000-Hz one-third-octave center frequency). Within the extreme range of human hearing there are 30 one-third-octave bands ranging from band 13 (20-Hz one-third-octave center frequency) to band 42 (16,000-Hz one-third-octave center frequency). Table 2-6 shows the ranges of the standardized octave and one-third-octave bands, as well as band numbers.

Frequency spectra are used in many aspects of sound analysis, from studying sound propagation to designing effective noise control measures. Sound is affected by many frequency-dependent physical and environmental factors. Atmospheric conditions, site characteristics, and materials and their dimensions used for sound reduction are some of the most important examples.

Sound propagating through the air is affected by air temperature, humidity, wind and temperature gradients, vicinity and type of ground surface, obstacles, and terrain features. These factors are all frequency-dependent.

The ability of a material to transmit noise depends on the type of material (concrete, wood, glass, etc.) and its thickness. Effectiveness of different materials at transmitting noise depends on the frequency of the noise. See Section 5.1.1 for a discussion of transmission loss and sound transmission class.

Wavelengths serve to determine the effectiveness of noise barriers. Low frequency noise, with its long wavelengths, passes easily around and over

a noise barrier with little loss in intensity. For example, a 16-Hz noise with a wavelength of 70 feet will tend to pass over a 16-foot-high noise barrier. Fortunately, A-weighted traffic noise tends to dominate in the 250- to 2,000-Hz range with wavelengths in the range of about 0.6 to 4.5 feet. As discussed later, noise barriers are less effective at lower frequencies and more effective at higher ones.

**Table 2-6.** Standardized Band Numbers, Center Frequencies, One-Third-Octave and Octave Bands, and Octave Band Ranges

Band	Center Frequency (Hz)	One-Third-Octave Band Range (Hz)	Octave Band Range (Hz)
<b>12</b>	<b>16</b>	14.1–17.8	<b>11.2–22.4</b>
13	20	17.8–22.4	
14	25	22.4–28.2	
<b>15</b>	<b>31.5</b>	28.2–35.5	<b>22.4–44.7</b>
16	40	35.5–44.7	
17	50	44.7–56.2	
<b>18</b>	<b>63</b>	56.2–70.8	<b>44.7–89.1</b>
19	80	70.8–89.1	
20	100	89.1–112	
<b>21</b>	<b>125</b>	112–141	<b>89.1–178</b>
22	160	141–178	
23	200	178–224	
<b>24</b>	<b>250</b>	224–282	<b>178–355</b>
25	315	282–355	
26	400	355–447	
<b>27</b>	<b>500</b>	447–562	<b>355–708</b>
28	630	562–708	
29	800	708–891	
<b>30</b>	<b>1,000</b>	891–1,120	<b>708–1,410</b>
31	1,250	1,120–1,410	
32	1,600	1,410–1,780	
<b>33</b>	<b>2,000</b>	1,780–2,240	<b>1,410–2,820</b>
34	2,500	2,240–2,820	
35	3,150	2,820–3,550	
<b>36</b>	<b>4,000</b>	3,550–4,470	<b>2,820–5,620</b>
37	5,000	4,470–5,620	
38	6,300	5,620–7,080	
<b>39</b>	<b>8,000</b>	7,080–8,910	<b>5,620–11,200</b>
40	10,000	8,910–11,200	
41	12,500	11,200–14,100	
<b>42</b>	<b>16,000</b>	14,100–17,800	<b>11,200–22,400</b>



Band	Center Frequency (Hz)	One-Third-Octave Band Range (Hz)	Octave Band Range (Hz)
43	20,000	17,800–22,400	

Source: Harris 1979.

Figure 2-5 shows a conventional graphical representation of a typical octave-band frequency spectrum. The octave bands are depicted as having the same width, although each successive band should increase by a factor of 2 when expressed linearly in terms of 1-Hz increments.

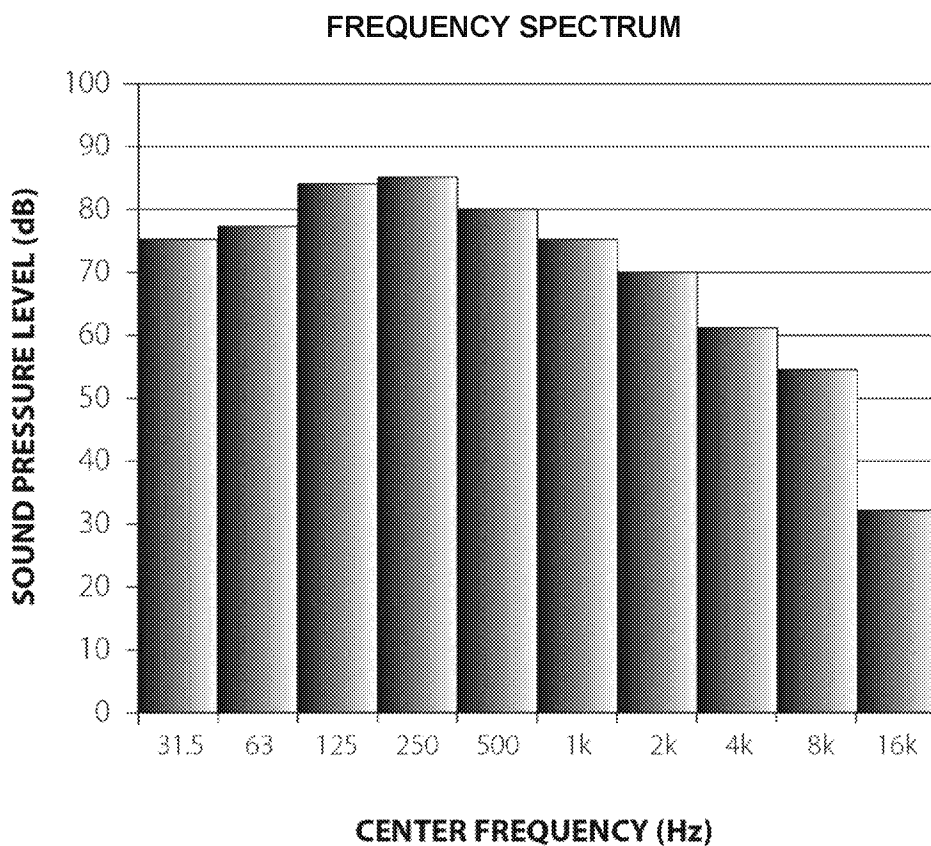

**Figure 2-5.** Typical Octave Band Frequency Spectrum

A frequency spectrum can also be presented in tabular form. For example, the data used to generate Figure 2-5 is illustrated in tabular form in Table 2-7.

**Table 2-7.** Tabular Form of Octave Band Spectrum

Octave Band Center Frequency (Hz)	Sound Pressure Level (dB)
31.5	75
63	77
125	84
250	85
500	80
1,000	75
2,000	70
4,000	61
8,000	54
16,000	32
<b>Total sound pressure level = 89 dB</b>	

Often, one is interested in the total noise level, or the summation of all octave bands. Using the data shown in Table 2-8, one may simply add all the SPLs, as was explained in Section 2.1.3.5. The total noise level for the above octave band frequency spectrum is 89 dB.

The same sorts of charts and tables can be compiled from one-third-octave band information. For example, if more detailed one-third-octave information for the above spectrum is available, a one-third-octave band spectrum could be constructed as shown in Figure 2-6 and Table 2-8. Note that the total noise level does not change, and that each subdivision of three one-third-octave bands adds up to the total octave band shown in the previous example.

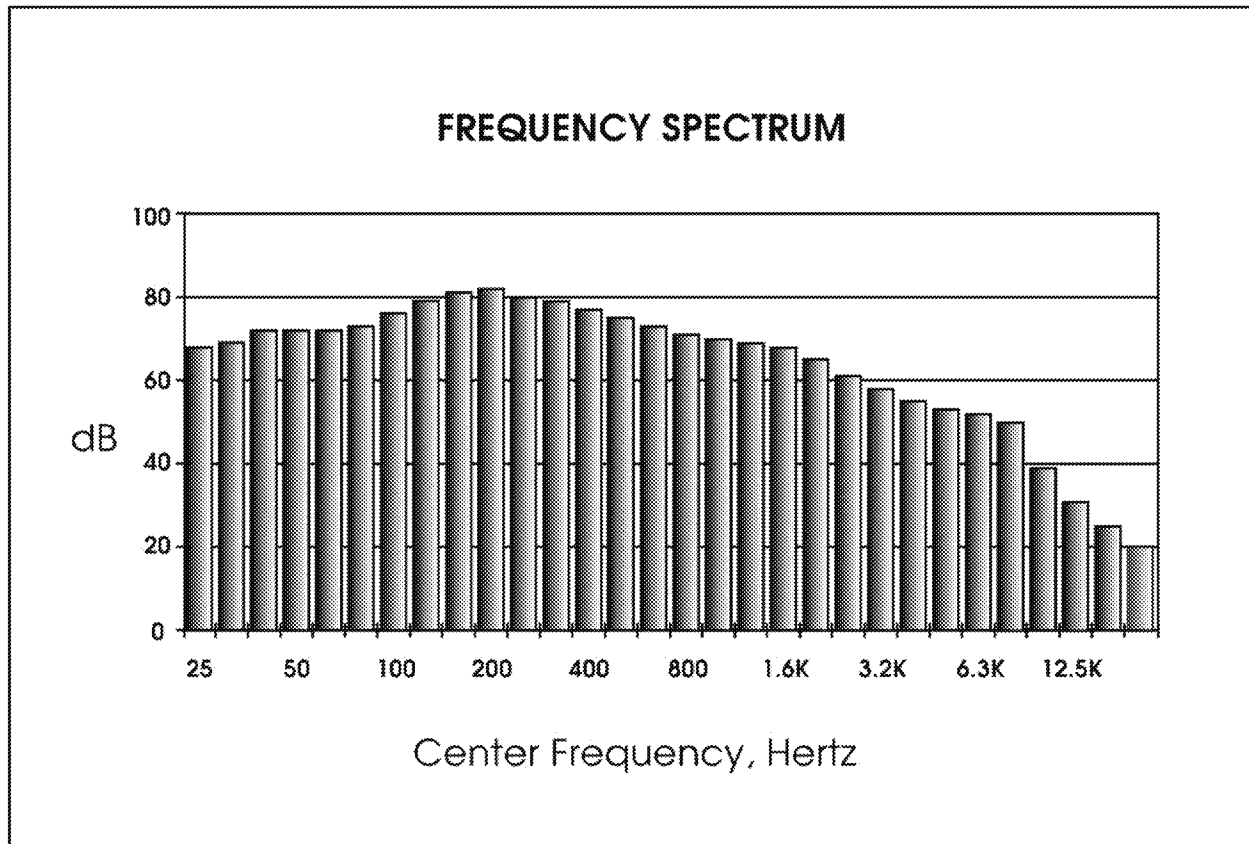

**Figure 2-6.** Typical One-Third-Octave Band Frequency Spectrum

Frequency spectrums are usually expressed in linear, unweighted SPLs (dB). However, they may also be A-weighted by applying the adjustments from Table 2-4. For example, the data in Table 2-8 can be A-weighted (rounded to nearest dB) as shown in Table 2-9.

**Table 2-8.** Tabular Form of One-Third Octave Band Spectrum

One-Third-Octave Band Center Frequency (Hz)	Sound Pressure Level (dB)	One-Third-Octave Band Center Frequency (Hz)	Sound Pressure Level (dB)	One-Third-Octave Band Center Frequency (Hz)	Sound Pressure Level (dB)
25	68	<b>250</b>	80	2,500	61
<b>31.5</b>	69	315	79	3,200	58
40	72	400	77	<b>4,000</b>	55
50	72	<b>500</b>	75	5,000	53
<b>63</b>	72	630	73	6,300	52
80	73	800	71	<b>8,000</b>	50
100	76	<b>1,000</b>	70	10,000	39
<b>125</b>	79	1,250	69	12,500	31
160	81	1,600	68	<b>16,000</b>	25

One-Third-Octave Band Center Frequency (Hz)	Sound Pressure Level (dB)	One-Third-Octave Band Center Frequency (Hz)	Sound Pressure Level (dB)	One-Third-Octave Band Center Frequency (Hz)	Sound Pressure Level (dB)
200	82	<b>2,000</b>	65	20,000	20
<b>Total sound pressure level = 89 dB</b>					

**Table 2-9.** Adjusting Linear Octave Band Spectrum to A-Weighted Spectrum

Octave Band Center Frequency (Hz)	Sound Pressure Level (dBA)
31.5	$75 - 39 = 36$
63	$77 - 26 = 51$
125	$84 - 16 = 68$
250	$85 - 9 = 76$
500	$80 - 3 = 77$
1,000	$75 - 0 = 75$
2,000	$70 + 1 = 71$
4,000	$61 + 1 = 62$
8,000	$54 - 1 = 53$
16,000	$32 - 7 = 25$
<b>Total sound pressure level = 89 dB (linear) and 81.5 dBA</b>	

The total A-weighted noise level is 81.5 dBA, compared with the linear noise level of 89 dB. In other words, the original linear frequency spectrum with a total noise level of 89 dB is perceived as a total A-weighted noise level of 81.5 dBA.

A linear noise level of 89 dB with a different frequency spectrum distribution, could have produced a different A-weighted noise level, either higher or lower. The reverse may also be true. Theoretically, an infinite number of frequency spectrums could produce either the same total linear noise level or the same A-weighted spectrum. This is an important concept because it can help explain a variety of phenomena dealing with noise perception. For example, some evidence suggests that changes in frequencies are sometimes perceived as changes in noise levels, although the total A-weighted noise levels do not change significantly. Section 7 addresses with some of these phenomena.

### 2.1.3.8 White and Pink Noise

White noise is noise with a special frequency spectrum that has the same amplitude (level) for each frequency interval over the entire audible frequency spectrum. It is often generated in laboratories for calibrating sound level measuring equipment, specifically its frequency response. One might expect that the octave or one-third-octave band spectrum of white noise would be a straight line, but this is not true. Beginning with the lowest audible octave, each subsequent octave spans twice as many frequencies than the previous ones, and therefore contains twice the energy. This corresponds with a 3-dB step increase for each octave band, and 1 dB for each one-third-octave band.

Pink noise, in contrast, is defined as having the same amplitude for each octave band (or one-third-octave band), rather than for each frequency interval. Its octave or one-third-octave band spectrum is truly a straight “level” line over the entire audible spectrum. Therefore, pink noise generators are conveniently used to calibrate octave or one-third-octave band analyzers.

Both white and pink noise sound somewhat like the static heard from a radio that is not tuned to a particular station.

## 2.1.4 Sound Propagation

From the source to receiver, noise changes both in level and frequency spectrum. The most obvious is the decrease in noise as the distance from the source increases. The manner in which noise reduces with distance depends on the following important factors.

- Geometric spreading from point and line sources.
- Ground absorption.
- Atmospheric effects and refraction.
- Shielding by natural and manmade features, noise barriers, diffraction, and reflection.

### 2.1.4.1 Geometric Spreading from Point and Line Sources

Sound from a small localized source (approximating a point source) radiates uniformly outward as it travels away from the source in a spherical pattern. The sound level attenuates or drops off at a rate of

6 dBA for each doubling of the distance (6 dBA/DD). This decrease, resulting from the geometric spreading of the energy over an ever-increasing area, is referred to as the inverse square law. Doubling the distance increases each unit area, represented by squares with sides “a” in Figure 2-7, from  $a^2$  to  $4a^2$ .

Because the same amount of energy passes through both squares, the energy per unit area at  $2D$  is reduced four times from that at distance  $D$ . Therefore, for a point source the energy per unit area is inversely proportional to the square of the distance. Taking  $10\log_{10}(1/4)$  results in a 6-dBA/DD reduction. This is the point source attenuation rate for geometric spreading.

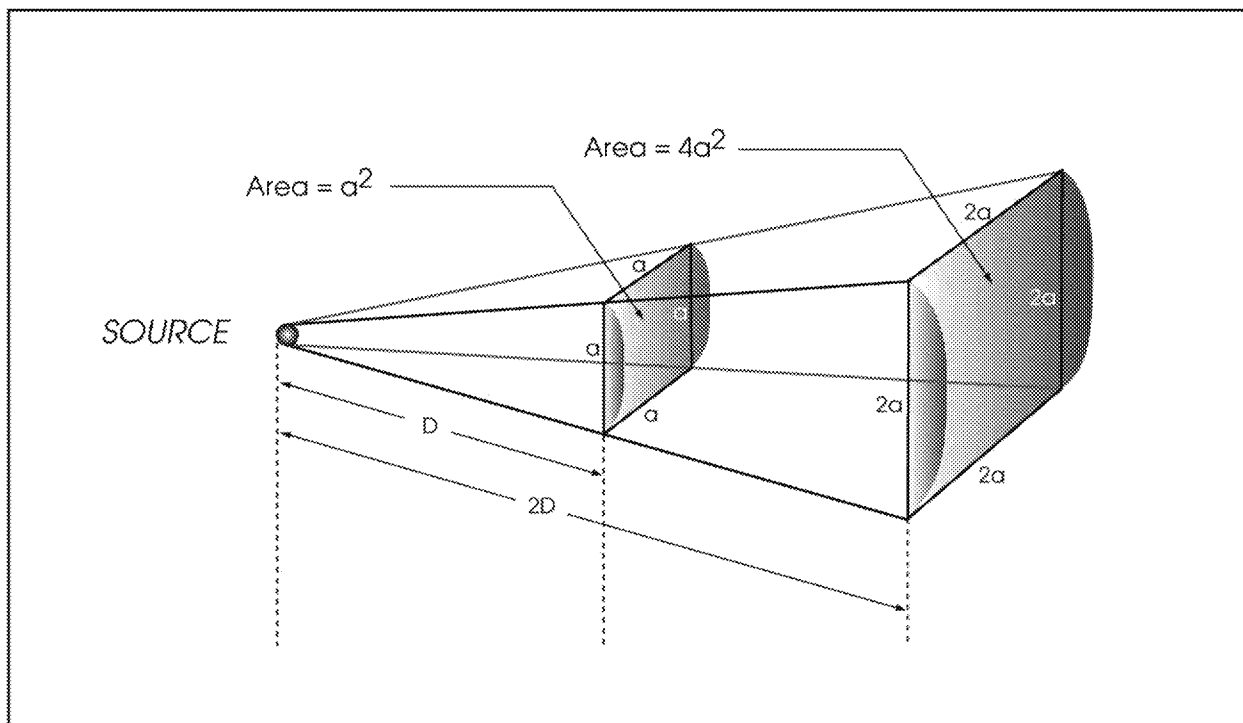

**Figure 2-7.** Point Source Propagation (Spherical Spreading)

As seen in Figure 2-8, based on the inverse square law the change in noise level between any two distances because of spherical spreading can be found using the following equation:

$$dBA_2 = dBA_1 + 10\log_{10}[(D_1/D_2)]^2 = dBA_1 + 20\log_{10}(D_1/D_2) \quad (2-13)$$

Where:

$dBA_1$  = noise level at distance  $D_1$

$dBA_2$  = noise level at distance  $D_2$

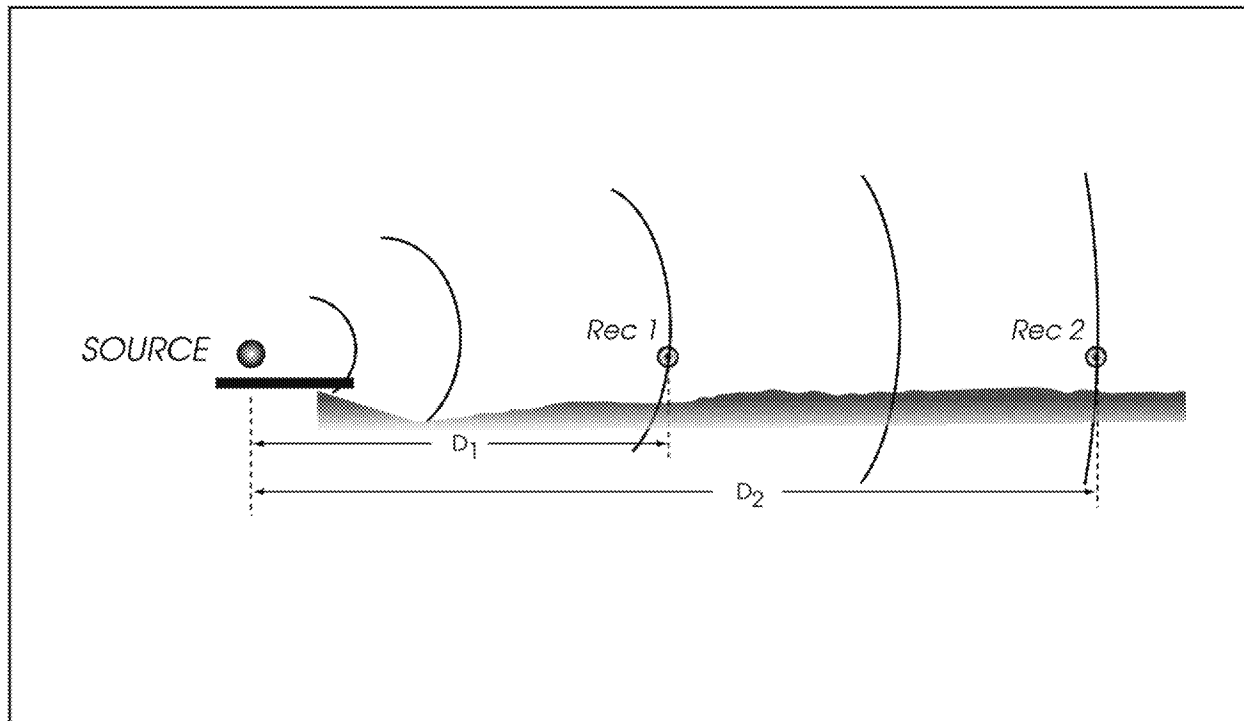

**Figure 2-8.** Change in Noise Level with Distance from Spherical Spreading

However, highway traffic noise is not a single, stationary point source. The movement of the vehicles makes the source of the sound appear to emanate from a line (line source) rather than a point when viewed over a time interval (Figure 2-9). This results in cylindrical spreading rather than spherical spreading. Because the change in surface area of a cylinder only increases by two times for each doubling of the radius instead of the four times associated with spheres, the change in sound level is 3 dBA/DD. The change in noise levels for a line source at any two different distances from cylindrical spreading is determined using the following equation:

$$dBA_2 = dBA_1 + 10\log_{10} (D_1/D_2) \quad (2-14)$$

Where:

$dBA_1$  = noise level at distance  $D_1$  and conventionally the known noise level

$dBA_2$  = noise level at distance  $D_2$  and conventionally the unknown noise level

Note

The expression  $10\log_{10}(D_1/D_2)$  is negative when  $D_2$  is more than  $D_1$  and positive when  $D_1$  is more than  $D_2$ . Therefore, the equation automatically accounts for the receiver being farther or closer with respect to the source— $\log_{10}$  of a number less than 1 gives a negative result,  $\log_{10}$  of a number more than 1 is positive, and  $\log_{10}(1) = 0$ .

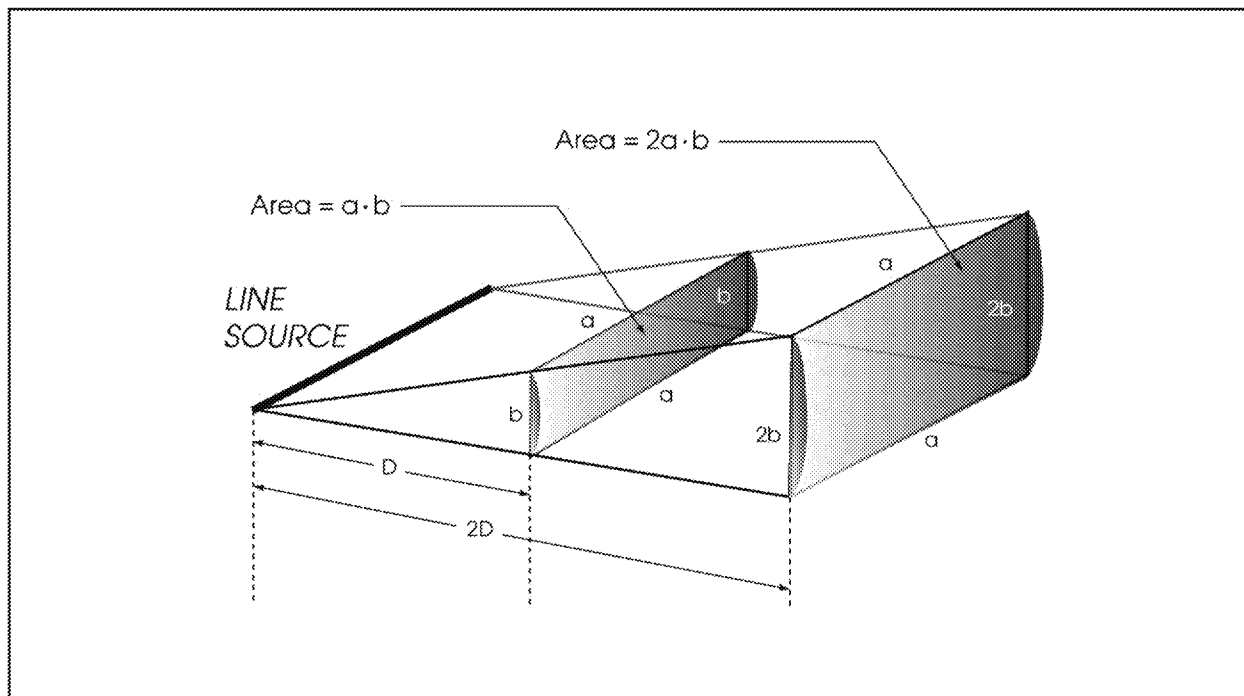

Figure 2-9. Line Source Propagation (Cylindrical Spreading)

### 2.1.4.2 Ground Absorption

Most often, the noise path between the highway and observer is very close to the ground. Noise attenuation from ground absorption and reflective wave cancellation adds to the attenuation from geometric spreading. Traditionally, this excess attenuation has been expressed in terms of decibels of attenuation per doubling of distance. This approximation is done for simplification only; for distances of less than 200 feet, the prediction results based on this scheme are sufficiently accurate. The sum of the geometric spreading attenuation and excess ground attenuation (if any) is referred to as the attenuation or dropoff rate. For distances of 200 feet or more, the approximation causes excessive inaccuracies in predictions. The amount of excess ground attenuation depends on the height of the noise path and characteristics of the intervening ground or site. In practice, excess ground attenuation may vary from 0 to 8–10 dBA/DD or more. In fact, it varies as the noise path height changes from the source to receiver and with vehicle type because the source heights are different. The complexity of terrain also influences the propagation of sound by potentially increasing the number of ground reflections.

The FHWA TNM is the model that is currently approved by FHWA for use in noise impact studies. The TNM has complex algorithms that directly calculate excess ground attenuation based on ground type and site geometry.



### 2.1.4.3 Atmospheric Effects and Refraction

Research by Caltrans and others has shown that atmospheric conditions can have a profound effect on noise levels within 200 feet of a highway. Wind has shown to be the most important meteorological factor within approximately 500 feet, while vertical air temperature gradients are more important over longer distances. Other factors such as air temperature, humidity, and turbulence also have significant effects.

#### Wind

The effects of wind on noise are mostly confined to noise paths close to the ground because of the wind shear phenomenon. Wind shear is caused by the slowing of wind in the vicinity of a ground plane because of surface friction. As the surface roughness of the ground increases, so does the friction between the ground and the air moving over it. As the wind slows with decreasing heights, it creates a sound velocity gradient (because of differential movement of the medium) with respect to the ground. This velocity gradient tends to bend sound waves downward in the same direction of the wind and upward in the opposite direction. The process, called refraction, creates a noise shadow (reduction) upwind of the source and a noise concentration (increase) downwind of the source. Figure 2-10 shows the effects of wind on noise. Wind effects on noise levels along a highway depend very much on wind angle, receiver distance, and site characteristics. A 6-mph cross wind can increase noise levels at 250 feet by about 3 dBA downwind and reduce noise by about the same amount upwind. Present policies and standards ignore the effects of wind on noise levels. Unless wind conditions are specifically identified, noise levels are always assumed to be for zero wind. Noise analyses are also always made for zero-wind conditions.

Wind also has another effect on noise measurements. Wind “rumble” caused by air movement over a microphone of a sound level meter can contaminate noise measurements even if a wind screen is placed over the microphone.

Limited measurements performed by Caltrans in 1987 showed that wind speeds of about 11 mph produce noise levels of about 45 dBA, using a ½-inch microphone with a wind screen. This means that noise measurements below 55 dBA are contaminated by wind speeds of 11 mph or more. A noise level of 55 dBA is about at the low end of the range of noise levels routinely measured near highways for noise analysis. FHWA’s *Measurement of Highway-Related Noise* (1996) recommends that highway noise measurements should not be made at wind speeds above 12 mph. An 11 mph criterion for maximum allowable wind speed for routine highway

noise measurements seems reasonable and is therefore recommended. More information concerning wind/microphone contamination is provided in Section 3.

## Wind Turbulence

Turbulence also has a scattering effect on noise levels, which is difficult to predict. It appears, however, that turbulence has the greatest effect on noise levels in the vicinity of the source.

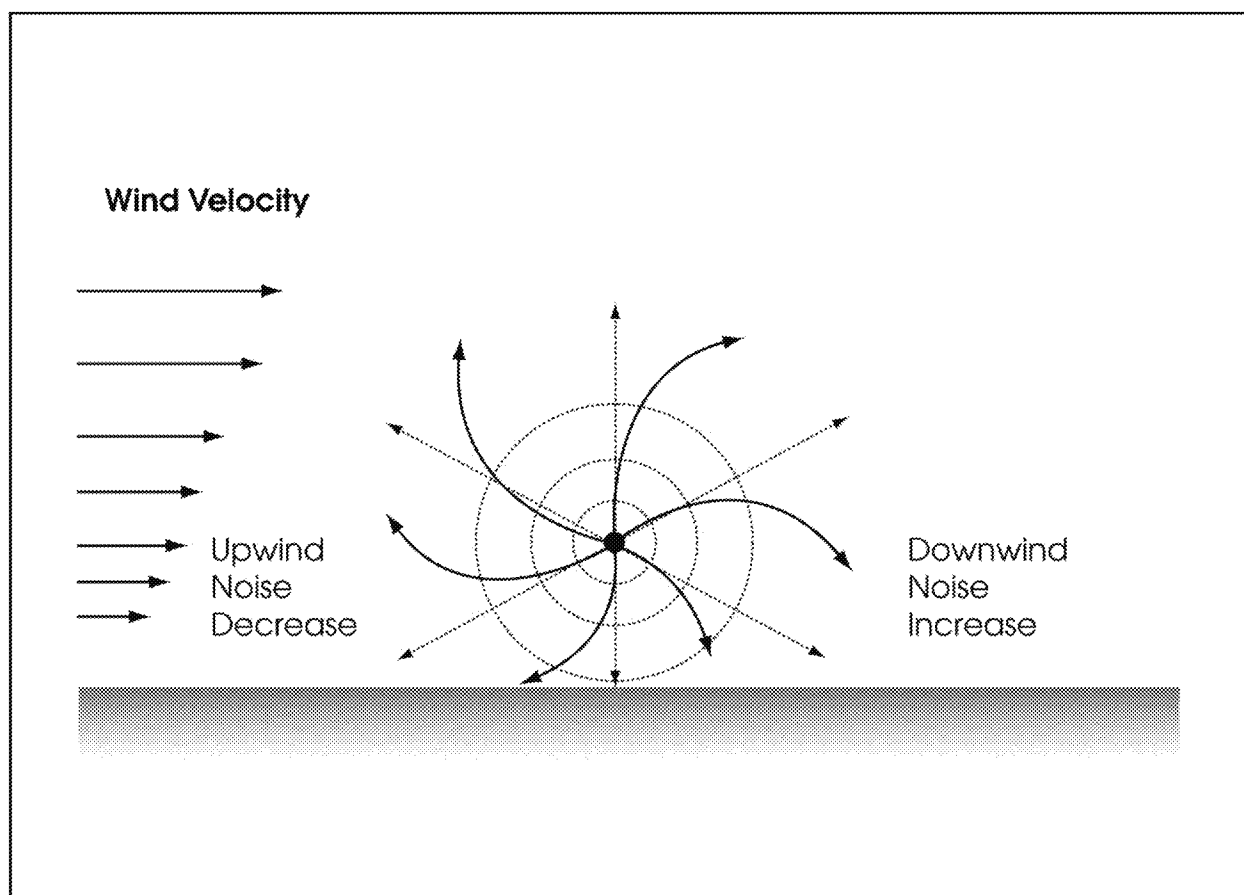

Figure 2-10. Wind Effects on Noise Levels

## Temperature Gradients

Figure 2-11 shows the effects of temperature gradients on noise levels. Normally, air temperature decreases with height above the ground. This is called the normal lapse rate, which for dry air is about  $-5.5^{\circ}\text{F}$  per 1,000 feet. Because the speed of sound decreases as air temperature decreases, the resulting temperature gradient creates a sound velocity gradient with height. Slower speeds of sound higher above the ground tend to refract

sound waves upward in the same manner as wind shear upwind from the source. The result is a decrease in noise. Under certain stable atmospheric conditions temperature profiles can become inverted (i.e., temperatures increase with height either from the ground up or at some altitude above the ground). This inversion results in speeds of sound that temporarily increase with altitude, causing noise refraction similar to that caused by wind shear downwind from a noise source. Also, once trapped within an elevated inversion layer, noise may be carried over long distances. Both ground and elevated temperature inversions have the effect of propagating noise with less than the usual attenuation rates and therefore increase noise. The effects of vertical temperature gradients are more important over longer distances.

## Temperature and Humidity

Molecular absorption in air also reduces noise levels with distance. Although this process only accounts for about 1 dBA per 1,000 feet under average conditions of traffic noise in California, the process can cause significant longer-range effects. Air temperature and humidity affect molecular absorption differently depending on the frequency spectrum and can vary significantly over long distances in a complex manner.

## Rain

Wet pavement results in an increase in tire noise and corresponding increase in frequencies of noise at the source. Wet pavement may increase vehicle noise emission levels relative to dry conditions in the range of 0 to 15 dBA (Sandberg and Ejsmont 2002). Because the propagation of noise is frequency-dependent, rain may also affect distance attenuation rates. However, traffic generally slows down during rain, decreasing noise levels and lowering frequencies. When wet, pavement types interact differently with tires than when they are dry. These factors make it very difficult to predict noise levels during rain. Therefore, no noise measurements or predictions should be made under rainy conditions. Noise abatement criteria (NAC) and standards in the FHWA noise regulation (23 CFR 772) are based on completely dry pavement.

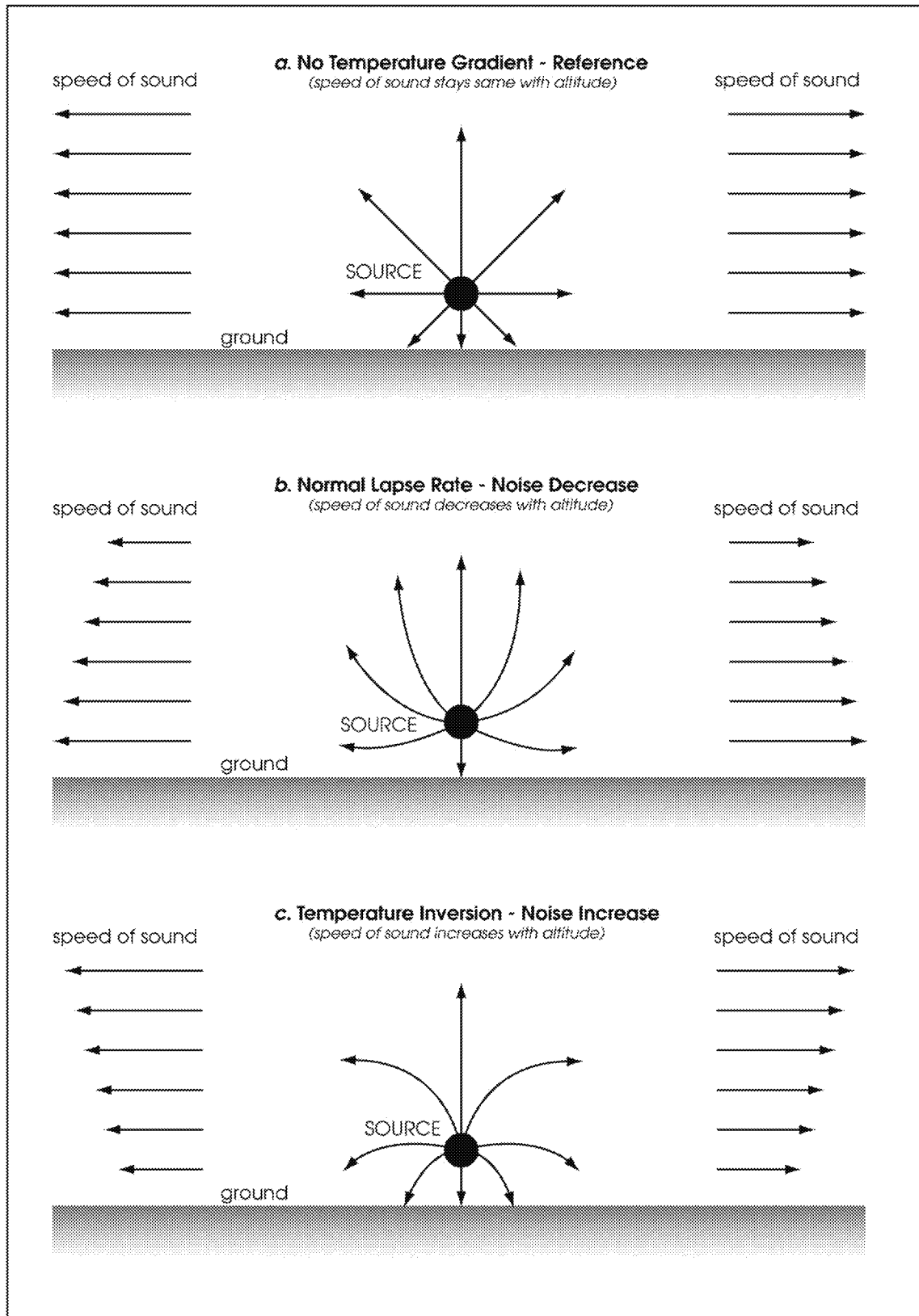

Figure 2-11. Effects of Temperature Gradients on Noise

#### **2.1.4.4 Shielding by Natural and Manmade Features, Noise Barriers, Diffraction, and Reflection**

A large object in the path between a noise source and receiver can significantly attenuate noise levels at the receiver. The amount of attenuation provided by this shielding depends on the size of the object and frequencies of the noise levels. Natural terrain features such as hills and manmade features, such as buildings and walls, can significantly alter noise levels. Walls are often used specifically to reduce noise.

##### **Trees and Vegetation**

It is uncommon for trees and vegetation to result in a noticeable reduction in noise. A vegetative strip must be very dense and wide for there to be any meaningful shielding effect. A heavily vegetated ground surface may increase ground absorption which can increase attenuation over distance.

##### **Landscaping**

Caltrans research (California Department of Transportation 1995) has shown that ordinary landscaping along a highway accounts for less than 1 dBA of reduction. Claims of increases in noise from removal of vegetation along highways are mostly spurred by the sudden visibility of the traffic source. There is evidence of a psychological effect (“out of sight, out of mind”) of vegetation on noise.

##### **Buildings**

Depending on site geometry, the first row of houses or buildings next to a highway may shield the successive rows. This often occurs where the facility is at-grade or depressed. The amount of noise reduction varies with building sizes, spacing of buildings, and site geometry. Generally, for an at-grade facility in an average residential area where the first row houses cover at least 40% of total area (i.e., no more than 60% spacing), the reduction provided by the first row is reasonably assumed to be 3 dBA, with 1.5 dBA for each additional row. For example, one may expect a 3-dBA noise reduction behind the first row, 4.5 dBA behind the second row, and 6 dBA behind the third row. For houses or buildings spaced tightly (covering about 65% to 90% of the area, with 10% to 35% open space), the first row provides about 5 dBA of reduction. Successive rows still reduce noise by 1.5 dBA per row. However, for the reason discussed in the preceding discussion, the limit is 10 dBA. For these assumptions to be true

the first row of houses or buildings must be equal to or higher than the second row, which should be equal to or higher than the third row, etc.

## Noise Barriers

Although any natural or manmade feature between source and receiver that reduces noise is technically a noise barrier, the term is generally reserved for a wall or berm specifically constructed for noise reduction. The acoustical design of noise barriers is addressed in Section 5. However, it is appropriate at this time to introduce the acoustical concepts associated with noise barriers. These principles apply loosely to any obstacle between the source and receiver.

As shown in Figure 2-12, when a noise barrier is inserted between a noise source and receiver, the direct noise path along the line of sight between the two is interrupted. Some of the acoustical energy will be transmitted through the barrier material and continue to the source, although at a reduced level. The amount of this reduction depends on the material's mass and rigidity, and is called the transmission loss (TL), which is expressed in decibels. Its mathematical expression is:

$$TL = 10\log_{10}(E_f/E_b) \quad (2-15)$$

Where:

$E_f$  = relative noise energy immediately in front of barrier (source side)

$E_b$  = relative noise energy immediately behind barrier (receiver side)

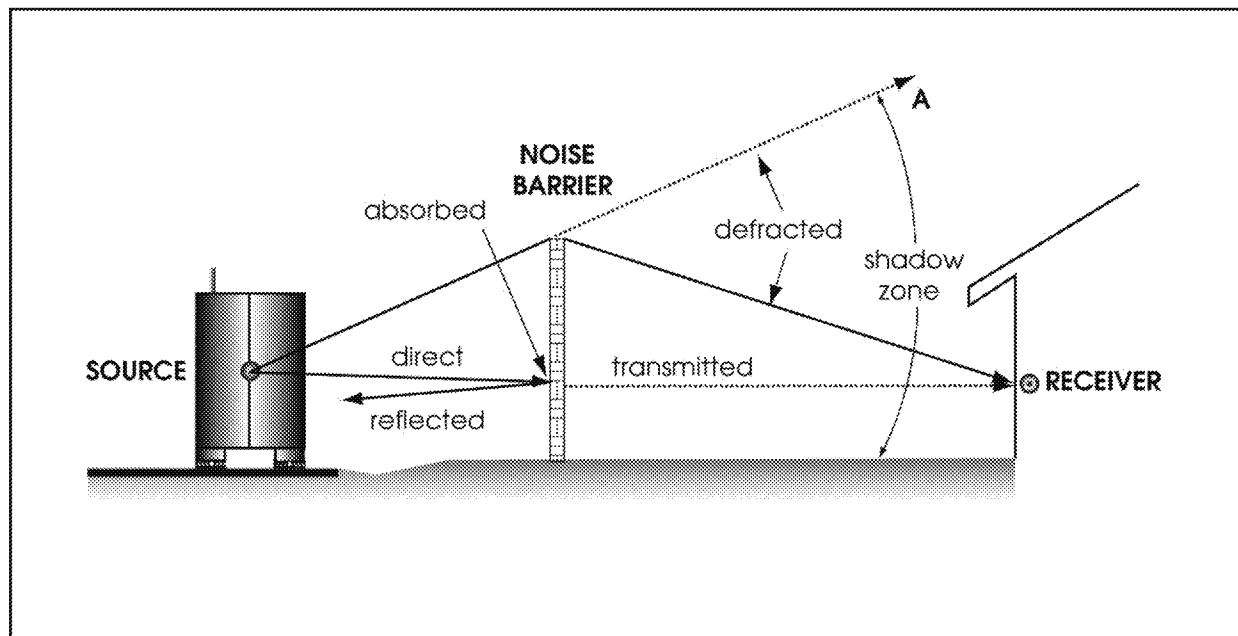

**Figure 2-12.** Alteration of Sound Paths after Inserting a Noise Barrier between Source and Receiver

Please note that  $E_f$  and  $E_b$  are relative energies (i.e., energies with reference to the energy of 0 dB [Section 2.1.3.4]). As relative energies, they may be expressed as any ratio (fractional or percentage) that represents their relationship. For example, if 1% of the noise energy striking a barrier is transmitted,  $TL = 10\log_{10}(100/1) = 20$  dBA. Most noise barriers have TLs of 30 dBA or more. This means that only 0.1% of the noise energy is transmitted.

The remaining direct noise (usually close to 100%) is either partially or entirely absorbed by the noise barrier material (if sound absorptive) and/or partially or entirely reflected by it (if sound reflective). Whether the barrier is reflective or absorptive depends on its ability to absorb sound energy. A smooth, hard barrier surface, such as masonry or concrete, is considered almost perfectly reflective (i.e., almost all sound striking the barrier is reflected back toward the source and beyond). A barrier surface material that is porous, with many voids, is said to be absorptive (i.e., little or no sound is reflected back). The amount of energy absorbed by a barrier surface material is expressed as an absorption coefficient  $\alpha$ , which has a value ranging from 0 (100% reflective) to 1 (100% absorptive). A perfect reflective barrier ( $\alpha = 0$ ) will reflect back virtually all noise energy (assuming a transmission loss of 30 dBA or more) toward the opposite side of a highway. If the difference in path length between the direct and reflected noise paths to the opposite (unprotected) side of a highway is ignored, the maximum expected increase in noise will be 3 dBA.

If one wishes to calculate the noise increase from a partially absorptive wall, Equation 2-15 may be used.  $E_r$  is the noise energy striking the barrier, but  $E_b$  becomes the energy reflected back. For example, a barrier material with an  $\alpha$  of 0.6 absorbs 60% of the direct noise energy and reflects back 40%. To calculate the increase in noise on the opposite side of the highway in this situation, the energy loss from the transformation of the total noise striking the barrier to the reflected noise energy component is  $10 \log_{10}(100/40) = 4$  dBA. In other words, the energy loss of the reflection is 4 dBA. If the direct noise level of the source at a receiver on the opposite side of the highway is 65 dBA, the reflective component (ignoring the difference in distances traveled) will be 61 dBA. The total noise level at the receiver is the sum of 65 and 61 dBA, slightly less than 66.5 dBA. The reflected noise caused an increase of 1.5 dBA at the receiver.

The transmitted, absorbed, and reflected noise paths shown in Figure 2-12 are variations of the direct noise path. Of these three paths, only transmitted noise reaches the receiver behind the barrier. However, there is one more path—the diffracted path—that reaches the receiver. The diffracted path is actually the most important path. With the barrier in place, sound energy traveling along this path is diffracted downward toward the receiver.

In general, diffraction is characteristic of all wave phenomena, including light, water, and sound waves. It can best be described as the bending of waves around objects. The amount of diffraction depends on the wavelength and size of the object. Low frequency waves with long wavelengths approaching the size of the object are easily diffracted. Higher frequencies with short wavelengths in relation to the size of the object are not as easily diffracted. This explains why light, with its very short wavelengths, casts shadows with fairly sharp, well defined edges between light and dark. Sound waves also “cast a shadow” when they strike an object. However, because of their much longer wavelengths (by at least about six orders of magnitude) the noise shadows are not very well defined and amount to a noise reduction, not an absence of noise.

Because noise consists of many different frequencies that diffract by different amounts, it seems reasonable to expect that the greater the angle of diffraction, the more frequencies will be attenuated. In Figure 2-12, beginning with the top of the shadow zone and going down to the ground surface, the higher frequencies will be attenuated first, then the middle frequencies, and finally the lower ones. Please notice that the top of the shadow zone is defined by the extension of a straight line from the noise source (in this case represented at the noise centroid as a point source) to the top of the barrier. The diffraction angle is defined by the top of the shadow zone and the line from the top of the barrier to receiver. Therefore,



the position of the source relative to the top of the barrier determines the extent of the shadow zone and the diffraction angle to the receiver. Similarly, the receiver location relative to the top of the barrier is also important in determining the diffraction angle.

From the previous discussion, three conclusions are clear. First, the diffraction phenomenon depends on three critical locations: source, top of barrier, and receiver. Second, for a given source, top of barrier, and receiver configuration, a barrier is more effective in attenuating higher frequencies than lower frequencies (Figure 2-13). Third, the greater the angle of diffraction, the greater the noise attenuation.

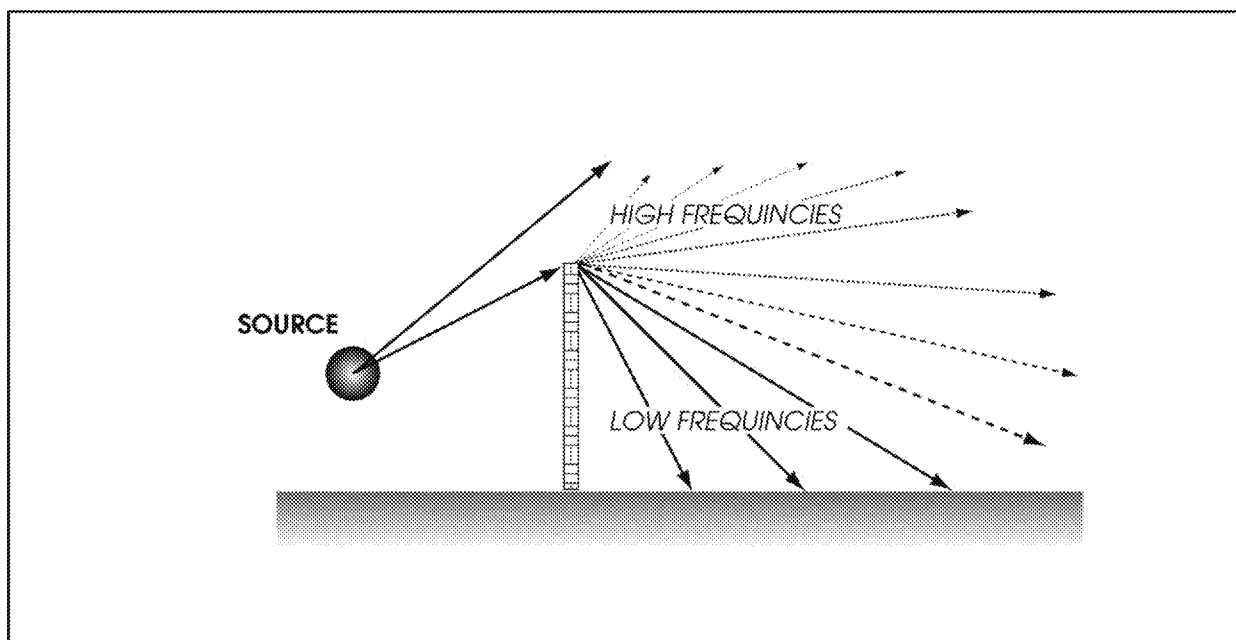

**Figure 2-13.** Diffraction of Sound Waves

The angle of diffraction is also related to the path length difference ( $\delta$ ) between the direct noise and diffracted noise. Figure 2-14 illustrates the concept of path length difference. A closer examination of this illustration reveals that as the diffraction angle becomes greater, so does  $\delta$ . The path length difference is defined as  $\delta = a + b - c$ . If the horizontal distances from the source to receiver and the source to barrier, as well as the differences in elevation between the source, top of barrier, and receiver, are known,  $a$ ,  $b$ , and  $c$  can readily be calculated. Assuming that the source in Figure 2-14 is a point source,  $a$ ,  $b$ , and  $c$  are calculated as follows:

$$a = \sqrt{[d_1^2 + (h_2 - h_1)^2]}$$

$$b = \sqrt{(d_2^2 + h_2^2)}$$

$$c = \sqrt{(d^2 + h_1^2)}$$

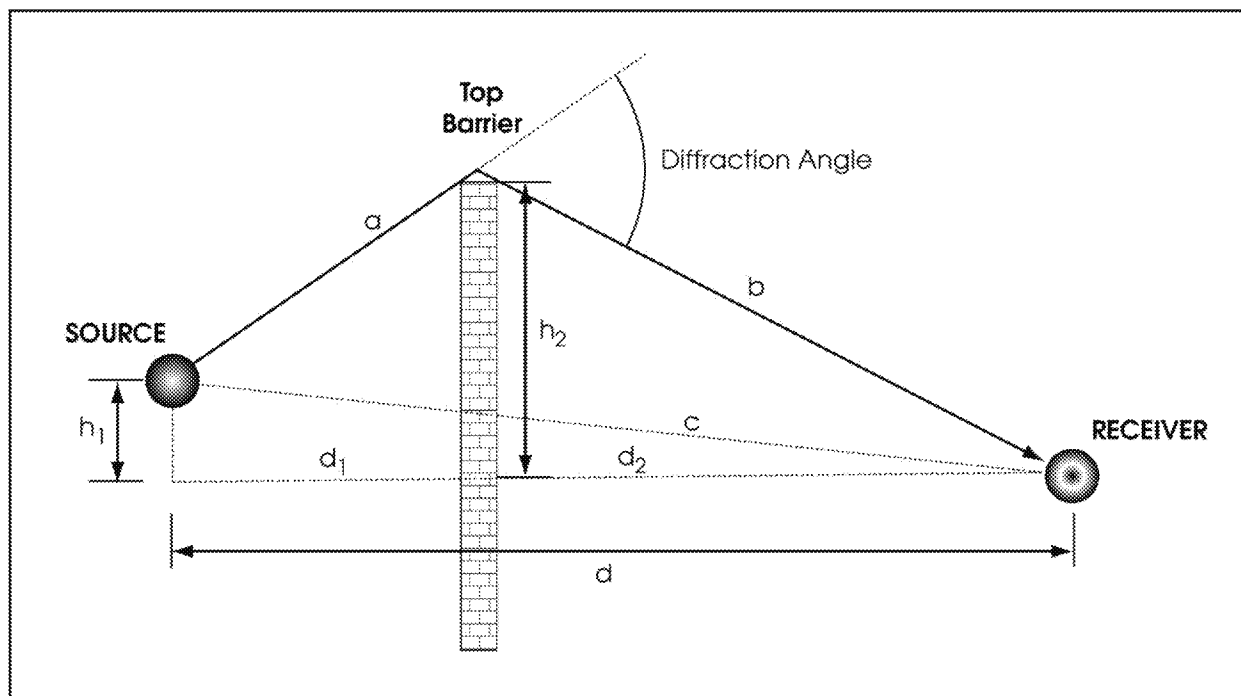

Figure 2-14. Path Length Difference between Direct and Diffracted Noise Paths

Highway noise prediction models use  $\delta$  in barrier attenuation calculations. Section 5 addresses the subject in greater detail. However, it is appropriate to include the most basic relationship between  $\delta$  and barrier attenuation through the Fresnel number ( $N_0$ ). If the source is a line source (e.g., highway traffic) and the barrier is infinitely long, there is an infinite number of path length differences. The path length difference ( $\delta_0$ ) at the perpendicular line to the barrier is then of interest. Mathematically,  $N_0$  is defined as follows:

$$N_0 = 2(\delta_0/\lambda) \quad (2-16)$$

Where:

$N_0$  = Fresnel number determined along the perpendicular line between source and receiver (i.e., barrier must be perpendicular to the direct noise path)

$\delta_0 = \delta$  measured along perpendicular line to barrier

$\lambda$  = wavelength of sound radiated by source

According to Equation 2-3,  $\lambda = c/f$ . Therefore, Equation 2-16 may be rewritten as follows:

$$N_0 = 2(f\delta_0/c) \quad (2-17)$$

Where:

f = frequency of sound radiated by source

c = speed of sound

Please note that these equations relate  $\delta_0$  to  $N_0$ . If one increases, so does the other, along with barrier attenuation. Similarly, if frequency increases, so will  $N_0$  and barrier attenuation. Figure 2-15 shows the barrier attenuation  $\Delta_B$  for an infinitely long barrier as a function of 550 Hz. It has been found that the attenuation of the A-weighted SPL of typical traffic is almost identical to the sound attenuation of 55 Hz frequency band. (Federal Highway Administration 1978)

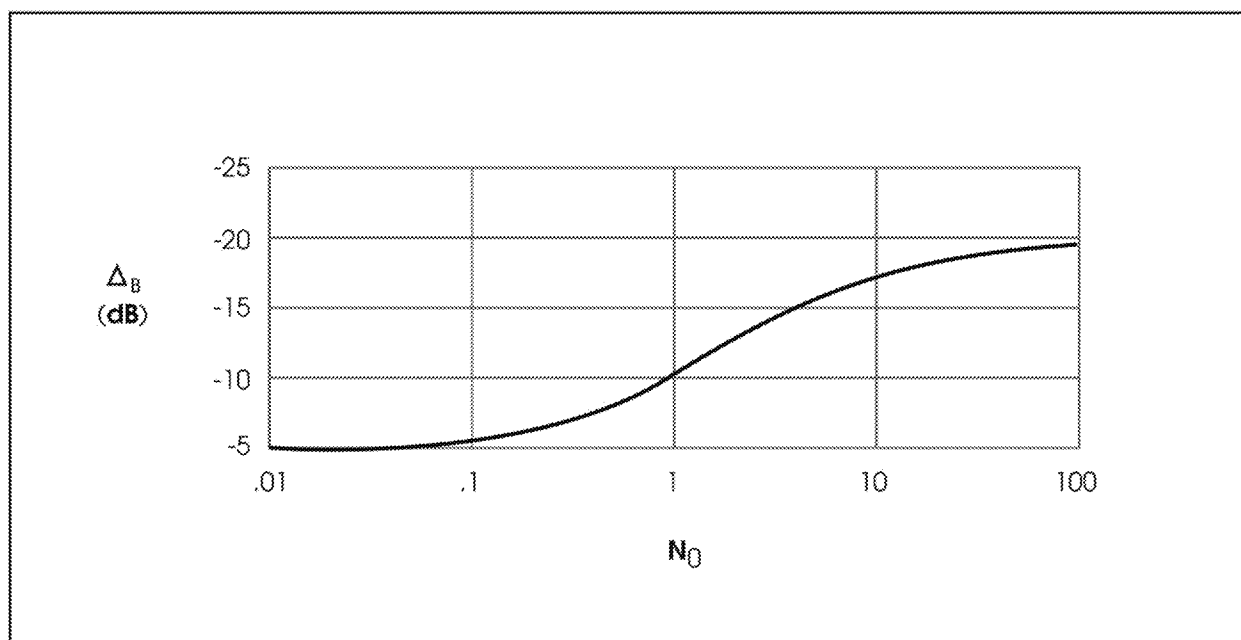

**Figure 2-15.** Barrier Attenuation ( $\Delta_B$ ) vs. Fresnel Number ( $N_0$ ) for Infinitely Long Barriers

A barrier can be effective even when it does not completely block the line of sight between the source and the receiver. Figure 2-16 illustrates a special situation where the top of the barrier is just high enough to graze the direct noise path, or line of sight between the source and receiver. In this situation, a noise barrier provides about 5 dBA of attenuation.

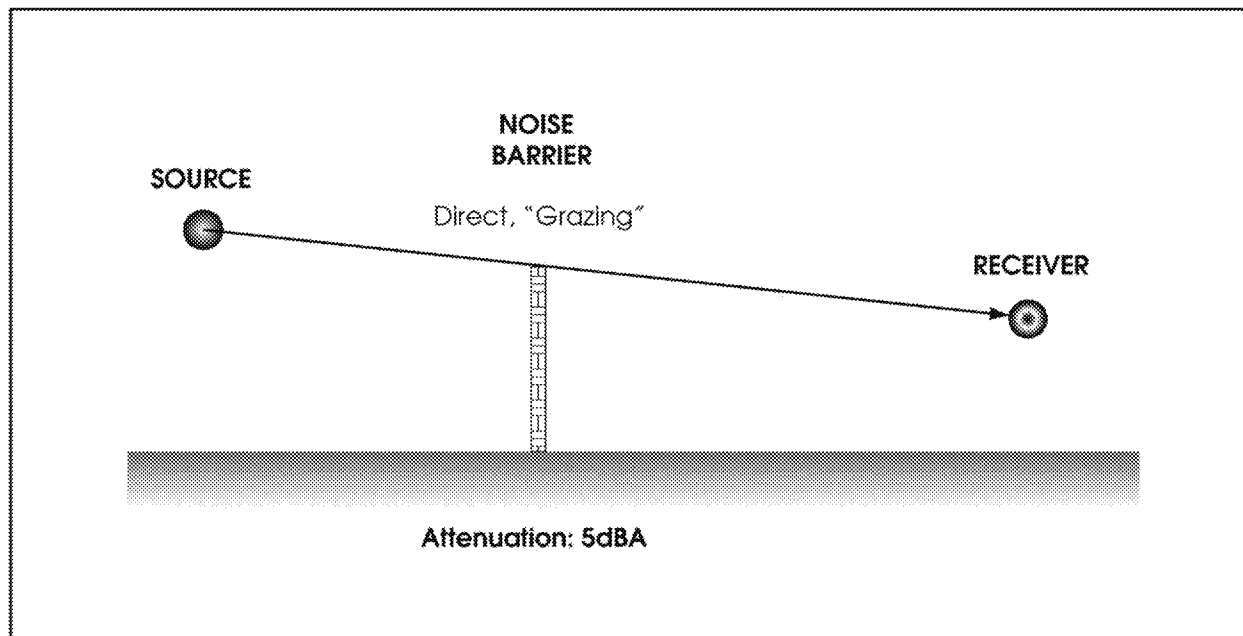

**Figure 2-16.** Direct Noise Path Grazing Top of Barrier, Resulting in 5 dBA of Attenuation

Another situation, in which the direct noise path is not interrupted but still close to the barrier, will provide some noise attenuation (Figure 2-17). Such negative diffraction (with an associated negative path length difference and Fresnel number) generally occurs when the direct noise path is within 5 feet above the top of the barrier for the average traffic source and receiver distances encountered in near-highway noise environments. The noise attenuation provided by this situation is between 0 and 5 dBA—5 dBA when the noise path approaches the grazing point, and near 0 dBA when it clears the top of the barrier by approximately 5 feet or more.

These principles of barriers apply loosely to terrain features (e.g., berms, low ridges, other significant manmade features). The principles are discussed in more detail in Section 5.

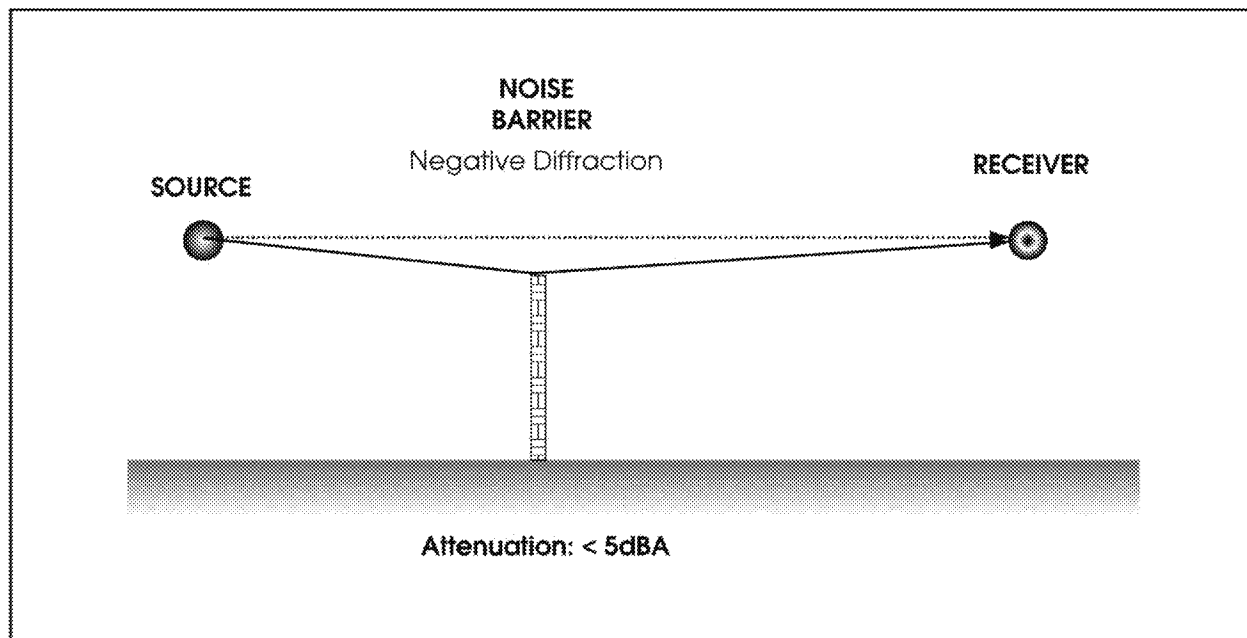

Figure 2-17. Negative Diffraction, Which Provides Some Noise Attenuation

## 2.2 Effects of Noise and Noise Descriptors

### 2.2.1 Human Reaction to Sound

People react to sound in a variety of ways. For example, rock music may be pleasant to some people, while for others it may be annoying, constitute a health hazard, or disrupt activities. Human tolerance to noise depends on a variety of acoustical characteristics of the source and environmental characteristics. These factors are briefly discussed below.

- **Noise Level, Variability in Level (Dynamic Range), Duration, Frequency Spectrums, and Time Patterns:** Exposures to very high noise levels can damage hearing. A high level is more objectionable than a low-level noise. For example, intermittent truck peak noise levels are more objectionable than the continuous level of fan noise. Humans have better hearing sensitivities in the high frequency region than the low. This is reflected in the A-scale (Section 2.1.3.6), which deemphasizes the low-frequency sounds. Studies indicate that annoyance or disturbance correlates with the A-scale.
- **Amount of Background Noise Present before Intruding Noise:** People tend to compare an intruding noise with existing background noise. If the new noise is readily identifiable or considerably louder

than the background or ambient, it usually becomes objectionable. One example is an aircraft flying over a residential area.

- **Nature of Work or Living Activity Exposed to Noise Source:** Highway traffic noise might not be disturbing to workers in a factory or office, but it might be annoying or objectionable to people sleeping at home or studying in a library. An automobile horn at 2:00 a.m. is more disturbing than the same noise in traffic at 5:00 p.m.

### 2.2.1.1 Human Response to Changes in Noise Levels

Under controlled conditions in an acoustics laboratory, the trained healthy human ear is able to discern changes in sound levels of 1 dBA when exposed to steady single-frequency (pure tone) signals in the mid-frequency range. Outside such controlled conditions, the trained ear can detect changes of 2 dBA in normal environmental noise. It is generally accepted that the average healthy ear, however, can barely perceive a noise level change of 3 dBA. If changes to the character (i.e., frequency content) of a sound occur, level changes less than 3 dBA may be noticeable. Individuals who are exposed to continuous traffic noise may also be able to notice small changes in noise levels (i.e., less than 3 dBA).

Earlier, the concept of A-weighting and the reasons for describing noise in terms of dBA were discussed. The human response curve of frequencies in the audible range is simply not linear (i.e., humans do not hear all frequencies equally well).

It appears that the human perception of loudness is also not linear, either in terms of decibels or in terms of acoustical energy. As discussed, there is a mathematical relationship between decibels and relative energy. For example, if one source produces a noise level of 70 dBA, two of the same sources produce 73 dBA, three will produce about 75 dBA, and 10 will produce 80 dBA.

Human perception is complicated by the fact that it has no simple correlation with acoustical energy. Two noise sources do not sound twice as loud as one noise source. Based on studies conducted over the years some approximate relationships between changes in acoustical energy and corresponding human reaction have been charted. Table 2-10 shows the relationship between changes in acoustical energy, dBA, and human perception. The table shows the relationship between changes in dBA ( $\Delta$ dBA), relative energy with respect to a reference of a  $\Delta$ dBA of 0 (no change), and average human perception. The factor change in relative energy relates to the change in acoustic energy.

**Table 2-10.** Relationship between Noise Level Change, Factor Change in Relative Energy, and Perceived Change

Noise Level Change, (dBA)	Change in Relative Energy ( $10^{\pm\Delta\text{dBA}/10}$ )	Perceived Change	
		Perceived Change in Percentage ( $[2^{\pm\Delta\text{dBA}/10} - 1] * 100\%$ )	Descriptive Change in Perception
+40	10,000		16 times as loud
+30	1,000		Eight times as loud
+20	100	+300%	Four times as loud
+15	31.6	+183%	
+10	10	+100%	Two times as loud
+9	7.9	+87%	
+8	6.3	+74%	
+7	5.0	+62%	
+6	4.0	+52%	
+5	3.16	+41%	Readily perceptible increase
+4	2.5	+32%	
+3	2.0	+23%	Barely perceptible increase
0	1	0%	Reference (no change)
-3	0.5	-19%	Barely perceptible reduction
-4	0.4	-24%	
-5	0.316	-29%	Readily perceptible reduction
-6	0.25	-34%	
-7	0.20	-38%	
-8	0.16	-43%	
-9	0.13	-46%	
-10	0.10	-50%	One-half as loud
-15	0.0316	-65%	
-20	0.01	-75%	One-quarter as loud
-30	0.001		One-eighth as loud
-40	0.0001		One-sixteenth as loud

Section 2.1.3.3 discusses that the rms value of the sound pressure ratio squared ( $P_1/P_2$ ) is proportional to the energy content of sound waves (acoustic energy). Human perception is displayed in two columns: percentage and descriptive. The percentage of perceived change is based on the mathematical approximation that the factor change of human perception relates to  $\Delta\text{dBA}$  as follows:

$$\text{Factor Change in Perceived Noise Levels} = 2^{\pm\Delta\text{dBA}/10} \quad (2-18)$$

According to this equation, the average human ear perceives a 10-dBA decrease in noise levels as half of the original level ( $2^{\pm\Delta\text{dBA}/10} = 2^{-10/10} = 0.5$ ). By subtracting 1 and multiplying by 100, the result will be in terms of a percentage change in perception, where a positive (+) change represents an increase and a negative (-) change a decrease. The descriptive perception column indicates how the percentage change is typically perceived.

## 2.2.2 Describing Noise

Noise in our daily environment fluctuates over time. Some fluctuations are minor, and some are substantial. Some occur in regular patterns, and others are random. Some noise levels fluctuate rapidly, and others slowly. Some noise levels vary widely, and others are relatively constant. To describe noise levels, one needs to choose the proper noise descriptor or statistic.

### 2.2.2.1 Time Patterns

Figure 2-18 is a graphical representation of how noise can have different time patterns depending on the source. Shown are noise levels vs. time patterns of four different sources: a fan (a), pile driver (b), single vehicle passby (c), and highway traffic (d).

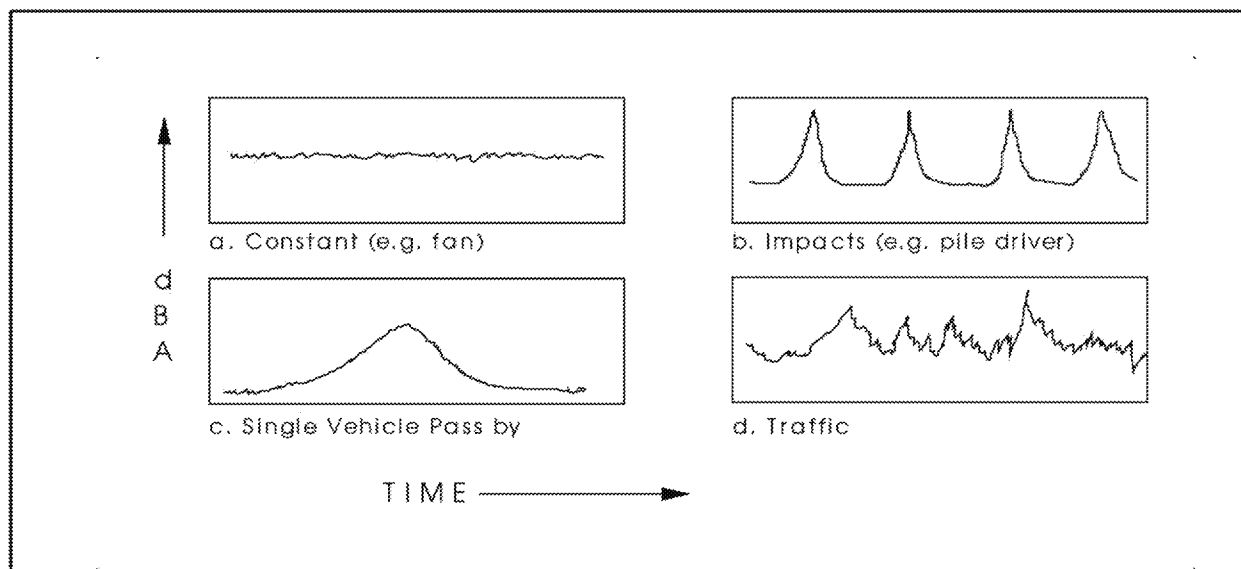

**Figure 2-18.** Different Noise Level vs. Time Patterns

The simplest noise level time pattern is constant noise, which is essentially a straight, level line. Such a pattern is characteristic of stationary fans,



compressors, pumps, and air conditioners. At each instant, the noise level is about the same for a fixed observer. A single measurement taken at random would suffice to describe the noise level at a specific distance. The minimum and maximum noise levels would be nearly the same as the average noise level.

Other noise levels vs. time patterns are more complicated. For example, to describe the pile driving noise, noise samples need to include the instantaneous peaks, or maximum noise levels. In our environment, there are a range of noises of many different patterns in addition to the ones shown in Figure 2-18. The levels may be extremely short in duration, such as a single gunshot (transient noise); intermittent, such as the pile driver; or continuous, such as the fan. Traffic noise along major highways tends to lie somewhere between intermittent and continuous. It is characterized by the somewhat random distribution of vehicles, each of which emits a pattern such as shown for a single vehicle passby.

### 2.2.2.2 Noise Descriptors

The proper noise descriptor to use in any given situation depends on the nature of the noise source. For example a high amplitude short duration event such as gunshot requires a different descriptor than a constant relatively low amplitude noise source such as traffic. The proper descriptor depends on the spatial distribution of noise sources, duration of the noise event, amount of fluctuation, and time patterns.

Dozens of descriptors and scales have been devised over the years to quantify community noise, aircraft flyovers, traffic noise, industrial noise, speech interference, etc. The descriptors shown in Table 2-11 are those encountered most often in traffic, community, and environmental noise. There are many more descriptors not discussed here. The word "Level," abbreviated  $L$ , is frequently used whenever sound is expressed in decibels relative to the reference pressure. Therefore, all the descriptors shown in Table 2-11 have  $L$  as part of the term.

All Caltrans highway traffic noise analysis should be done in terms of worst noise hour  $L_{eq}(h)$  as required under 23 CFR 772. If a noise analysis requires other descriptors to satisfy city or county requirements, see Section 2.2.3 for a discussion of descriptor conversions.

**Table 2-11. Common Noise Descriptors**

Noise Descriptor	Definition
Maximum noise level ( $L_{\max}$ )	The highest instantaneous noise level during a specified time period. This descriptor is sometimes referred to as “peak (noise) level.” The use of term “peak level” should be discouraged because it may be interpreted as a non-rms noise signal (see Section 2.1.3.3 for difference between peak and rms).
Statistical descriptor ( $L_x$ )	The noise level exceeded $X$ % of a specified time period. The value of $X$ is commonly 10 (e.g., $L_{10}$ ). Other values such as 50 and 90 are used also.
Equivalent noise level ( $L_{\text{eq}}$ ). Routinely used by Caltrans and FHWA to address the worst noise hour ( $L_{\text{eq}}[\text{h}]$ ).	The equivalent steady-state noise level in a stated period of time that would contain the same acoustic energy as the time-varying noise level during the same period
Day-night noise level ( $L_{\text{dn}}$ ). Used commonly for describing community noise levels.	A 24-hour $L_{\text{eq}}$ with a “penalty” of 10 dBA added during the night hours (10 p.m. to 7 a.m.) because this time is normally used for sleep
Community noise equivalent level (CNEL). A common community noise descriptor, also used for airport noise.	Same as $L_{\text{dn}}$ with an additional penalty of 4.77 dBA (or $10\log 3$ ), for the hours 7 p.m. to 10 p.m., which are usually reserved for relaxation, television, reading, and conversation
Sound exposure level. Used mainly for aircraft noise, it enables comparing noise created by a loud but fast overflight with that of a quieter but slow overflight.	The acoustical energy during a single noise event, such as an aircraft overflight, compressed into a period of 1 second, expressed in decibels

### 2.2.2.3 Calculating Noise Descriptors

The following formulae and examples may be used to calculate various noise descriptors from instantaneous noise vs. time data.

#### Statistical Descriptor

$L_x$ , a statistical descriptor, signifies the noise level that is exceeded  $X$  % of the time. This descriptor was formerly used in highway noise, before  $L_{\text{eq}}$ . The most common value of  $X$  was 10, denoting the level that is exceeded 10% of the time. Therefore, the  $L_{10}$  descriptor is used as an example to represent the  $L_x$  family of calculations. The following instantaneous noise samples (Table 2-12) shown as a frequency distribution (dBA vs. number of occurrences) serve to illustrate the  $L_{10}$  calculation.

Fifty samples were taken at 10-second intervals. To determine  $L_{10}$ , identify the five highest values (10% of 50) and then count down five values from the top. The “boundary” of the top 10% is 76 dBA. Therefore,  $L_{10}$  lies at 76 dBA.  $L_{50}$  would be at 66 dBA (25 occurrences from the top).

**Table 2-12. Noise Samples for  $L_{10}$  Calculation**

Noise Level (dBA)	Occurrences (Sampling Interval of 10 Seconds) (Each X Is One Occurrence)							Total Occurrences
80								0
79								0
78	X							1
77	X							1
76	X	X	X					3
75	X	X						2
74	X	X						2
73	X	X						2
72								0
71	X	X	X					3
70	X							1
69	X	X						2
68	X	X	X	X	X			5
67	X	X						2
66	X	X	X	X				4
65	X	X	X	X	X	X	X	7
64	X	X	X	X	X			5
63	X	X	X					3
62	X	X	X					3
61	X	X						2
60	X	X						2
<b>Total samples</b>								<b>50</b>

### Equivalent Noise Level

$L_{eq}$  is an energy average noise level.  $L_{eq}$  is also called an energy-mean noise level. The instant noise levels over a certain time period are energy-averaged by first converting all dBA values to relative energy values. Next, these values are added and the total divided by the number of values. The result is average (relative) energy. The final step is to convert the average energy value back to a decibel level. Equation 2-12 showed the method of adding the energy values. This equation can be expanded to yield  $L_{eq}$ :

$$L_{eq} = 10\log_{10}[(10^{SPL_1/10} + 10^{SPL_2/10} + \dots + 10^{SPL_n/10})/N] \quad (2-19)$$

Where:

$SPL_1, SPL_2, SPL_n$  = first, second, and  $n$ th noise level

$N$  = number of noise level samples

#### Example

Calculate  $L_{eq}$  of the following noise instantaneous samples, taken at 10-second intervals:

- 10:00:10: 60 dBA
- 10:00:20: 64 dBA
- 10:00:30: 66 dBA
- 10:00:40: 63 dBA
- 10:00:50: 62 dBA
- 10:01:00: 65 dBA

Using Equation 2-19:

$$L_{eq} = 10\log_{10}[(10^{60/10} + 10^{64/10} + 10^{66/10} + 10^{63/10} + 10^{62/10} + 10^{65/10})/6] = 10\log_{10}(14235391.3/6) = 63.8 \text{ dBA}$$

Usually, longer time periods are preferred. Using the sampling data in Table 2-12, the following equation can be used to add the dBA levels for each set of equal noise levels:

$$SPL_{Total} = SPL_1 + 10\log_{10}(N) \quad (2-20)$$

Where:

$SPL_1$  = SPL of one source

$N$  = number of identical noise levels to be added (in this case, number of occurrences of each noise level)

Next, the following equation can be used to add the subtotals:

$$SPL_{Total} = 10\log_{10}(10^{SPL_1/10} + 10^{SPL_2/10} + \dots + 10^{SPL_n/10}) \quad (2-21)$$

Finally, this amount must be energy-averaged to compute  $L_{eq}$ . This may be accomplished using the following equation:

$$L_{eq} = 10\log_{10}(10^{SPL_{Total}/10}/N) \quad (2-22)$$

Where:

N = total number of samples (in this case, 50)

The calculation procedures are shown in Table 2-13.

**Table 2-13.** Noise Samples for  $L_{eq}$  Calculation

Noise Level (dBA)	Occurrences (N) (from Table 2-12)	Total Noise Levels [dBA + $10\log_{10}(N)$ ]
80	0	
79	0	
78	1	78
77	1	77
76	3	80.8
75	2	78
74	2	77
73	2	76
72	0	
71	3	75.8
70	1	70
69	2	72
68	5	75
67	2	70
66	4	72
65	7	73.5
64	5	71
63	3	67.8
62	3	66.8
61	2	64
60	2	63
<b>Total</b>	<b>50</b>	<b>87.5</b>
<b><math>L_{eq} = 10\log_{10}[(10^{8.75})/50] = 70.5</math> dBA</b>		

## Day-Night Noise Level

$L_{dn}$  is actually a 24-hour  $L_{eq}$ , or the energy-averaged result of 24 1-hour  $L_{eq}$ s, except that the nighttime hours (10 p.m. to 6 a.m.) are assessed a 10-dBA penalty. This penalty attempts to account for the fact that nighttime noise levels are potentially more disturbing than equal daytime noise levels. Mathematically,  $L_{dn}$  is expressed as follows:

$$L_{dn} = 10 \log_{10} \left[ \left( \frac{1}{24} \right) \sum_{i=1}^{24} 10^{L_{eq}(h)_i + W_i/10} \right] \quad (2-23)$$

Where:

$W_i = 0$  for day hours (7 a.m. to 10 p.m.)

$W_i = 10$  for night hours (10 p.m. to 7 a.m.)

$L_{eq}(h)_i = L_{eq}$  for  $i$ th hour

To calculate  $L_{dn}$  accurately, one must have 24 successive hourly  $L_{eq}$  values, representing one typical day. The hourly values between 10 p.m. and 7 a.m. (nine hourly values) must first be weighted by adding 10 dBA. An example is shown in Table 2-14.

The energy average calculated from the nine weighted and 15 unweighted hourly  $L_{eq}$  values is the  $L_{dn}$ . Once the hourly data is properly weighted, the  $L_{dn}$  can be calculated as an  $L_{eq}$  (in this case, a weighted 24-hour  $L_{eq}$ ). Equation 2-19 can be used with the weighted data. The resulting  $L_{dn}$  is 65 dBA.

**Table 2-14.** Noise Samples for  $L_{dn}$  Calculations

Begin Hour	$L_{eq}(h)$ (dBA)	Weight (dBA)	Weighted Noise (dBA)
Midnight	54	+10	64
1 a.m.	52	+10	62
2 a.m.	52	+10	62
3 a.m.	50	+10	60
4 a.m.	53	+10	63
5 a.m.	57	+10	67
6 a.m.	62	+10	72
7 a.m.	65	0	65
8 a.m.	63	0	63
9 a.m.	64	0	64
10 a.m.	66	0	66
11 a.m.	66	0	66
Noon	65	0	65
1 p.m.	65	0	65
2 p.m.	63	0	63
3 p.m.	65	0	65
4 p.m.	65	0	65
5 p.m.	63	0	63
6 p.m.	64	0	64
7 p.m.	62	0	62
8 p.m.	60	0	60

Begin Hour	$L_{eq}(h)$ (dBA)	Weight (dBA)	Weighted Noise (dBA)
9 p.m.	58	0	58
10 p.m.	57	+10	67
11 p.m.	55	+10	65

## Community Noise Equivalent Level

CNEL is the same as  $L_{dn}$  except for an additional weighting of almost 5 dBA for the evening hours between 7 p.m. and 10 p.m. The equation is essentially the same as Equation 2-23, with an additional definition of  $W_i = 10\log_{10}(3)$ , which is 4.77. Calculations for CNEL are similar to  $L_{dn}$ . The result is normally about 0.5 dBA higher than  $L_{dn}$  using the same 24-hour data. The equation for the CNEL is as follows:

$$CNEL = 10\log_{10} \left[ \left( \frac{1}{24} \right) \sum_{i=1}^{24} 10^{L_{eq}(h)_i + W_i/100} \right] \quad (2-24)$$

Where:

$W_i = 0$  for day hours (7 a.m. to 7 p.m.)

$W_i = 10\log_{10}(3) = 4.77$  for evening hours (7 p.m. to 10 p.m.)

$W_i = 10$  for night hours (10 p.m. to 7 a.m.)

$L_{eq}(h)_i = L_{eq}$  for the  $i$ th hour

The 24-hour data used in the  $L_{dn}$  example yields a CNEL of 65.4 dBA, compared with an  $L_{dn}$  of 65.0 dBA.

## Sound Exposure Level

The sound exposure level (SEL) is useful in comparing the acoustical energy of different events involving different source characteristics. For example, the overflight of a slow propeller-driven plane may not be as loud as a jet aircraft. However, the duration of the noise is longer than the duration of the noise from the jet aircraft overflight. SEL makes a noise comparison of both events possible because it combines the effects of time and level. For example, the  $L_{eq}$  of a steady noise level will remain unchanged over time. It will be the same whether calculated for a time period of 1 second or 1,000 seconds. The SEL of a steady noise level, however, will keep increasing because all the acoustical energy within a given time period is included in the reference time period of 1 second. Because both values are energy-weighted, they are directly related to each other by time, as shown in the following equations:

$$\text{SEL} = L_{\text{eq}}(\text{T}) + 10\log_{10}(\text{T}) \quad (2-25)$$

$$L_{\text{eq}}(\text{T}) = \text{SEL} + 10\log_{10}(1/\text{T}) = \text{SEL} - 10\log_{10}(\text{T}) \quad (2-26)$$

Where:

T = duration of noise level in seconds

### Example

$L_{\text{eq}}$  of a 65-second aircraft overflight is 70 dBA. What is the SEL?

$$\text{SEL} = L_{\text{eq}}(65) + 10\log_{10}(65) = 70 + 18.1 = 88.1 \text{ dBA}$$

A time period of 1 hour (T = 3,600 seconds) is commonly used for the  $L_{\text{eq}}$  descriptor when it is applied to criteria in policies and standards. The SEL value accumulated over the 1-hour period can be converted to  $L_{\text{eq}}(\text{h})$  as follows.  $L_{\text{eq}}(\text{h}) = \text{SEL} - 10\log_{10}(3,600)$ , or  $88.1 - 35.6 = 52.5$  dBA for the example above. Because a conversion from SEL to  $L_{\text{eq}}(\text{h})$  always involves subtraction of the constant 35.6 and the following relationships between SEL and  $L_{\text{eq}}(\text{h})$  always hold true:

$$L_{\text{eq}}(\text{h}) = \text{SEL} - 35.6 \quad (2-27)$$

$$\text{SEL} = L_{\text{eq}}(\text{h}) + 35.6 \quad (2-28)$$

These relationships have many practical applications when one is adding a mixture of SELs and  $L_{\text{eq}}(\text{h})$ s. For example, one wants to calculate the existing worst hour noise level in  $L_{\text{eq}}(\text{h})$  at a receiver A from the following data.

- Highway noise = 63 dBA,  $L_{\text{eq}}(\text{h})$
- Two train passbys with SELs of 89 dBA each
- Five aircraft overflights averaging SELs of 93 dBA each

First, all SELs are added:

$$\text{Total SEL} = 10\log_{10}[2(10^{89/10}) + 5(10^{93/10})] = 100.6 \text{ dBA}$$

Next, the SEL is expanded to 1 hour using Equation 2-28:

$$L_{\text{eq}}(\text{h}) = 100.6 - 35.6 = 65 \text{ dBA}$$

Finally, the  $L_{\text{eq}}(\text{h})$  of the highway is added:

$$\text{Worst hour noise level at receiver A} = 10\log_{10}(10^{63/10} + 10^{65/10}) = 67.1 \text{ dBA}$$



## 2.2.3 Conversion between Noise Descriptors

Although Caltrans exclusively uses  $L_{eq}$ , there are times that comparisons need to be made with local noise standards, most of which are in terms of  $L_{dn}$  or CNEL. If 24-hour traffic and noise data are available, these descriptors can be calculated accurately. However, this information is often not available. The methodologies in this section allow a reasonably accurate conversion of the worst hourly noise level to  $L_{dn}$  or CNEL (and vice versa).

Before these conversions are discussed, it should be noted that although these conversions are reasonably accurate, they are only approximate for various reasons. First is the assumption that 24 hourly traffic mixes remain constant and that traffic speeds do not change. Second, the method assumes that the peak hour traffic coincides with the worst-hour  $L_{eq}$ , which is often not true. Nevertheless, the methods of conversion discussed may be used if only average daily traffic (ADT) volumes are known and a reasonable estimate can be made of the percentage of peak hour traffic volume of the ADT. Another requirement is a reasonable estimate of the day and night traffic volume split for  $L_{dn}$  and day, evening, and night split for CNEL.

The previous section discussed that  $L_{dn}$  is defined as an energy-averaged 24-hour  $L_{eq}$  with a nighttime penalty of 10 dBA assessed to noise levels between 10 p.m. and 7 a.m. If traffic volumes, speeds, and mixes were to remain constant throughout the entire 24 hours and there were no nighttime penalty, there would be no peak hour and each hourly  $L_{eq}$  would equal the 24-hour  $L_{eq}$ . Hourly traffic volumes would then be  $100/24$ , or 4.17% of ADT. Peak hour corrections would not be necessary in this case. (Let this be the reference condition.)

To convert peak hour  $L_{eq}$  to  $L_{dn}$ , at least two corrections must be made to the reference condition. First, one must make a correction for peak hour traffic volumes expressed as a percentage of ADT. Second, one must make a correction for the nighttime penalty of 10 dBA. For CNELs, a third correction needs to be made for the evening hour penalty. For this one must know what fractions of the ADT occur during the day and at night. Depending on the accuracy desired and information available, other corrections can be made for different day/night traffic mixes and speeds; these are not discussed in this section.

The first correction for peak hour can be expressed as:

$$10\log_{10} \frac{4.17}{P}$$

Where:

P = peak hour volume as percent of ADT

The second correction for nighttime penalty of 10 dBA is:

$$10\log_{10}(D + 10N)$$

Where:

D = day fraction of ADT

N = night fraction of ADT

D + N = 1

The following equations are used to convert from peak hour  $L_{eq}$  to  $L_{dn}$ , and vice versa, respectively:

$$L_{dn} = L_{eq}(h)_{pk} + 10\log_{10} \frac{4.17}{P} + 10\log_{10}(D + 10N) \quad (2-29)$$

$$L_{eq}(h)_{pk} = L_{dn} - 10\log_{10} \frac{4.17}{P} - 10\log_{10}(D + 10N) \quad (2-30)$$

Where:

$L_{eq}(h)_{pk}$  = peak hour  $L_{eq}$

P = peak hour volume % of ADT

D = daytime fraction of ADT

N = nighttime fraction of ADT

D + N = 1

#### Example

Peak hour  $L_{eq}$  at a receiver near a freeway is 65.0 dBA. Peak hour traffic is 10% of ADT. Daytime traffic volume is 85% of ADT, and nighttime traffic volume is 15% of ADT. Assume that the day and nighttime heavy truck percentages are equal and traffic speeds do not vary significantly. What is the estimated  $L_{dn}$  at the receiver?

$$L_{dn} = 65.0 + 10\log_{10} \frac{4.17}{10} + 10\log_{10}(0.85 + 1.50) = 65.0 + (-3.8) + 3.70 = 64.9 \text{ dBA}$$

Please note that in this example, which is a fairly typical case,  $L_{dn}$  is approximately equal to  $L_{eq}(h)_{pk}$ . The general rule is that  $L_{dn}$  is within about 2 dBA of  $L_{eq}(h)_{pk}$  under normal traffic conditions.

The following equations are used to convert from peak hour  $L_{eq}$  to CNEL, and  $L_{dn}$  to peak hour  $L_{eq}$ , respectively:

$$\text{CNEL} = L_{\text{eq}}(\text{h})_{\text{pk}} + 10\log_{10} \frac{4.17}{\text{P}} + 10\log_{10}(\text{d} + 4.77\text{e} + 10\text{N}) \quad (2-31)$$

$$L_{\text{eq}}(\text{h})_{\text{pk}} = \text{CNEL} - 10\log_{10} \frac{4.17}{\text{P}} - 10\log_{10}(\text{d} + 4.77\text{e} + 10\text{N}) \quad (2-32)$$

Where:

The variables  $d$  and  $e$  are further divisions of  $D$  shown in  $L_{\text{dn}}$  to account for day and evening hours. Please note that  $d + e = D$  (shown in Equations 2-31 and 2-32). The factor 4.77 comes from  $10\log_{10}(3)$ , which is the designated penalty for evening hours in the definition of CNEL. Although an evening hour penalty of 5 dBA is often used to calculate CNEL, the correct value is  $10\log_{10}(3)$ . The difference between using 4.77 and 5 is usually negligible.

#### Example

Using the data for the previous  $L_{\text{dn}}$  example and adding a further division of  $D$  into  $d = 0.80$  and  $e = 0.05$ , the CNEL result using Equation 2-31 is 65.2 dBA, 0.3 dBA more than  $L_{\text{dn}}$ .

From Equations 2-31 and 2-32, the following equations can be derived in terms of CNEL and  $L_{\text{dn}}$ :

$$\text{CNEL} = L_{\text{dn}} + [10\log_{10}(\text{d} + 4.77\text{e} + 10\text{N}) - 10\log_{10}(\text{d} + \text{e} + 10\text{N})] \quad (2-33)$$

$$L_{\text{dn}} = \text{CNEL} - [10\log_{10}(\text{d} + 4.77\text{e} + 10\text{N}) - 10\log_{10}(\text{d} + \text{e} + 10\text{N})] \quad (2-34)$$

#### Example

Using the same example for which  $L_{\text{dn}}$  was 64.9 dBA, the CNEL in Equation 2-33 yields 65.2 dBA. Please note that CNEL is always larger than  $L_{\text{dn}}$ .

The values in Table 2-15 can also be used in Equations 2-29 and 2-30. Please notice that the peak hour percentage term of the equation always yields a negative value, while the weighted day/night split always yields a positive value. The difference between the two is the difference between  $L_{\text{eq}}(\text{h})_{\text{pk}}$  and  $L_{\text{dn}}$ .

**Table 2-15.**  $L_{eq}/L_{dn}$  Conversion Factors

Peak Hour, %	$10\log_{10}(4.17/P)$	Day	Night	$10\log_{10}(D+10N)$
5	-0.8	0.98	0.02	+0.7
6	-1.6	0.95	0.05	+1.6
7	-2.3	0.93	0.07	+2.1
8	-2.8	0.90	0.10	+2.8
9	-3.3	0.88	0.12	+3.2
10	-3.8	0.85	0.15	+3.7
11	-4.2	0.83	0.17	+4.0
12	-4.6	0.80	0.20	+4.5
13	-4.9	0.78	0.22	+4.7
14	-5.3	0.75	0.25	+5.1
15	-5.6	0.73	0.27	+5.4
17	-6.1	0.70	0.30	+5.7
20	-6.8	0.68	0.32	+5.9
		0.65	0.35	+6.2
		0.63	0.37	+6.4
		0.60	0.40	+6.6

Figure 2-19 illustrates the difference between  $L_{eq}(h)_{pk}$  and  $L_{dn}$ . For example, if  $P$  is 10% and  $D/N = 0.85/0.15$ ,  $L_{dn} \approx L_{eq}(h)$ .

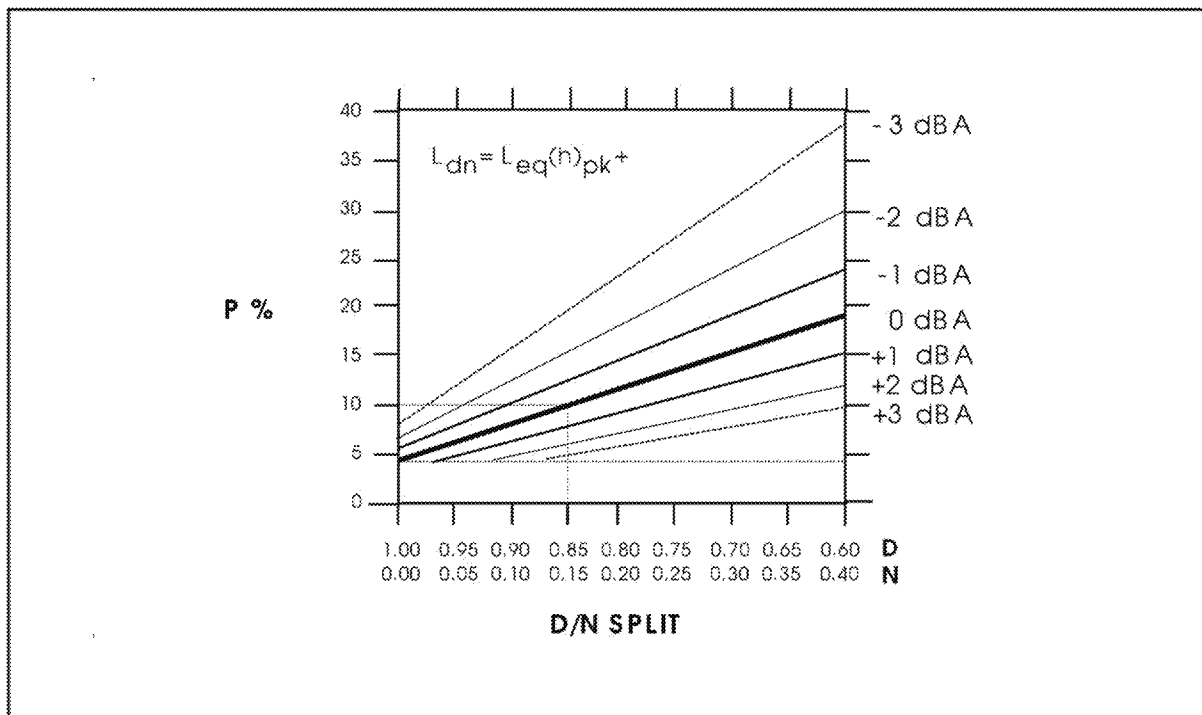

**Figure 2-19.** Relationship between  $L_{dn}$  and  $L_{eq}(h)_{pk}$

If CNEL is desired, the  $L_{dn}$  to CNEL corrections ( $\Delta$ ) in Table 2-16 may be used. Please note that this table is only calculated for a common day/night volume split of 0.85/0.15. Because of the many possible combinations, other tables are not shown. For other D/N splits, use Equation 2-31 or 2-32 to calculate CNEL. This table is intended to be used when only an  $L_{dn}$  is given and CNEL is desired.

**Table 2-16.**  $L_{dn}$ /CNEL Corrections ( $\Delta$ ) (Must Be Added to  $L_{dn}$  to Obtain CNEL)

D	D = 0.85	
	E	$\Delta$ (CNEL = $L_{dn} + \Delta$ )
0.80	0.05	0.3
0.79	0.06	0.4
0.78	0.07	0.5
0.77	0.08	0.5
0.76	0.09	0.6
0.75	0.10	0.7
0.74	0.11	0.7
0.73	0.12	0.8
0.72	0.13	0.8
0.71	0.14	0.9
0.70	0.15	0.9

D = percentage of traffic in hours 7:00 a.m. to 10:00 p.m.  
E = percentage of traffic in hours 7:00 p.m. to 10:00 p.m.  
d = percentage of traffic in hours 7:00 a.m. to 7:00 p.m.  
D = d + E.

The values shown assume a fixed nighttime fractional traffic contribution of 0.15 (D/N split of 0.85/0.15 for  $L_{dn}$ ). The remaining daytime traffic contribution of 0.85 is further subdivided into day ( $d$ ) and evening ( $E$ ) hours. In each instance,  $d + E = 0.85$ .

## 2.2.4 Negative Effects on Humans

The most obvious negative effects of noise are physical damage to hearing. Other obvious effects are the interference of noise with certain activities, such as sleeping and conversation. Less obvious are the stress effects of noise. A brief discussion of each of the topics follows.

### 2.2.4.1 Hearing Damage

A person exposed to high noise levels can suffer hearing damage, either gradual or traumatic. These are described as follows.

- **Gradual:** Sustained exposure to moderately high noise levels over a period of time can cause gradual hearing loss. It starts out as a temporary hearing loss, such as immediately after a loud rock concert. The hearing usually restores itself within a few hours after exposure, although not quite to its pre-exposure level. This is also called a temporary threshold shift. Although the permanent deterioration may be negligible, it will become significant after many repetitions of the exposure. At that time, it is considered permanent hearing damage. The primary cause of permanent hearing damage is daily exposure to industrial noise. Transportation noise levels experienced by communities and the general public are normally not high enough to produce hearing damage.
- **Traumatic:** Short, sudden exposure to an extremely high noise level, such as a gunshot or explosion at very close range, can cause a traumatic hearing loss, which is very sudden and can be permanent.

Hearing damage is preventable by reducing the exposure to loud noise. This can be done by quieting the source, shielding the receiver with a barrier, or having the receiver wear proper ear protection. Occupational exposure to noise is controlled at the Federal Level by OSHA and at the state level by the state level by the California Division of Safety and Health. The maximum allowable noise exposure over an 8 hours period is a level of 90 dBA. For each halving of the exposure time, the maximum noise level is allowed to increase 5 dBA. Therefore, the maximum allowable noise exposure (100%) is 90 dBA for 8 hours, 95 dBA for 4 hours, 100 dBA for 2 hours, 105 dBA for 1 hour, 110 dBA for 30 minutes, and 115 dBA for 15 minutes. Dosimeters, worn by workers in noisy environments, can measure noise during the workday in percentages of the maximum daily exposure.

### 2.2.4.2 Interference with Activities

Activities most affected by noise include rest, relaxation, recreation, study, and communications. Although most interruptions by noise can be considered annoying, some may be considered dangerous, such as the inability to hear warning signals or verbal warnings in noisy industrial situations or situations involving workers next to a noisy freeway. Figure 2-20 gives an estimate of the speech communication that is possible at various noise levels and distances.

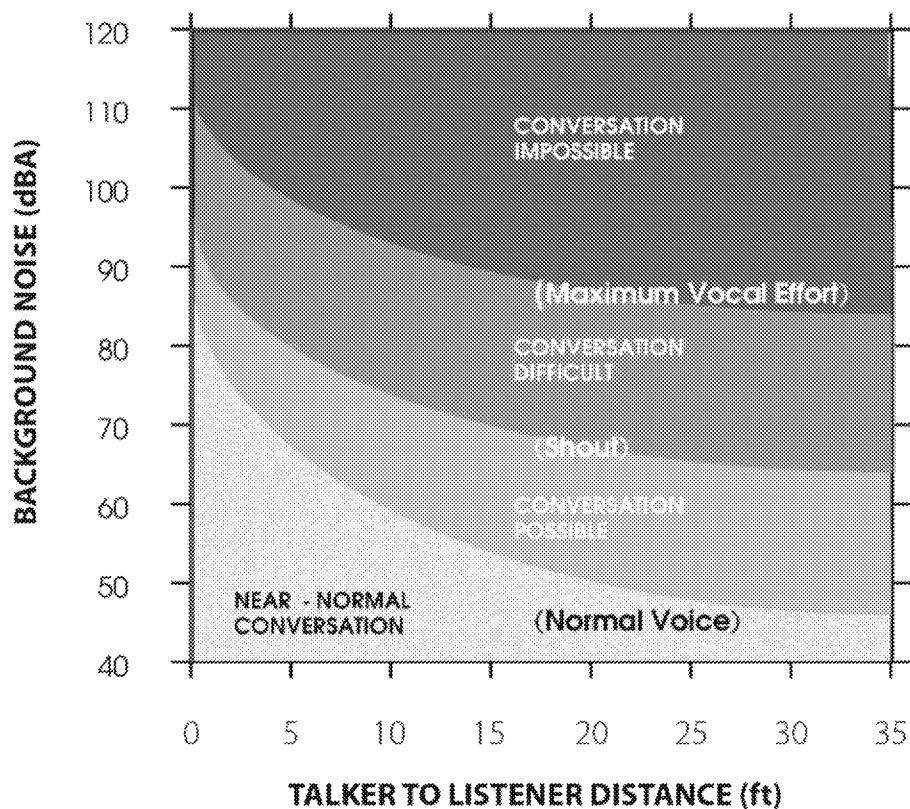

**Figure 2-20.** Interference of Conversation from Background Noise

For example, if the talker-to-listener distance is about 20 feet, normal conversation can be conducted with the background level at about 50 dBA. If the background level is increased to 60 dBA, the talker must either raise his or her voice or decrease the distance to the listener to about 10 feet.

### 2.2.4.3 Stress-Related Diseases

There is ample evidence that noise can cause stress in humans and may be responsible for a host of stress-related diseases, such as hypertension, anxiety, and heart disease. Although noise is probably not the sole culprit in these diseases, it can be a contributor. The degree to which noise contributes to stress-related diseases depends on noise frequencies, their

bandwidths, noise levels, and time patterns. In general, higher frequencies, pure tones, and fluctuating noise levels tend to be more stressful than lower frequencies, broadband, and constant-level noise.



## Measurements and Instrumentation

Noise measurements play an important role in noise analysis and acoustical design of noise attenuation for transportation projects. This section addresses recommendations on why, where, when, and how noise measurements should be taken. A brief discussion on available instrumentation is also included. Because of the variety of sound instrumentation, coverage of equipment setup and operational procedures is discussed only at a general level. For additional detail, manufacturers' manuals should be consulted.

The noise analyst should be aware of both the importance and limitations of noise measurements. As with all field work, quality noise measurements are relatively expensive, requiring time, personnel, and equipment. Therefore, the noise analyst should carefully plan the location, time, duration, and number of repetitions of noise measurements before actually taking the measurements. Efforts should be made during the measurements to document location, traffic levels, weather, and other pertinent factors discussed in this section.

The contents of this section represent Caltrans measurement procedures and are consistent with methods described in FHWA's *Measurement of Highway-Related Noise* (1996a).

### 3.1 Purposes of Noise Measurements

There are five major purposes for measuring transportation noise.

- Determine existing ambient and background noise levels.
- Calibrate noise prediction models.
- Monitor construction noise levels for compliance with standard specifications, special provisions, and local ordinances.
- Evaluate the effectiveness of abatement measures such as noise barriers.
- Perform special studies and research.

Ambient and background noise and model calibration measurements are routinely performed by the Caltrans districts. Construction noise monitoring is also conducted frequently by the districts. Some districts conduct before-and-after noise abatement measurements. Special studies and noise research measurements are done rarely by the districts and are often contracted to consultants with Caltrans oversight.

Where, when, and how noise measurements are performed depends on the purpose of the measurements. The following sections discuss the reasons for the measurements, what they include, and how the results are typically used.

### **3.1.1 Ambient and Background Noise Levels**

Ambient noise levels are all-encompassing noise levels at a given place and time, usually a composite of sounds from all sources near and far, including specific noise sources of interest. Typically, ambient noise levels include highway and community noise levels. Ambient noise levels are measured for the following reasons.

- To assess highway traffic noise impacts for new highway construction or reconstruction projects. Existing ambient noise levels provide a baseline for comparison to predicted future noise levels. The measurements are also used to describe the current noise environment in the area of the proposed project. This information is reported in appropriate environmental documents. Generally, the noise resulting from natural and mechanical sources and human activity considered usually to be present should be included in the measurements.
- To investigate citizens' traffic or construction noise complaints. Noise measurements are usually reported via memorandum to the interested party, with recommendations for further actions or reasons that further actions are not justified.

Background noise is considered to be the total noise in a specific region without the presence of noise sources of interest. Typically, this would be the noise generated within the community without the highway and is usually measured at acoustically representative locations away from the highway where highway noise does not contribute to the total noise level. Background noise levels are routinely measured to determine the feasibility of noise abatement and to ensure that noise reduction goals can be achieved. Noise abatement cannot reduce noise levels below background levels. Section 5.1.6 discusses the importance of background noise levels.

Depending on the situation, noise sources measured may typically include highway traffic, community activity, surface street traffic, trains, and sometimes airplanes (when project is near an airport).

### **3.1.2 Model Validation/Calibration**

Noise measurements near highways or other transportation corridors are routinely used to validate and, if necessary, calibrate the project-specific TNM model by comparing calculated noise levels with actual (measured) noise levels. The calculated levels are modeled results obtained from traffic counts and other parameters recorded during the noise measurements. The difference between calculated and measured noise levels may then be applied to calculated future noise levels, assuming site conditions will not change significantly, or modeled existing noise levels (see Sections 4.3.3 and 4.4). Model calibration can only be performed on projects involving reconstruction of existing highways.

### **3.1.3 Construction Noise Levels**

Construction noise measurements are frequently conducted by districts to check the contractor's compliance with the standard specifications, special provisions, and local ordinances.

### **3.1.4 Performance of Abatement Measures**

Before-and-after abatement measurements can be used to evaluate the performance of noise barriers, building insulation, or other abatement options. The measurements provide a check on the design and construction procedures of the abatement. Although these measurements are occasionally performed by some districts, they are not part of a routine program.

### **3.1.5 Special Studies and Research**

These measurements are usually done by Caltrans headquarters staff and consultants. They may involve district assistance and generally involve noise research projects. Setups are usually complex and include substantial equipment and personnel positioned at many locations for simultaneous noise measurement. The studies generally require more sophisticated equipment and setups than routine noise studies.

## 3.2 Measurement Locations

The selection of measurement locations requires considerable planning and foresight by the noise analyst. A fine balance must be achieved between sufficient quality locations and the cost in person hours. Good engineering judgment must be exercised in site selection; experience makes this task easier.

Many tools are available in the search for quality noise measurement sites. Preliminary design maps, cross sections, aerial photographs, and field survey data are all helpful sources of information. However, noise measurement sites should only be selected after a thorough field review of the project area.

### 3.2.1 General Site Recommendations

Some general site requirements common to all outside noise measurement sites are listed below (more detailed considerations are discussed in Section 3.2.2).

- Sites must be clear of major obstructions between the source and receiver unless these are representative of the area of interest. Small reflecting surfaces should be more than 10 feet from the microphone positions. Large reflecting surfaces should be avoided unless they are the subject of study.
- Sites must be free of noise contamination by sources other than sources of interest. Avoid sites located near sources such as barking dogs, lawnmowers, pool pumps, and air conditioners unless it is the express intent of the analyst to measure these sources.
- Sites must be acoustically representative of areas and conditions of interest. They must either be located at or represent locations of human use.
- Sites must not be exposed to prevailing meteorological conditions that are beyond the constraints discussed in this section. For example, in areas with prevailing high wind speeds, sites in open fields should be avoided.

### 3.2.2 Measurement Site Selection

For the purpose of this document, a distinction will be made between receivers and noise measurement sites. Receivers are all locations or sites of interest in the noise study area. Noise measurement sites are locations

where noise levels are measured. Unless an extremely rare situation exists in which a noise measurement site is used for a specialized purpose, all noise measurement sites may be considered receivers. However, not all receivers are noise measurement sites. Additional information on receivers and noise measurement sites can be found in Section 4.3.

For describing existing noise levels at selected receivers, measured noise levels are normally preferred. Restricted access or adverse site conditions may force the selection of noise measurement sites at locations that are physically different from but acoustically equivalent to the intended receivers. In some cases, measurements are not feasible. In such cases, the existing noise levels must be modeled. This can only be accomplished along an existing facility, where traffic data can be collected.

In general, there will be more modeled receivers than noise measurement sites. It is far less expensive to take noise measurements at selected, representative receivers and then model the results for the remaining receivers. Nevertheless, there needs to be an adequate overlap of measurement sites and modeled receivers for model calibration and verification.

Factors that should be considered when selecting noise measurement sites are described in the next three sections.

### **3.2.2.1 Site Selection by Purpose of Measurement**

Noise measurement sites should be selected according to the purpose of the measurement. For example, if the objective is to determine noise impacts of a highway project, sites should be selected in areas that will be exposed to the highest noise levels generated by the highway after completion of the project. The sites should also represent areas of human use. Conversely, if the objective is to measure background community noise levels, the sites should be located in areas that represent the community without influence from the highway. These measurements are often necessary for acoustical noise barrier design and to document pre-project noise levels at distant receivers. Past controversies concerning reported increases in noise levels at distant receivers attributed to noise barriers could have been readily resolved if sufficient background noise measurements had been obtained prior to the project being built. (Refer to Section 3.1.1 for more information on background noise levels).

Classroom noise measurements (Street and Highways Code Section 216) or receivers lacking outside human use require both inside and outside noise measurements in rooms with worst noise exposures from the highway. Measurements should generally be made at a point in a room,

hall, or auditorium where people would be affected by infiltrating noise from the sources of interest. These points are typically desks, chairs, or beds near windows. Several sensitive points may need to be tested, and the results averaged. No measurements should be made within 3 to 4 feet of a wall. It is also important to take measurements in the room in its typical furnished condition. If windows are normally open, measurements should be taken with windows open and closed. Devices such as fans, ventilation, clocks, appliances, and telephones should be turned off. People should vacate the room or be extremely quiet.

Model calibration measurements usually require sites to be near the highway, preferably at receivers or acoustical equivalents to the receivers (see Section 4.4 for additional details). Sites for construction noise monitoring are dictated by standard specifications, special provisions, and local ordinances, which detail maximum allowable noise levels at a reference distance (e.g.,  $L_{\max}$  of 86 dBA at 50 feet) and other requirements.

Before-and-after measurements for evaluations of noise barriers and other abatement options, as well as measurements for special studies or research, are non-routine and require a detailed experimental design. Coordination with Caltrans Headquarters staff is advisable.

### **3.2.2.2 Site Selection by Acoustical Equivalence**

Noise measurement sites should be representative of the areas of interest. Representativeness in this case means *acoustical equivalence*. The concept of acoustical equivalence incorporates equivalences in noise sources, distances from these sources, topography, and other pertinent parameters.

The area under study may need to be divided into sub-areas in which acoustical equivalence can generally be maintained. Sub-area boundaries must be estimated by one or more of the previously mentioned acoustical parameters. Also, in cases where measurements are being taken for more than one purpose, separate sub-areas may be defined by each purpose. The areas of interest may vary in size. For example, noise abatement for a school may cover only the school itself, while a noise study for a large freeway project may range from a large area to many sub-areas.

The number of measurement sites selected within each area or sub-area under study depends on the area's size, number of receivers, and remaining variations in acoustical parameters. If sub-areas are carefully selected, the number of measurement sites can be minimized. The minimum number of sites recommended for each area or sub-area is two.

Figure 3-1 shows an example of receiver and noise measurement site selections for an at-grade freeway widening and noise barrier project. Alternate noise measurement sites to be used if the selected receivers are not accessible or otherwise not suitable for noise measurement locations are shown also. Only sites near the freeway are shown. Background noise measurement sites would typically be off the map, farther from the freeway. Actual site selection would depend on field reviews and more information not shown on the map.

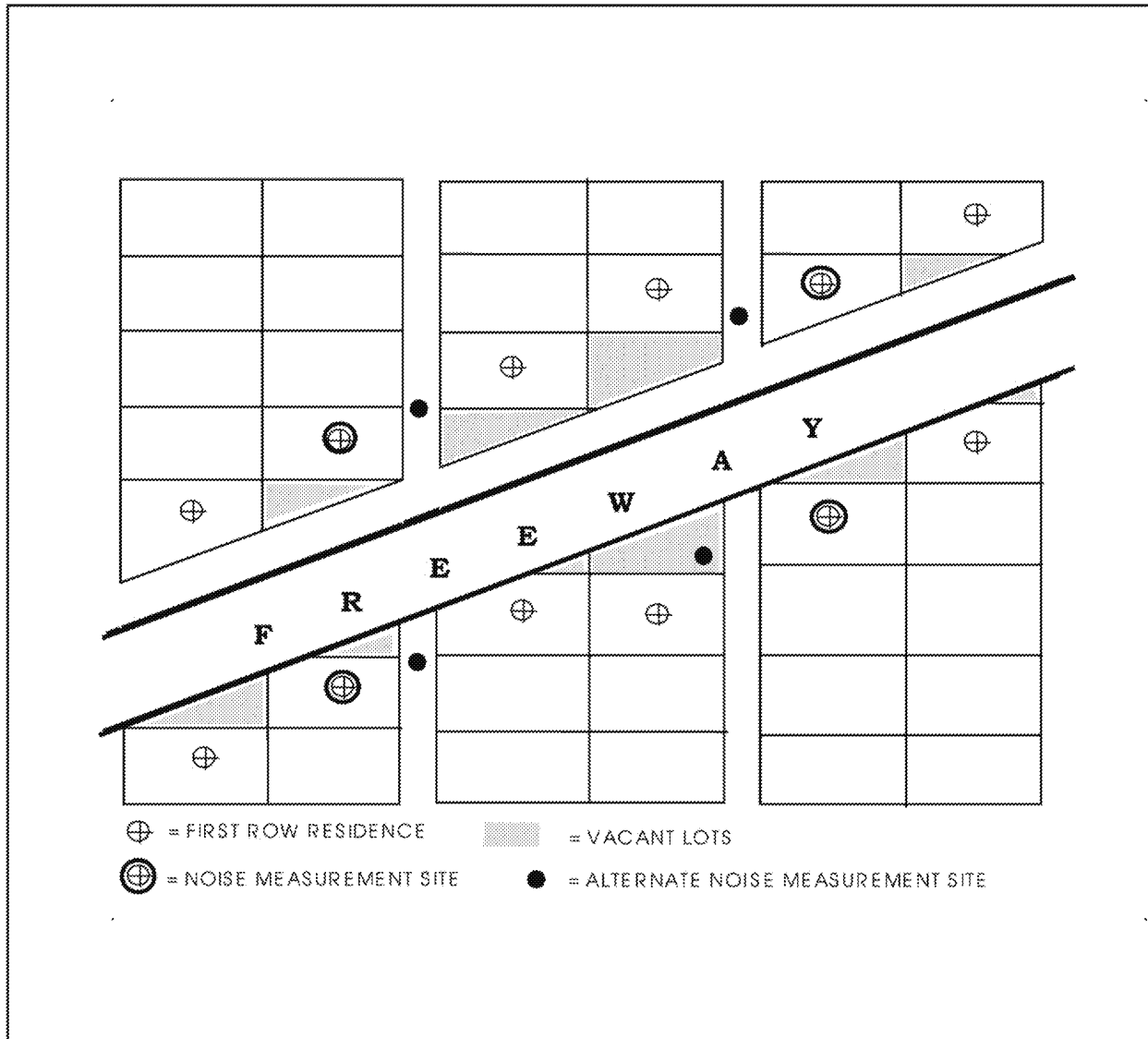

Figure 3-1. Typical Measurement Site Locations

### 3.2.2.3 Site Selection by Geometry

In addition to being an important consideration in determining acoustical equivalence, topography (site geometry) plays an important role in determining locations of worst exposure to highway noise. Receivers located farther from a highway may be exposed to higher noise levels, depending on the geometry of a site. One typical example is a highway on a high embankment, where the first-tier receivers may be partially shielded by the top of the fill. Unshielded second- or third-tier receivers may then be exposed to higher noise levels even though they are farther from the source. This concept is shown in Figure 3-2. Another common situation involves a receiver close to the source, shielded by the top of a highway embankment, and an unshielded receiver farther from the source. The attenuation provided by the embankment is often more than the distance effect, resulting in higher noise levels at the farther receiver.

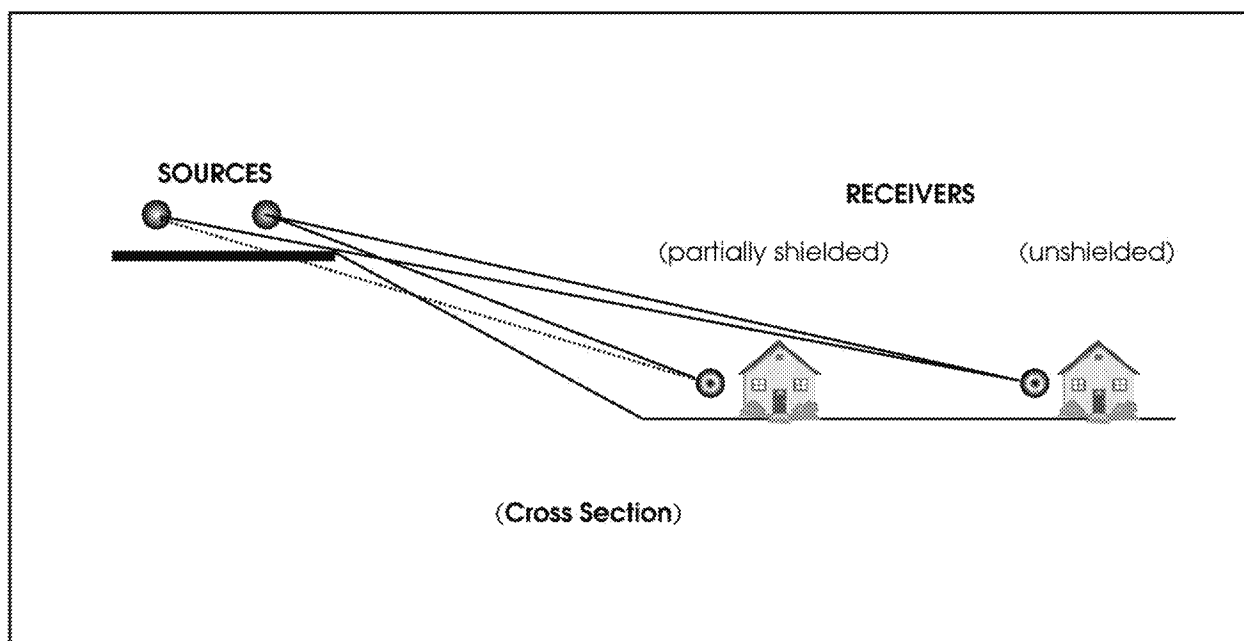

Figure 3-2. Typical Noise Measurement Site Locations

Figure 3-3 illustrates another example of the effects of site geometry on the selection of highest noise exposure. The unshielded Receiver 1 shows a higher noise level than Receiver 2 even though the latter is closer to the freeway. Other examples can be generated in which the nature of terrain and natural or artificial obstructions cause noise levels at receivers closer to the source to be lower than those farther away. This concept is an important consideration in impact analysis, where interest usually focuses on the noisiest locations.



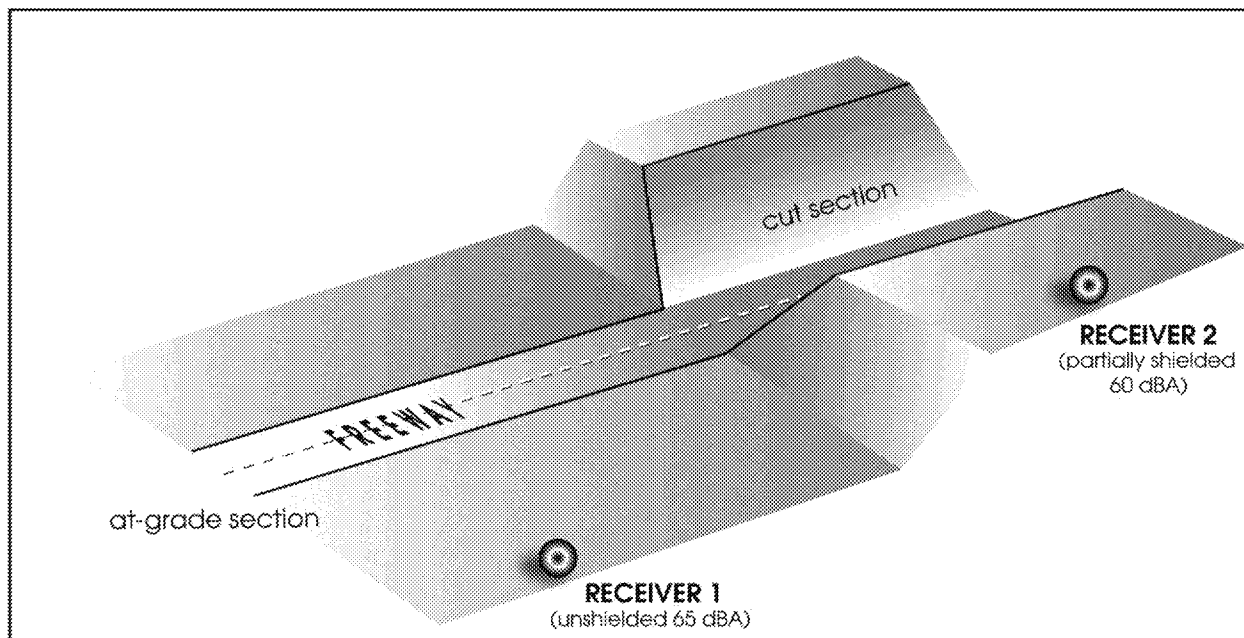

Figure 3-3. Receiver Partially Shielded by Top of Cut vs. Unshielded Receiver

## 3.3 Measuring Times, Duration, and Number of Repetitions

### 3.3.1 Measuring Times

23 CFR 772 requires that traffic characteristics that yield the worst hourly traffic noise impact on a regular basis be used for predicting noise levels and assessing noise impacts. Therefore, if the purpose of the noise measurements is to determine a future noise impact by comparing predicted noise with measured noise, the measurements must reflect the highest existing hourly noise level that occurs regularly. In some cases, weekly or seasonal variations need to be considered. In recreational areas, weekend traffic may be higher than on weekdays and may be heavily influenced by season, depending on the type of recreation. Measurements made for retrofit noise barrier projects also require noise measurements during the highest traffic noise hour.

The noise impact analysis for classrooms, under the provisions of the Streets and Highways Code Section 216, requires noise measurements to be made “at appropriate times during regular school hours” and sets an indoor noise limit of 52 dBA,  $L_{eq}(h)$ , from freeway sources. Therefore, noise measurements for schools qualifying for school noise abatement under Section 216 need to be made during the noisiest traffic hour during

school hours. Noise from school children often exceeds traffic noise levels. To avoid contaminated measurements, it is often necessary to vacate classrooms for the duration of the measurements or to take measurements during vacation breaks.

Noise measurements for model calibration do not need to be made during the worst noise hour, but it is desirable to have about the same estimated traffic mix (e.g., heavy truck percentages of the total volume) and speeds as during the noisiest hour. Accurate traffic counts and meteorological observations (see Section 3.6) must be made during these measurements.

Noise monitoring for background community noise levels should be done during the expected time of the highest noise level from the highway even though the measurements are taken at sites far enough removed from an existing highway that they will not be contaminated by it. This should be done because the background levels will later be added to predicted near-highway noise levels.

Noise monitoring for investigating citizen complaints may need to be done at a time to which the parties mutually agree. Frequently, these measurements are taken before or after normal working hours, as dictated by the nature of the complaint.

Construction monitoring is performed during operation of the equipment to be monitored. This may require night work on some construction projects.

Unless other times are of specific interest, before-and-after noise abatement (e.g., noise barrier) measurements to verify noise abatement performance should be done during the noisiest hour. Noise barriers are designed for noisiest hour traffic characteristics, which probably include highest truck percentages, and to minimize contamination by background noise. Traffic should be counted during these measurements. If before-and-after traffic conditions differ, measurements should be normalized or adjusted to the same conditions of traffic (see Section 3.3.1.2).

The nature of special studies and research projects dictates the appropriate times for those measurements.

### **3.3.1.1 Noisiest Hour for Highway Traffic**

The peak traffic hour is generally not the noisiest hour. During rush hour traffic, vehicle speeds and heavy truck volumes are often low. Free-flowing traffic conditions just before or after rush hour often yield higher noise levels. Preliminary noise measurements at various times of the day

are sometimes necessary to determine the noisiest hour. If accurate traffic counts and speeds for various time periods are available, the noisiest hour may be determined by using TNM. Experience based on previous studies may also be valuable in determining the noisiest hour for a particular facility.

### **3.3.1.2 Adjusting Other-Than-Noisiest Hour**

For the sake of efficiency, highway traffic noise measurements are often not made when the highest hourly traffic noise levels occur. These measurements may be adjusted upward to noisiest hour levels by using TNM. To make the adjustments, traffic must be counted and speeds determined simultaneously with the noise measurements. The following procedure must be followed.

1. During each measurement, take noise measurements and count traffic simultaneously. Although lane-by-lane traffic counts yield the most accurate results, it is usually sufficient to count traffic by direction (e.g., east- and westbound). Separate vehicles into the five vehicle groups used by the model (autos, medium trucks, heavy trucks, buses, and motorcycles). Obtain average traffic speeds (both directions). These may be obtained by radar or driving a test vehicle through the project area at the prevailing traffic speed.
2. Expand vehicle counts for the measurement period to hourly values (e.g., if the measurement period was 15 minutes, multiply the vehicles counted in each group by 4). Section 3.3.2 discusses duration of measurement as a function of hourly vehicle volumes.
3. Enter the hourly traffic volumes and speeds from steps 1 and 2 into TNM. Also include the proper roadway and receiver geometry and site parameters. Run the model.
4. Enter the traffic volumes and speeds associated with the noisiest hour and the same roadway and receiver geometry and site parameters as used in step 3. Run the model.
5. Subtract results of step 3 from step 4. The step 4 results should always be larger than step 3.
6. Add the differences obtained in step 5 to the noise measurements of step 1.

**Example**

Measured noise level in step 1,  $L_{eq} = 66$  dBA

Calculated for step 1 conditions (step 3) = 67 dBA

Calculated for noisiest hour (step 4) = 69 dBA

Difference (step 5) = 2 dBA

Measured noise level adjusted to noisiest hour (step 6) =  $66 + 2 = 68$  dBA

If 24-hour monitoring equipment is available, a histogram of 24 hourly noise measurements may be developed for an existing freeway. This information may then be used to adjust an off-peak hour noise level at any location along the freeway to a noisiest hour noise level. However, steps must be taken to reduce the chance of noise contamination from non-traffic sources. If hourly noise relationships are in agreement between the two monitors, there is reasonable assurance that neither was contaminated. There is, however, no assurance that regional contamination such as frequent aircraft flyovers did not take place. As such, measurements with remote noise monitoring equipment must be approached with extreme caution and only with at least some familiarity of nearby noise sources.

### 3.3.2 Measurement Duration

A noise measurement representing an hourly  $L_{eq}$  does not need to last the entire hour. As long as noise levels do not change significantly, a shorter time period will usually be sufficient to represent the entire hour of interest. The recommended length of measurements depends on how much the noise levels fluctuate—the higher the fluctuations, the longer the measurement must be. Vehicle spacing and differences in vehicle types are responsible for fluctuating noise levels. These fluctuations decline as traffic densities increase. Highway noise also becomes more constant as the distance from the highway increases because the rate of distance change between a moving vehicle and a receiver diminishes. The durations in Table 3-1 are recommended for highway traffic noise measurements as a function of number of vehicles per hour (vph) per lane.

**Table 3-1. Suggested Measurement Durations**

Traffic Volume	Vehicles per Hour per Lane	Duration (Minutes)
High	>1,000	10
Medium	500–1,000	15–20
Low	<500	20–30

Most sound level meters automatically integrate and digitally display cumulative  $L_{eq}$ . Near the beginning of each measurement period, the displays fluctuate considerably. However, after more data are collected, they tend to stabilize. The time necessary to stabilize depends on the amount of noise fluctuation. A measurement may be terminated when the range of the fluctuation in displayed  $L_{eq}$  is less than 0.5 dBA. However, measurements can be lengthened if necessary.

### 3.3.3 Number of Measurement Repetitions

Noise measurements taken at a specific site tend to vary. The most common causes of these variations are listed below.

- Change in traffic volumes, speeds, and/or mixes.
- Contamination from non-traffic noise sources, such as barking dogs, aircraft, nearby construction, and landscaping and road maintenance activities.
- Change in weather (e.g., wind speed, wind direction, temperature, and humidity).
- Changes in site conditions.
- Instrument, operator, or calibration error.
- Malfunctioning instruments.

Because of these potential variables and errors that may occur during a measurement, it is strongly recommended that a time-averaged measurement (e.g., the  $L_{eq}$  descriptor) be repeated at least once at each site. This procedure will reduce the chances of undetected errors. There are exceptions to this recommendation, however. Whenever three or more noise measurements are made in the same general area, simultaneously or in relatively rapid succession, one measurement at each site may be sufficient if the sites are acoustically equivalent (see Section 3.2.2.2). However, to determine whether a measurement at a particular site is acceptable, the measurement should be compared to those at the other sites and subjected to the same criteria for repeat measurements discussed later in this section.

The recommended minimum of two measurements should be taken independently (using two different setups and separate calibrations). However, the operator is not precluded from taking more than one measurement per setup and calibration. In fact, if time permits, multiple measurements during each setup are encouraged to improve accuracy. To

save time concurrent measurements may be made at a single position with two separate instrument setups.

Repeat measurements should be compared with the original measurements under the same conditions of traffic, meteorology, and site. Noise contamination, instrument malfunction, operator error, or any other anomalies in the measurements can then readily be detected. To ensure that conditions are the same for all measurements, traffic counts and some basic meteorological measurements should be made during the noise measurements (see Sections 3.3.4 and 3.6). If the repeat measurements are not in reasonable agreement with the original measurements, additional measurement repetitions are recommended. For routine measurements, such as determining ambient noise levels or calibrating noise prediction models, the above-recommended minimum of two measurements normalized for differences in traffic mix and volumes should agree within 2 dBA. If more than one measurement is taken per setup, the mean noise levels for the two setups should agree within 2 dBA. Repetitive measurements for each setup should then be within about 1 dBA of the mean noise level of the setup.

The above criteria have been set empirically from many years of field experience with a variety of sound level meters approved for transportation noise measurements (American National Institute of Standards [ANSI] S1.4 1983, Types 1 and 2). Some examples illustrating these criteria are listed below and were purposely selected to show the extreme allowable limits. Usually, better agreement between setups and within setups can be expected. Examples 1 to 3 assume that all meteorological conditions, traffic conditions, and site conditions are the same throughout all measurements.

#### **Example 1**

##### Measurement 1

Setup 1: 74.5 dBA,  $L_{eq}$

Setup 2: 76.5 dBA,  $L_{eq}$

**Mean: 75.5 dBA,  $L_{eq}$**

Conclusion: Measurements are acceptable because they agree by 2 dBA.

**Example 2**Measurement 1Setup 1: 69 dBA,  $L_{eq}$ Setup 2: 71 dBA,  $L_{eq}$ Measurement 2Setup 1: 67 dBA,  $L_{eq}$ Setup 2: 69 dBA,  $L_{eq}$ MeanSetup 1: 68 dBA,  $L_{eq}$ Setup 2: 70 dBA,  $L_{eq}$ **Overall: 69 dBA,  $L_{eq}$** 

Conclusion: Measurements are acceptable because they agree by 2 dBA and measurements within each setup are within about 1 dBA of the setups' mean.

**Example 3**Measurement 1Setup 1: 61.6 dBA,  $L_{eq}$ Setup 2: 58.6 dBA,  $L_{eq}$ Measurement 2Setup 1: 59.6 dBA,  $L_{eq}$ 

Setup 2: –

MeanSetup 1: 60.6 dBA,  $L_{eq}$ Setup 2: 58.6 dBA,  $L_{eq}$ **Overall Mean: 59.9 dBA,  $L_{eq}$  (round to 60)**

Conclusion: Measurements are acceptable.

Examples 1 to 3 indicate that as long as the agreement criteria between the two setups and within each setup are met, all measurements can be averaged together. Examples 4 and 5 illustrate the process if the setups do not agree by 2 dBA.

**Example 4**Measurement 1Setup 1: 65.3 dBA,  $L_{eq}$ Setup 2: 68.0 dBA,  $L_{eq}$ 

Conclusion: Measurements are not acceptable; difference of more than 2 dBA).

After the second measurement, a decision should be made to either take another measurement during Setup 2 or break the setup and take a measurement for a new Setup 3. Either method will be acceptable,

although if the decision is to take another measurement during Setup 2, and the agreement criteria still cannot be met, it is recommended to break Setup 2 and perform additional measurements with Setup 3. If agreement is reached between Setups 2 and 3, Setup 1 should be eliminated, as illustrated in Example 5:

### **Example 5**

#### Measurement 1

Setup 1: 65.3 dBA,  $L_{eq}$

Setup 2: 68.0 dBA,  $L_{eq}$

Setup 3: 69.0 dBA,  $L_{eq}$

#### Measurement 2

Setup 1: –

Setup 2: 68.5 dBA,  $L_{eq}$

Setup 3: –

#### Mean

**Setups 2 and 3: 68.5 dBA,  $L_{eq}$**

Conclusion: Setup 2 and 3 measurements are acceptable.

If Setup 3 measurement would have agreed with both Setups 1 and 2 (e.g., 67.0 instead of 69.0), another decision would have to be made, such as one of the following.

- Use Setups 1 and 3.
- Use Setups 2 and 3.
- Use the average of all three setups (all measurements).

The safest approach would be to use the average of all measurements unless there would be a good reason to eliminate one setup.

These examples illustrate some extreme cases; many other combinations are possible. Most measurements will show better agreement. The examples are intended to show how the recommended criteria may be applied in general. The analyst may need to rely more on individual judgment and experience in more complicated situations.

In some cases, more accuracy is required than the criteria allow. These cases apply mostly to special studies or research. However, they may also be applied to a few key noise measurement sites on a large project for the purpose of accurate model calibration. In these cases, a 95% confidence interval for the mean of several measurements (using a minimum of two setups) can be calculated. The 95% confidence interval should be specified to be no more than about 1 dBA. Table 3-2 shows the maximum allowable standard deviations ( $S_{max}$ ) as a function of the number of



samples (measurements). Although the table is calculated for up to 10 measurements, the criterion can be met by five or fewer measurements in most cases. A scientific calculator with statistical functions is essential when making calculations in the field.

**Table 3-2.** Maximum Allowable Standard Deviations for a 95% Confidence Interval for Mean Measurement of about 1 dBA

Number of Measurements	Maximum Allowable Standard Deviations
2	0.11
3	0.40
4	0.63
5	0.81
6	0.95
7	1.08
8	1.20
9	1.30
10	1.40

### **Example**

#### Measurement 1

Setup 1: 67.8 dBA,  $L_{eq}$

Setup 2: 68.7 dBA,  $L_{eq}$

#### Measurement 2

Setup 1: 66.9 dBA,  $L_{eq}$

Setup 2: 67.9 dBA,  $L_{eq}$

#### Measurement 3

Setup 1: –

Setup 2: 67.8 dBA,  $L_{eq}$

#### Standard Deviation (Maximum)

Setups 1 and 2: 0.73 (0.63)

**Setups 1 to 3: 0.64 (0.81)**

#### Mean

**Setups 1 to 3: 67.8 dBA,  $L_{eq}$  (round to 68)**

Conclusion: Use Setups 1 to 3 (five measurements).

The preceding examples assume that the previously mentioned site, traffic, and meteorological conditions remain the same during all measurements. Site conditions and contamination from other noise sources can be controlled by careful site selection. Noise contamination from intermittent

sources can further be controlled by pausing the instruments during the contamination or by marking and editing recorded data.

Operator error and instrument malfunction usually cause larger errors that are easily detected. Instrument error is a function of equipment brand, type, and calibration. Instrument records of calibration, repair, performance, manufacturers' manuals, and accuracy standards (discussed later in Section 3.7) will give a good estimate of instrument error.

The next section addresses a method of normalizing noise measurements made under different traffic conditions. Meteorological limits for comparisons of noise measurements will be discussed in Section 3.6.

### **3.3.4 Normalizing Measurements for Differences in Traffic Mixes and Volumes**

Before applying the criteria discussed in Section 3.3.3, repeated measurements must be adjusted for differences in traffic mix and volume. The effects of traffic differences can be calculated by the noise prediction models and compared with the actual differences in the measurements. However, a simple method to normalize measurements for differences in traffic mixes and volumes has been developed for optional use in the field.

This method involves field calculations that with practice can be carried out in a few minutes with a log function calculator as demonstrated in the discussion below. The repeated measurements are field-adjusted for the same traffic conditions as the first measurement. The adjusted (normalized) measurements may then be compared directly according to the criteria in Section 3.3.3.

The obvious advantage of using this method is that it may eliminate the need to return to the same site at a later date if repetition criteria are not met. However, as with most simplified methods, there are certain limitations to the use of this procedure. The method should not be used in the following cases.

- Average traffic speeds are not the same for each measurement. This is difficult to verify, but under free-flow conditions at a specific location, speeds generally will be constant.
- Truck speeds are significantly different (more than 5 mph) from auto speeds or truck percentages are significantly different (more than doubled).
- Speeds cannot be determined within 5 mph.

- The ratio of distances from the receiver to the centerline of the far (directional) lane group and the receiver to the centerline of the near (directional) lane group is more than 2:1. For most eight-lane urban freeways, this means that the receiver should not be closer than 45 feet from the edge of the traveled way.
- The directional split of traffic is different by more than 20% for each vehicle group between measurements. For example, if the directional split between heavy trucks during the first measurement is 60/40 and 80/20 or 40/60 during the next measurement, the method would be valid. However, a second split of 85/15 or 35/65 means that the method would be inaccurate. This criterion is usually met.

The method uses the concept of equivalent vehicles ( $V_E$ ), which equates medium and heavy trucks to an acoustically equivalent number of autos. Based on the TNM Reference Energy Mean Emission Levels (REMELs) (Federal Highway Administration 1996b), one heavy truck traveling at 55 mph makes as much noise as approximately 10 autos cruising at the same speed. A medium truck at 55 mph is acoustically equivalent to approximately four autos passing at the same speed. These relationships are speed-dependent and the same for the maximum noise level ( $L_{max}$ ) and time-averaged noise levels ( $L_{eq}$ ).

The relationships do not consider source heights and may not be used if the path from the source to the measurement site is intercepted by a barrier or natural terrain feature. Table 3-3 shows  $V_E$  for speeds from 35 to 70 mph in 5-mph increments, based on the FHWA TNM REMELs for baseline conditions.

**Table 3-3.** Equivalent Vehicles Based on Federal Highway Administration Traffic Noise Model Reference Energy Mean Emission Levels

Speed (mph)	Equivalent Vehicles		
	1 Heavy Truck	1 Medium Truck	1 Automobile
35	19.1	7.1	1
40	15.1	5.8	1
45	12.9	5.0	1
50	11.5	4.5	1
55	10.4	4.1	1
60	9.6	3.7	1
65	8.9	3.5	1
70	8.3	3.2	1

Note: Based on FHWA TNM REMELs and vehicle definitions in Federal Highway Administration 1996a and 1996b (also see Section 4.5.2).

The following is an example of calculating  $V_E$  using Table 3-3.

**Given**

In 15 minutes, the following traffic was counted: 76 heavy trucks, 34 medium trucks, and 789 autos. Average traffic speed was 55 mph.

**Solution**

$$76 \text{ heavy trucks} = 76 \times 10.4 = 790 V_E$$

$$34 \text{ medium trucks} = 34 \times 4.1 = 139 V_E$$

$$789 \text{ autos} = 789 \times 1 = 789 V_E$$

$$\text{Total} = 1,718 V_E$$

To normalize a noise measurement for one traffic count to another noise measurement for a different traffic count, the following procedure should be followed:

1.  $L_{eq}(1)$  is the first noise measurement, which is used as the reference measurement. Convert the traffic count for  $L_{eq}(1)$  to  $V_E$ , which is designated  $V_E(1)$ .
2.  $L_{eq}(2)$  is the second noise measurement, which is to be normalized. Convert the traffic count for  $L_{eq}(2)$  to  $V_E = V_E(2)$ .
3.  $c$  is the correction to be applied to  $L_{eq}(2)$  for normalization to the traffic of  $L_{eq}(1)$ . The equation to compute  $c$  is  $10\log_{10}[V_E(1)/V_E(2)]$ . Note that  $c$  may be negative or positive.
4.  $L_{eq}(2N)$  is the normalized  $L_{eq}(2)$ . The equation to compute  $L_{eq}(2N)$  is  $L_{eq}(2) + c$ .
5.  $L_{eq}(2N)$  may be directly compared to  $L_{eq}(1)$  in the field to determine whether the agreement criteria discussed in Section 3.3.3 are met. If more than two measurements are made, the same procedure can be used for subsequent measurements. The same reference measurement must be used throughout the procedure.

Following is an example for determining in the field whether three 15-minute measurements for different traffic conditions meet the agreement criteria in Section 3.3.3 (for convenience the measurements have been numbered consecutively regardless of setup):

**Given**

Measurement	Setup	dBA	15-Minute $L_{eq}$			Speed (mph)	Equivalent Vehicles ( $V_E$ )
			Heavy Trucks	Medium Trucks	Autos		
1	1	74.4	100	50	1,275	55	2,520
2	1	75.5	150	100	850	55	2,820
3	2	74.0	60	30	1,700	55	2,447

**Correction Calculations (Using Table 3-3)**

$$\text{Correction } c \text{ for } L_{\text{eq}}(2) = 10\log_{10}\left(\frac{V_E(1)}{V_E(2)}\right) = 10\log_{10}\left(\frac{2,520}{2,820}\right) = -0.5$$

$$L_{\text{eq}}(2N) = L_{\text{eq}}(2) + c = 75.5 - 0.5 = 75.0 \text{ dBA}$$

$$\text{Correction } c \text{ for } L_{\text{eq}}(3) = 10\log_{10}\left(\frac{2,520}{2,447}\right) = 0.2$$

$$L_{\text{eq}}(3N) = 74.0 + 0.2 = 74.1 \text{ dBA}$$

**Normalized Data Using Table 3-3**

Measurement	Setup	Normalized $L_{\text{eq}}$ (dBA)
1	1	74.4
2	1	75.0
3	2	74.1

Further examination indicates that the agreement criteria of Section 3.3.3 are met, and no further measurements are necessary. Please note that the normalized data are only used to determine agreement between measurements. The actual measurements and traffic counts may be used in later calculations as follows.

**Average Energy of Measurements**

74.5 dBA (report as 75 dBA)

**Average 15-Minute Traffic Counts**

$$\text{Mean Heavy Trucks} = \left(\frac{100 + 150 + 60}{3}\right) = 103.3$$

$$\text{Mean Medium Trucks} = \left(\frac{50 + 100 + 30}{3}\right) = 60.0$$

$$\text{Mean Autos} = \left(\frac{1275 + 850 + 1700}{3}\right) = 1,275.0$$

**Expand Average 15-Minute Traffic Counts to 1 Hour**

$$\text{Mean Heavy Trucks} = 103.3 \times 4 = 413$$

$$\text{Mean Medium Trucks} = 60.0 \times 4 = 240$$

$$\text{Mean Autos} = 1,275.0 \times 4 = 5,100$$

The expanded average traffic counts may be used in the prediction model to calculate the noise level. The result may be compared to the energy-averaged measurement. Section 4.4 explains how this comparison may be used for “calibrating” the prediction model.

An alternative more detailed approach to normalization is contained in American Association of State Highway and Transportation Officials (AASHTO) Draft Standard TP 99-12 (American Association of State Highway and Transportation Officials 2011).

### 3.3.5 Classroom Noise Measurements

These measurements meet the requirements of the California Streets and Highways Code Section 216 which is discussed in the Protocol. Under these provisions:

[t]he noise level produced by traffic on, or by construction of, a state freeway shall be measured in the classrooms, libraries, multipurpose rooms, and spaces used for pupil personnel services of a public or private elementary or secondary school if the rooms or spaces are being used for the purpose for which they were constructed and they were constructed under any of the following circumstances: ...

Section 216 lists all of these circumstances and should be consulted to determine applicability of these measurements. For convenience, the rooms mentioned above will be referred to as “classrooms” in this section.

Determining a project’s traffic noise impacts on classroom interiors under Section 216 requires taking noise measurements inside the classroom. Please note that Section 216 requires that all measurements “be made at appropriate times during regular school hours and shall not include noise from other sources that exceed the maximum permitted by law.” The noise of vehicles that exceed the maximum allowable level in the California Vehicle Code ( $L_{\max}$  of 90 dBA at 50 feet for vehicles traveling more than 45 mph) should be excluded. Because this is difficult, however, the requirement is ignored. It is customary to take outside and inside noise levels to determine building insertion loss. This information is useful when noise abatement is necessary.

If the project involves a reconstruction of an existing freeway, simultaneous traffic noise measurements may be taken inside and outside the classroom. Microphones should be placed as shown in Figures 3-4 and 3-5.

Figure 3-4 shows the preferred setup where microphone 1 (Mic. 1) should be placed outside the classroom at approximately the same distance from the freeway as the center of the classroom. Care must be taken to place the microphone far enough away from the building to avoid significant shielding by the corner of the building. This can be accomplished by maintaining at least a 70° angle between a perpendicular line to the

freeway and a line to the corner of the building. Mic. 2 should be placed in the center of the classroom.

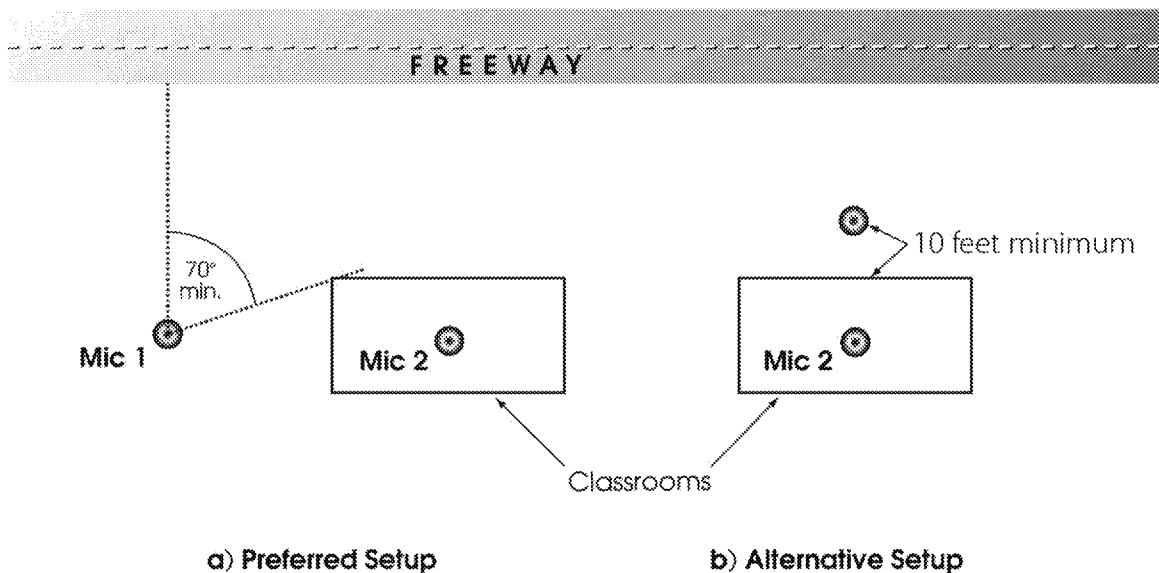

**Figure 3-4.** Classroom Noise Measurements (Reconstruction of Existing Freeway)

Figure 3-5 shows an alternate setup to be used if the setup shown in Figure 3-4 is not possible. Mic. 1 should be positioned at least 10 feet from the building to avoid noise reflections from the building. The disadvantage of this setup is that Mic. 1 and Mic. 2 are not equal distances from the freeway. If Mic. 1 is 200 feet or more from the freeway, the effects of unequal distances can usually be ignored. Assuming a 33-by-33-foot classroom, the error would be 0.5 dBA or less. Between 65 and 200 feet, a distance reduction of 1 dBA would have to be applied to Mic. 1 to normalize Mic. 1 to Mic. 2. If the distance from Mic. 1 to the freeway is less than 65 feet, a larger adjustment will be necessary. TNM may be used to calculate the adjustments.

If the classrooms are not air-conditioned and rely on open windows or doors for ventilation, simultaneous measurements should be made with doors and windows open and closed. The noise insertion loss provided by the building under these conditions is useful for predicting inside classroom noise levels and for choosing noise abatement options if needed. For instance, if a classroom interior is not expected to meet the inside classroom noise criterion with the windows and doors open, but will meet the criterion with them closed, noise abatement considered may include adding air conditioning.

If the project is on a new alignment or construction noise will be the dominant noise source, there is no existing traffic source that can be used to measure building attenuation. In that case, it is appropriate to use an artificial noise source to quantify building insertion loss (Figure 3-5).

Acceptable choices of an artificial source would be traffic noise audio recordings or an electronically generated noise spectrum that approximates typical traffic noise. This spectrum should be linear, from 31.5 to 500 Hz, and decrease at 6 dB per octave from 500 to 4,000 Hz. Amplification should be sufficient to produce A-weighted sound levels at least 10 dBA greater than background noise levels at exterior and interior microphone locations. A commercial-quality loudspeaker should be used with directional characteristics such that a 2,000-Hz signal measured at 45° from perpendicular to the face of the speaker is no more than 6 dB less than the level measured at the same distance on the perpendicular axis. The sound level output must be kept constant for inside and outside measurements.

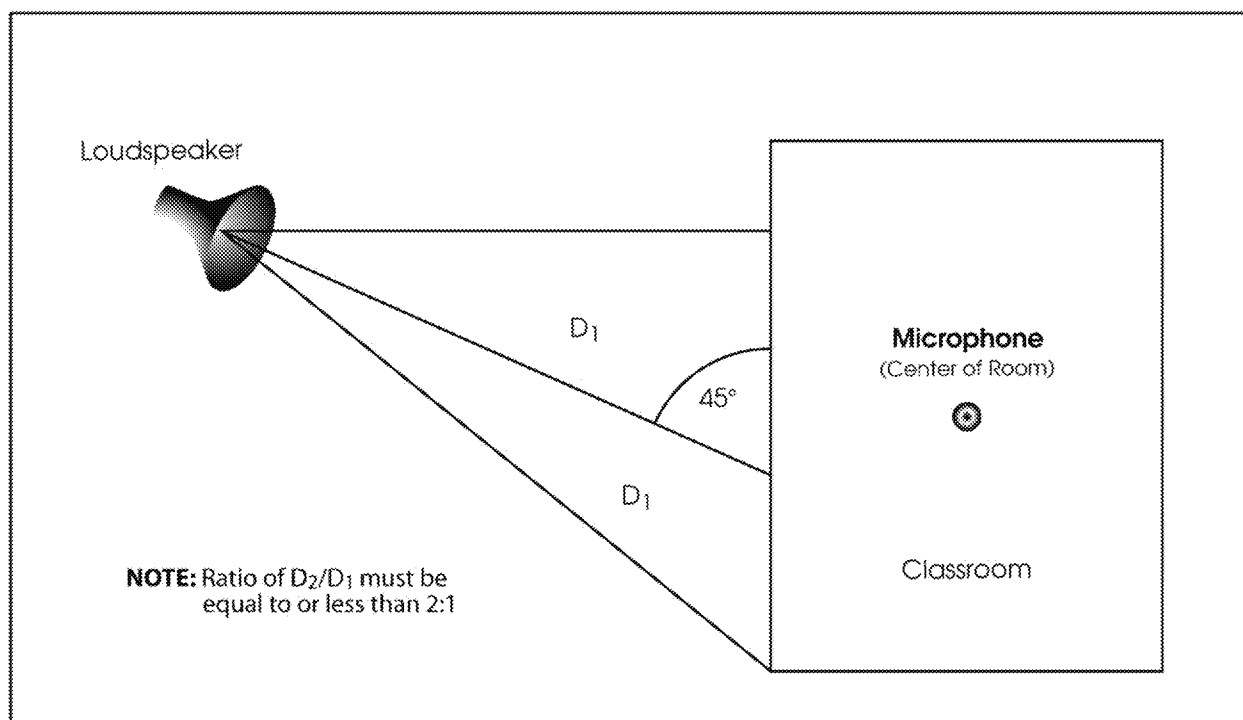

**Figure 3-5.** Classroom Noise Measurements (Project on New Alignment with Artificial Sound Source)

The loudspeaker is a point source. To account for all the possible angles of incidence provided by a line source and to avoid reflections from the building face, the speaker should be positioned as shown in Figure 3-5 for the indoor noise measurements.



Placing the speaker and microphone so that there is a direct line of sight between them through an open door or window should be avoided. If possible, additional measurements at 15°, 30°, and 60° should be taken and the results averaged. If only one angle is used, it should be 45°.

Once the indoor measurements are completed, outdoor measurements must be taken. For the outdoor noise measurements, the distance between the speaker to the outdoor microphone should be the same as the distance between the speaker and the indoor microphone. The sound level output of the artificial source must be the same for both indoor and outdoor measurements. The difference between the measured outdoor sound level and the indoor sound level indicates the sound level reduction provided by the building shell.

Section 7.4 discusses methods for evaluating interior noise for Activity Category D land use facilities (schools, hospitals, libraries, etc.). Under the 2011 revision to 23 CFR 772 interior noise abatement for residences is no longer a federally fundable form of noise abatement.

## 3.4 Instrumentation

The instruments used for measuring or recording noise include a range of manufacturers, models, types, accessories, degrees of accuracy, prices, and levels of sophistication. It is not the intent of this section to discuss all details of noise instruments or to endorse certain manufacturers. Informative catalogs are available from all major manufacturers to help in deciding what equipment to purchase, and sales representatives are usually very helpful in demonstrating the equipment. Once purchased, user manuals will be useful, ready references for specific operating procedures. It is strongly recommended that Caltrans Headquarters staff be consulted before purchasing noise instrumentation.

This section will address general features common to most instruments. The categories discussed are sound level meters, recording devices, frequency analyzers, acoustical calibrators, and meteorological and other non-noise-related equipment.

### 3.4.1 Sound Level Meters

ANSI has established requirements for sound level meter accuracy in standard ANSI S1.4-1983 (Revision of S1.4-1973) and ANSI S1.4N-1985 Amendment to ANSI S1.4-1983. The standard defines three basic types of sound level meters.

- Type 0: Laboratory Standard (primarily designed for laboratory use).
- Type 1: Precision (field use).
- Type 2: General Purpose (field use).

The expected total allowable error for a Type 1 sound level meter in the field is about 1.5 dB; for a Type 2 sound level meter in the field, the allowable error is about 2.3 dB. These expected values of total allowable errors apply to an instrument selected at random. These errors may be reduced for a specific instrument through careful calibration and adjustment.

For each sound level meter type, the standard requires three frequency weightings (A, B, and C) and two response settings (slow and fast). In addition, the standard permits other optional features in a sound level meter, such as impulse and peak measuring capabilities and wide ranges for the display of sound levels. All sound level meters used by Caltrans or its contractors shall be of any type described above (Types 0, 1, 2, with A-weighting). The type must be marked on the meter by the manufacturer. Although sound level meters are available in a variety of configurations, they all have the following general components.

- **Microphone System (Microphone and Preamplifier):** The microphone converts air pressure fluctuations into an electrical signal that is measured by instrumentation such as the sound level meter or a third-octave band spectrum analyzer. Most microphones can be detached from the body of the meter and connected to an extension cable. To satisfy a Type 0 or 1 requirement, the microphone may need to be separated from the meter body.

Microphones come in various diameters. The 0.5-inch-diameter microphone is used most commonly. The air condenser microphone (most common) consists of a membrane and back plate separated by an air gap. The width of the air gap fluctuates as the membrane vibrates in a sound field, thereby changing the capacitance. Microphones of sound level meters complying with the type standards are omni-directional, have a flat frequency response, and are sensitive over a wide range of frequencies.

A compatible preamplifier, usually manufactured as part of the microphone system, should always be used. A preamplifier provides high-input impedance and constant low-noise amplification over a wide frequency range. Depending on the type of microphone, a preamplifier may also provide a polarization voltage to the microphone.

- **Wind Screen:** A spherically or cylindrically shaped screen, generally made of open-celled polyurethane. When placed over the microphone,

it reduces wind noise (see Section 3.6). The wind screen should always be used, even in absence of wind, because it helps to protect the microphone against dust or mishaps.

- **Root Mean Square Detector:** Converts peak-to-peak signals to a rms signal. This measure is derived by squaring the signal at each instant, obtaining the average (mean) of the squared values, and taking the square root of this average.
- **Amplifier:** Amplifies the electrical signal.
- **Frequency Weighting Filters (A to C):** These filters are required by ANSI S1.4-1983 and ANSI S1.4-1985. The A-weighting is used internationally for environmental noise measurements (including transportation noise).
- **Slow or Fast Response Switch:** Refers to time-averaging characteristics of the sound level meter. On the slow setting, the averaging of sound levels takes place over 1-second increments. On the fast setting, the averaging time is 0.125 second. On a real-time display (digital or analog), the sound level fluctuations are easier to read on the slow setting. The fast setting, however, gives a better resolution of instantaneous sound levels.
- **Range Setting:** Allows setting of the correct range of sound levels to be measured.
- **Digital Display:** Displays instantaneous noise levels or integrated averages. Digital displays often have multi-function switches that allow the user to view various noise descriptors such as  $L_{eq}$  and  $L_{max}$ .
- **Battery Check Switch:** Allows user to check battery voltage.
- **Output:** For various recording devices.
- **Power On/Off Switch.**

Many sound level meters also have pause switches to interrupt data sampling, preset time switches that allow sampling over a predesignated time period, reset switches for starting a new sampling period, and other features.

## 3.4.2 Data Recording and Analysis

Professional sound level meters typically can log measured sound levels in the form of the various sound level descriptors including those described in Table 2-12. These logged values can then be downloaded to a computer for analysis using a computer spreadsheet or other analysis software.

Professional sound level meters will typically have an audio output that can be connected to an external audio recorder for recording the audio signal from the meter. Handheld solid state digital audio recorders are typically used as an external recording device. Recorders should be high-quality professional recorders with flat frequency response and high signal-to-noise ratios. Once the signal is recorded a digital signal analyzer can then be used to analyze the recorded signal using octave, one-third octave, or narrow band signal analysis equipment. Digital signal analyzers can be dedicated stand-alone units, computer software programs, or built into the sound level meter. Some sound level meters also have the ability to directly capture digital audio recordings.

### **3.4.3 Acoustical Calibrators**

Acoustical calibrators are used to calibrate the sound level meter/recorder system in the field. The calibrator fits over the top of the microphone. Care must be taken that the microphone is properly seated in the calibrator cavity. When activated, the calibrator emits an audio signal at a reference frequency and decibel level. Most calibrators have a reference level of 94 dB or 114 dB at 1,000 Hz. Modern sound level meters generally maintain calibration within about  $\pm 0.2$  dB. If field calibration values fall outside this deviation, the meter should be checked and calibrated by a laboratory accredited to perform calibrations on specified instruments.

Acoustical calibrators and sound level meters should be periodically certified for proper calibration by an appropriate certified acoustic lab.

### **3.4.4 Meteorological and Other Non-Noise-Related Equipment**

Basic meteorological data including wind speed, wind direction, temperature, and relative humidity should be collected concurrently with most noise measurements.

An anemometer is an instrument used to measure wind speed. For general-purpose measurements at relatively close distances to a noise source, i.e., within about 100 feet, a hand-held, wind-cup anemometer and an empirically observed estimation of wind direction are sufficient to document wind conditions. For all types of measurements, the anemometer should be located at a relatively exposed position and at an elevation approximately equal to that of the highest receiver position.

Other recommended equipment includes a radar gun to measure traffic speeds, tape measures, survey levels (or hand levels), and rods to survey the site and document microphone positions with reference to landmarks, as well as watches or stopwatches to time the measurements. Portable radios or cell phones may be helpful to maintain contact with traffic counting personnel and other field personnel. Traffic count logging equipment is also very useful. Traffic can be counted and classified in real time in the field or recorded with a video camera for subsequent counting and classification.

## 3.5 Noise Measurement Procedures

This section addresses general procedures for routine noise measurements. Manufacturers' manuals should be consulted for operating each specific instrument. The following procedures are common to all routine Caltrans noise measurements.

### 3.5.1 Instrumentation Setup

The sound level meter microphone should be placed 5 feet above the ground and at least 10 feet from reflecting surfaces such as buildings, walls, parked vehicles, and billboards. Operators should be careful not to shield the microphone with their bodies during the measurements. Other obstructions between microphone and noise source should be avoided unless they are representative of the region of interest.

If the microphone is not separated from the sound level meter body, the sound level meter should be supported on a tripod. If the microphone is separated, it should be placed on a tripod or other stand.

When meteorological equipment is set up, thermometers should be in the shade, and the anemometer should have good exposure to representative winds.

## 3.5.2 Field Calibration

Acoustical calibrators are described under Section 3.4.3. Some calibrators provide a choice of several frequency settings. If the calibrator offers these choices, 1,000 Hz should be used for calibration. The sound level meter/recorder system can then be adjusted to this level. The procedures in manufacturers' user manuals should be followed.

The sound level meter/recorder system should be calibrated before and after each setup. If several measurements are made during the same setup, calibration may also be checked between measurements. For routine measurements, if the reading differs by less than 0.5 dB from the reference level ( $C_R$ ) indicated on the calibrator, the sound level meter/recorder system does not need to be adjusted. If the reading deviates by 0.5 dB or more, or if measurements are part of a special study in which extreme accuracy is required, the sound level meter/recorder system should be adjusted within 0.1 dB of the reference level.

If the final calibration ( $C_F$ ) of the acoustic instrumentation differs from the initial calibration ( $C_I$ ) by 1 dB or more, all data measured with the system between the calibrations should be discarded and repeated. The instrumentation and connections should be checked thoroughly before repeating the measurements. If the final calibration is less than 1 dB from the initial calibration, all data measured with that system between the calibrations should be adjusted as follows:

$$\text{Data Adjustment} = C_R - [(C_I + C_F)/2] \quad (3-1)$$

### Example

$$C_R = 94.2 \text{ dB}$$

$$C_I = 94.4 \text{ dB}$$

$$C_F = 94.6 \text{ dB}$$

$$\text{Data Adjustment} = 94.2 - [(94.4 + 94.6)/2] = -0.3 \text{ dB}$$

All data measured in between the two calibrations should be reduced by 0.3 dB (e.g., a measurement of 66.7 dBA would become 66.4 dBA). For routine measurements, it is customary to round off and report the final adjusted value to the nearest decibel; for example, 66.4 dBA would be reported as 66 dBA, and 66.5 dBA would be reported as 67 dBA.

The field calibration procedure is described below.

1. Adequate start-up of instruments should be allowed before calibration (at least 1 minute or as specified in the manufacturer's manual). The

analyst should check that all proper connections have been made and that batteries are fresh or adequately charged.

2. The calibrator should be placed carefully over the microphone and properly seated. Touching the calibrator during calibration should be avoided.
3. If necessary make calibration adjustments as indicated in the manufacturer's user manual.

### **3.5.3 Measurements**

Following calibration of equipment, a wind screen should be placed over the microphone. The frequency weighting should be set on "A." The proper response setting should be set at "fast" or "slow." "Slow" is typically used for traffic noise measurements. The desired sampling time, sampling interval, and noise descriptor should be selected.

During the noise measurements, any noise contamination, such as barking dogs, local traffic, lawnmowers, train passbys and aircraft, should be noted. If the sound level meter is equipped with a "pause" or "standby" switch or button, the measurement should be temporarily interrupted until the noise contamination ceases. Notes on the start time and duration of the contaminating event should be taken.

Talking during measurements should be avoided. Curious bystanders will often ask the operator about the monitoring. A possible way to avoid talking near the microphone is to stand 25 to 50 feet from it, which is far enough not to contaminate the measurement but close enough to watch the setup.

If highway noise measurements are taken, traffic should be counted simultaneously with the noise measurements. At a minimum, directional traffic should be counted separately. Traffic counts by lane are best but often not practical because they are too labor-intensive. Traffic should be divided into heavy trucks, medium trucks, autos, buses, and motorcycles as defined in TNM. Definitions of these vehicle types are addressed in Section 4. Average speeds for each vehicle group and direction should be estimated using a radar gun (if available) or test runs with a vehicle in the flow of traffic during the noise measurements.

Wind speed and direction, temperature, humidity, and sky conditions (i.e., clear, partly cloudy, overcast, fog, or haze) should be observed and documented.

After the last measurement of the setup, the equipment should be recalibrated before power is turned off. Also, if the power is interrupted during or between measurements, the instruments need to be recalibrated before additional measurements are taken. The procedure for calibration and necessary data adjustment was discussed in Section 3.5.2.

### 3.5.4 Documentation

Measurement data should be carefully recorded. If the data are read from a display and hand-copied on a form, the readings should be checked and confirmed by another person if possible. It is recommended that blank data logging and collection forms be printed in advance for noise data, meteorological data, traffic counts, and site data. The forms can easily be designed for various types of measurements or specific studies using word processing or spreadsheet software. Specifically, the following items should be documented:

- **Noise Measurement Sites:** A sketch should be made showing the microphone location in relation to natural or artificial landmarks. Distances should be shown to the nearest foot to such features as building corners, trees, street signs, curbs, and fences. Enough detail should be included on the sketch to enable anyone to reoccupy, at a later date, the three-dimensional (including height above ground) position of the microphone within 1 foot horizontally and 0.5 foot vertically. Accurate three-dimensional relationships between source and site should be shown. Cross sections should be obtained from accurate maps or field surveys. Sites should be located on maps showing all receivers used in the noise analysis. Global positioning system (GPS) coordinates should be noted at each position. Photo documentation is also recommended. Many digital cameras and smart phones are capable of taking pictures that are automatically geo-tagged. The district, county, route number, and post mile of the site should be included.
- **Noise Measurements:** All instruments used for the noise measurements should be recorded, including manufacturer, model number, and serial number. Also important are the calibrator make, model, serial number, reference level, frequency, and last calibration date. Names of instrument operators and persons recording the data should be shown. Pre- and post-calibration data should be shown. Site number, date, time, length of measurement, noise descriptor, pertinent settings on the sound level meter/recorder system, and noise data should be recorded. Remarks, notes of contamination, or anything that might have a possible effect on the measurement results should be included.



- **Meteorological Conditions:** Prevailing wind direction and speed during the noise measurements, temperature, relative humidity, and sky conditions should be noted. Approximate height, and location of measurements should be indicated. Date, time, site number, and name of observer should be shown also.
- **Traffic Counts:** The number of vehicles broken down by classification should be shown. It is important to indicate the location of traffic counts, number of lanes or lane groups counted, direction, length of time, time, district, county, route, post mile, names of personnel, and counts and speeds.

Care must be taken so that enough information to make necessary cross references between noise measurements, traffic counts, weather, and site information can be made later if necessary.

## 3.6 Meteorological Constraints on Noise Measurements

Meteorological conditions can affect noise measurements in several ways. At an ambient noise level of 40 to 45 dBA, wind speeds of more than 11 mph may begin to contaminate noise measurements with a rumbling noise because of frictional forces on a microphone covered with a wind screen. Without the screen, the effect would be present at a much lower wind speed.

Extremes in temperature and relative humidity affect critical components of sound level meters. For example, during conditions of high humidity, water condensation can form on the vibrating microphone membrane, causing a “popping” sound that can contaminate noise measurements.

Rain or snow on highway pavement can alter the levels and the frequencies of tire and pavement noise, causing it to vary in unpredictable ways from levels on dry pavements, on which vehicle noise source characteristics are based. Pavement should be dry when taking measurements. Refraction caused by wind shear or temperature gradients near the ground surface will also alter noise levels. The effects of refraction are discussed in Section 2.1.4.3. When noise levels are compared to determine the effects of a transportation project on the noise environment or to evaluate the effectiveness of a noise abatement measure, the before and after noise levels should be conducted under equivalent meteorological conditions.

The following sections include listings of meteorological constraints on noise measurements and equivalent meteorological conditions.

### **3.6.1 Meteorological Criteria**

Noise measurements should not be made when one or more of the following meteorological conditions exist.

- Wind speeds are more than 11 mph for routine highway noise measurements.
- Manufacturers' recommendations for acceptable temperature and humidity ranges for instrument operation are exceeded. Typically, these ranges are from 14 to 122°F for temperature and 5 to 90% for relative humidity. Heavy fog conditions usually exceed 90% relative humidity.
- There are rain, snow, or wet pavement conditions. All reported highway noise levels are assumed valid for dry pavements only.

### **3.6.2 Equivalent Meteorological Conditions**

Wind can significantly alter noise levels. Wind effects are caused by refraction (bending) of the noise rays because of wind shear near the ground. Noise rays are bent upward upwind and downward downwind from the source, resulting in a noise decrease upwind and increase downwind from a source.

Studies by Caltrans and others have shown that this wind effect can affect noise measurements significantly even at relatively close distances to noise sources. Section 3.3.3 indicates that to compare noise measurements for agreement, all site, traffic, and meteorological conditions must be the same.

Noise measurement comparisons can therefore only be made for similar meteorological conditions. ANSI S12.8 - 1998 "Methods for Determination of Insertion Loss of Outdoor Noise Barriers" recommends that meteorological equivalence be based on wind, temperature, and cloud cover. The following criteria are recommended for atmospheric equivalence average wind velocities from the source position to the receiver position. In the case of highway noise, the wind component of interest is perpendicular to the highway. The standards recommended by ANSI may be used to define meteorological equivalency for the purposes of comparing noise levels for agreement with Section 3.3.3 or any time before and after noise measurements are performed on noise barriers.

### 3.6.2.1 Equivalent Wind Conditions

Wind conditions are equivalent for noise measurements if the following conditions exist.

- The wind class (Table 3-4) remains unchanged.
- The vector components of the average wind velocity from the source to receiver (perpendicular to the highway) do not differ by more than a certain limit.

This limit depends on the accuracy desired and the distance from the source to receiver. To keep the measurement accuracy due to atmospheric wind conditions to within about 1 dB, this limit should be 2.2 mph for distances less than 230 feet. If it is desired to keep this accuracy within about 0.5 dB for the same distance, the measurements to be compared should each be repeated at least four times. The 2.2 mph limit does not apply to the “calm” condition. By convention, the perpendicular wind component blowing from the highway to receiver (microphone position) is positive, while the same component blowing from the receiver to highway is negative.

**Table 3-4.** Classes of Wind Conditions

Wind Class	Vector Component of Wind Velocity, mph
Upwind	-2.2 to -11
Calm	-2.2 to +2.2
Downwind	+2.2 to +11

For example, two measurements may be compared when their respective wind components are 0 and -2.2 mph, -2.2 and -4.4mph, or -5.5 and -7.7 mph, but not when their respective components are 1.1 mph and 3.3 mph, because of the change in wind class. For the purposes of comparison with the results from the FHWA TNM, which has no provisions for wind inputs and therefore predicts noise levels for calm (no wind) conditions, the perpendicular wind component needs to be between -2.2 and +2.2 mph.

Please note that the actual wind velocity (direction and speed) needs to be resolved into two components, with directions parallel and perpendicular to the highway. Then, only the perpendicular component is considered (as long as the actual wind speed does not exceed 11 mph, any wind velocity may be resolved in this manner). The component of wind velocity for a given set of acoustical measurements should be determined as follows.

- Monitoring wind velocity (speed and direction) throughout any period of acoustical measurements.

- Noting the average speed and direction.
- Computing from these averages the vector component of wind velocity from the source to receiver (perpendicular to the highway).

### 3.6.2.2 Equivalent Temperature and Cloud Cover

Measurements to be compared (e.g., before or after noise barrier measurements or repeat measurements) should be made for the same class of cloud cover, as determined from Table 3-5, and with the average air temperatures within 25°F of each other.

**Table 3-5. Cloud Cover Classes**

Class	Description
1	Heavily overcast.
2	Lightly overcast, either with continuous sun or sun obscured intermittently by clouds 20 to 80% of the time.
3	Sunny, with sun essentially unobscured by clouds at least 80% of the time.
4	Clear night, with less than 50% cloud cover.
5	Overcast night, with 50% or more cloud cover.

### 3.6.2.3 Equivalent Humidity

Although there are no strict guidelines for equivalence of humidity, an attempt should be made to pair measurements for similar conditions of humidity. For example, comparisons of measurements made under extremely dry conditions (e.g., less than 25%) with those made during humid conditions (e.g., more than 75%) should be avoided.

## 3.7 Quality Assurance

All sound level meters and acoustical calibrators should be periodically calibrated by the manufacturer, or by a laboratory accredited to perform calibrations on specified instruments. All calibrations should be traceable to the National Institute of Standards and Technology (NIST) in Washington, DC. For legal purposes instrument manuals and calibration and repair records should be kept on file in the office of the responsible party (e.g., District office, headquarters environmental unit). Historical data on the instrument performance may be useful in determining the reliability and accuracy of the equipment.

## Detailed Analysis for Traffic Noise Impacts

This section discusses the procedure for conducting a detailed analysis of traffic noise impacts. These procedures comply with analysis requirements of 23 CFR 772 and are consistent with standard acoustical practices.

### 4.1 Gathering Information

The first step in a technical noise analysis is to determine the level of detail necessary for the study, which depends on the size and nature of the project. Generally, as the size of the project, the complexity of terrain, and the population density increase, so does the amount of information and level of effort needed for an adequate noise analysis.

For the analysis, it is necessary to obtain adequate information and mapping showing project alternatives and their spatial relationships to potentially noise-sensitive areas. A “no build” alternative should be included. Early in the project, final design details usually are not available, and additional analyses may need to be performed as more details are introduced. Topographical information may also be limited in early stages of project design. Field reviews, recent aerial photographs, and online geographic data may be necessary to augment information shown on preliminary maps. Design-year traffic information for all project alternatives is also required for the analysis. Traffic count data for all state highways is available for downloading from the Caltrans website at:

<http://www.dot.ca.gov/hq/traffops/saferesr/trafdata/index.htm>

### 4.2 Identifying Existing and Future Land Use and Applicable Noise Abatement Criteria

Existing and reasonably expected future activities on all lands that may be affected by noise from the highway must be identified (see the Protocol for details on how various land use types are addressed). Existing

activities, developed lands, and undeveloped lands which have been permitted for development that may be affected by noise from the highway must be identified. Land development is considered to be permitted on the date that the land use (subdivision, residences, schools, churches, hospitals, libraries, etc.) has received all final discretionary approvals from the local agency with jurisdiction, generally the date that the building permit or vesting tentative map is issued. This information is essential to determine which NAC apply for determining traffic noise impacts. The NAC are shown in Table 4-1.

**Table 4-1. Activity Categories and Noise Abatement Criteria (23 CFR 772)**

Activity Category	Activity $L_{eq}[h]^a$	Evaluation Location	Description of Activities
A	57	Exterior	Lands on which serenity and quiet are of extraordinary significance and serve an important public need and where the preservation of those qualities is essential if the area is to continue to serve its intended purpose.
B <sup>b</sup>	67	Exterior	Residential.
C <sup>b</sup>	67	Exterior	Active sport areas, amphitheatres, auditoriums, campgrounds, cemeteries, day care centers, hospitals, libraries, medical facilities, parks, picnic areas, places of worship, playgrounds, public meeting rooms, public or nonprofit institutional structures, radio studios, recording studios, recreation areas, Section 4(f) sites, schools, television studios, trails, and trail crossings.
D	52	Interior	Auditoriums, day care centers, hospitals, libraries, medical facilities, places of worship, public meeting rooms, public or nonprofit institutional structures, radio studios, recording studios, schools, and television studios.
E	72	Exterior	Hotels, motels, offices, restaurants/bars, and other developed lands, properties, or activities not included in Activity Categories A–D or F.
F			Agriculture, airports, bus yards, emergency services, industrial, logging, maintenance facilities, manufacturing, mining, rail yards, retail facilities, shipyards, utilities (water resources, water treatment, electrical), and warehousing.
G			Undeveloped lands that are not permitted for development of a specific use.

<sup>a</sup> The  $L_{eq}(h)$  activity criteria values are for impact determination only and are not design standards for noise abatement measures. All values are A-weighted decibels (dBA).

<sup>b</sup> Includes undeveloped lands permitted for this activity category.

23 CFR 772 requires that a minimum of one receiver be placed in all areas within a project area that are associated with Activity Categories A, B, C, D, and G. Undeveloped Activity Category

G areas are included because FHWA wants to provide a record of predicted future noise levels to local agencies so that these noise levels can be considered in future land use planning.

If there are no exterior use areas at an Activity Category E use it is not necessary to include a receiver in that area. Similarly, it is not necessary to include a receiver at an Activity Category F use. Receivers are not required for these areas because these uses are already developed and it is not necessary to inform local planning agencies about future noise levels in these areas.

## 4.3 Determining Existing Noise Levels

Existing noise levels may be determined at discrete locations in the project area by actual noise measurement (see Section 3) or using the TNM (see Section 4.5.1). The latter is usually the case. This section discusses how to select these locations, the methods used to determine existing noise levels, and how to “calibrate” the noise prediction model with measurements where appropriate.

### 4.3.1 Selecting Noise Receivers and Noise Measurement Sites

For the purposes of noise analysis, a noise receiver is any location included in the noise analysis. A noise measurement site is a location where noise measurements are taken to determine existing noise levels, and verify or calibrate the noise prediction model. Receivers and noise measurement sites may or may not coincide. Normally, there are more receivers than noise measurement sites. It is far less expensive to model (calculate) noise levels for receivers than to take noise measurements in the field. If the project involves the reconstruction of an existing facility, existing noise levels are measured at representative receivers and compared with modeled results for the conditions observed during the measurement. The difference between modeled and measured results may then be applied to the results for modeled future conditions. This process, called model calibration, is fully described in Section 4.4.

#### 4.3.1.1 Receptors and Receivers

In the context of a 23 CFR 772 analysis the term *receptor* means a single dwelling unit or the equivalent of a single dwelling unit. A *receiver* is a single point in a noise model that can represent one receptor or multiple receptors. Within the identified land use activity categories adjacent to the project, there are typically numerous noise receptors that need to be

analyzed for future noise impacts or benefits from noise abatement under consideration. It is not reasonable or possible to examine these factors at all receptors. Therefore, modeling receivers should be carefully selected to accurately represent one or more receptor locations. Some general recommendations for selecting receivers are listed below.

- Although noise impacts must be evaluated at all developed land uses, receiver locations should focus on areas of frequent human use (defined in the Protocol glossary).
- The TNM has been validated at distances within 500 feet of the highway. Receptors that are located beyond 500 feet from the project area do not need to be considered for analysis unless there is a reasonable expectation that noise impacts would extend beyond that boundary. This may require engineering judgment and supplemental noise measurements to determine impacts.
- Generally select receivers in locations that are receiving or are expected to receive the highest noise levels over the period covered by the analysis. Because in most cases impacts will be at receivers closest to the highway, most receivers should be in the first row of residences relative to the project alternative. Some common exceptions include the following.
  - Projects where realignment would move the noise sources toward receptors other than those adjacent to the existing alignment.
  - Projects involving geometry where the first row of homes is partially shielded and second-row homes actually may receive higher noise levels (e.g., roadways on high embankments).
  - Areas near the ends of proposed barriers where second- or third-row receptor sites may be needed to better define the barrier limits.
  - Projects that involve widening where additional right-of-way requirements may clear the first row of residences and turn the second row into the first.
- A noise measurement site should coincide with a modeling receiver whenever possible. However, this often may not be the case. The selected receiver location may not be a good or accessible location for setting up a sound level meter. In that case, a noise measurement site that is acoustically representative of the receiver should be selected in a more accessible location.
- Other noise-sensitive locations, such as libraries, churches, hospitals, and schools, should be included.
- Receivers that are acoustically equivalent of the area of concern should be chosen. The concept of acoustical equivalence incorporates equivalencies in noise sources (traffic), highway cross sections,



distance from the highway, topography of intervening terrain, shielding, and other pertinent factors. The region under study may need to be subdivided into subregions in which acoustical equivalence generally can be maintained. One or more of the previously mentioned acoustical factors should dictate boundaries of each subregion. The size of subregions may vary depending on the scope of the project.

- A minimum of two receivers should be selected for each acoustically equivalent region or subregion. The actual number necessary to define noise impacts depends not only on the type of project, but also on such influences as complexity of the highway profile and variability of the surrounding terrain. A highway with a straight grade or very shallow vertical curves in a relatively flat area with tract-type residential development that parallels the highway may need only a few receivers to adequately define the noise impacts. However, a project involving a major freeway that includes interchanges, cuts and fills in an area of rolling terrain, and non-tract mixed residential and commercial development is likely to need more receivers.
- Receivers are placed 5 feet above the ground elevation, unless dictated by unusual circumstances, special studies, or other requirements. Exceptions would include placing a receiver 5 feet above a wooden deck of a house situated on a steep slope, instead of 5 feet above the ground. Similar situations might be encountered where residential living areas are built above garages, where second-story levels would be more logical receiver locations.
- Noise should be evaluated at second-story elevations or at higher elevations in the case of multistory buildings when there are exterior areas of frequent human use at the higher elevations that could benefit from noise reduction. Examples include large patios or decks that are the primary outdoor use area in an apartment complex. Clearly, it will not be feasible or reasonable to construct a wall that protects a receiver location several stories above a freeway. There may, however, be situations where an upper story of a building is at the same elevation as the highway (i.e., the highway is on a fill section). In this case, it may be both feasible and reasonable to build a wall to reduce noise at the upper stories.
- To determine the number of benefited receptors (defined in the Protocol glossary), it is usually necessary to include receivers in the first, second, and third rows of residences (or beyond in some cases) in the noise analysis.

### 4.3.1.2 Noise Measurement Sites

The selection of noise measurement locations requires planning and foresight by the noise analyst. A fine balance should be achieved between a sufficient number of quality locations and the cost and availability of resources. Preliminary design maps, cross sections, aerial photographs, and field survey data are all helpful sources of information for selecting noise measurement sites, but the sites should be selected only after a thorough field review of the project area. Some recommended site characteristics common to all outside noise measurement sites are listed below.

- Sites should be clear of major obstructions. Reflecting surfaces such as walls of residences should be more than 10 feet from the microphone positions.
- Sites should be free of noise contamination by sources other than those of interest. Sites located near barking dogs, lawn mowers, pool pumps, air conditioners, etc. should be avoided unless it is the express intent to measure noise from these sources.
- Sites should be acoustically representative of areas and conditions of interest. They should either be located at or represent locations of frequent human use.

In addition to these general requirements, the selection of noise measurement sites is governed by the same general guidelines as those for selection of receivers in Section 4.3.1.1. Of particular importance is the concept of acoustical equivalence for representativeness of the area of concern. More detailed considerations are discussed in Section 3.2.

## 4.3.2 Measuring Existing Noise Levels

When possible, existing noise levels should be determined by field measurements. As with all field work, quality noise measurements are relatively expensive, requiring time, personnel and equipment. The noise analyst should carefully plan the locations, times, duration, and number of repetitions of the measurements before taking the measurements. Meteorological and other environmental conditions can significantly affect noise measurements. Particular attention should be given to the meteorological and environmental constraints described in the Section 3.6.

In the noise analysis for a project, the noise measurements are used to determine existing ambient and background noise levels, and to calibrate the noise prediction model when appropriate. Section 3 provides details of noise measurement methods.

### 4.3.3 Modeling Existing Noise Levels

Noise levels near existing facilities can also be determined by modeling. Although measurements are preferred, adverse environmental conditions, construction, unavailability of good measurement sites, or lack of time may make it necessary to calculate existing noise levels using TNM. However, this can only be done in areas where a defined highway source exists with minimal influence from traffic on other roads in the area or other contaminating noise sources.

Often, a combination of measurements and modeling at various receivers is used to determine existing noise levels. In addition to the measurement sites, additional receivers are modeled to establish better resolution of existing noise levels. Measurements are used in a process called model validation and calibration, which is discussed in the following section. This process can be applied to the additional modeled receivers for determining existing noise levels at a greater resolution. Model validation and calibration ensure that existing noise levels at the measured and modeled receptors are in reasonable agreement.

## 4.4 Validating/Calibrating the Prediction Model

The main purpose of modeling is to predict future noise levels. The computer model (TNM) and procedures used to predict future noise levels are discussed in Section 4.5. However, as mentioned in Section 4.3, TNM also can be used for modeling existing noise levels where measurements are not possible or undesirable because of lack of access or local environmental conditions. In both cases, the model should be validated with measurements and calibrated if necessary. This section, which discusses the model validation/calibration procedures that rely on measurements and modeling, should be used with Section 4.5. However, for convenience, all information needed except for running the model is contained in this section.

TNM cannot account for all the variables present in the real world. It uses relatively simple algorithms to approximate physical processes that are complex in nature. TNM for projects involving existing roadways should always be validated for accuracy by comparing measured sound levels to modeled sound levels using traffic data collected during the measurement. If modeled sound levels do not match measured sound levels within  $\pm 3$  dB the model parameters should be reviewed and adjusted if necessary to ensure that they accurately represent actual site conditions. If the measurements and model results are still not in agreement, the model should be calibrated.

This section discusses the model calibration process. Section 4.4.1 addresses model calibrations that are routinely performed by Caltrans. The procedures for these are straightforward but rely on sound judgment and place a heavy burden on quality noise measurements.

## 4.4.1 Routine Model Calibration

### 4.4.1.1 Introduction

The purpose of model calibration is to fine-tune the prediction model to actual site conditions that are not adequately accounted for by the model. In general, model calibrations are recommended if the site conditions, highway alignment, and profile in the design year relative to existing conditions are not expected to change significantly.

Model calibration is defined as the process of adjusting calculated future noise levels by algebraically adding a calibration constant derived from the difference between measured and calculated noise levels at representative sites. The difference—calibration constant,  $K$ -constant, or  $K$ —is defined as measured noise level  $M$  minus calculated noise level  $C$ , or  $K = M - C$ . Please note that  $K$  is positive when  $M$  is greater than  $C$ , and  $K$  is negative when  $M$  is less than  $C$ . In this section, a distinction will be made between calculated and predicted noise levels as follows:

- Calculated noise levels (existing or future) are the results of the model.
- Predicted noise levels are adjusted or calibrated calculated values.

### 4.4.1.2 Limitations

Highways constructed along new alignments and profiles do not lend themselves to model calibration. The site before project construction does not include the new highway. Ambient noise levels are generated by typical community noise sources, such as lawn mowers, air conditioners, and barking dogs, which cannot be modeled with TNM.

Highway reconstruction projects that significantly alter alignments and profiles of an existing highway are also poor candidates for model calibration. However, predictions of future noise levels for simple highway widening projects, design of retrofit noise barriers, or other improvements that do not significantly change highway alignment or profile are good candidates for model calibration as long as other site conditions do not change.

### 4.4.1.3 Pertinent Site Conditions

To determine whether the model can be calibrated successfully, the site conditions that are allowed to change between the present and the expected life of the project should be examined first. For this purpose, site conditions should be divided into two groups:

- **Group 1:** Site conditions that can be accounted for by the model, which include the following.
  - Traffic mix, speeds, and volumes.
  - Noise dropoff rates, terrain conditions, ground types, and distances.
  - Opaque barriers (noise transmission through barrier material may be ignored [i.e., high transmission loss]).
  - Roadway and barrier segment adjustments.
  - Receptor locations.
  - Grade corrections.
  - Pavement type.

Note that FHWA policy requires the use of the “average” pavement type for design year traffic noise predictions. Alternative pavement types such as dense-graded asphaltic concrete (DGAC), Portland cement concrete (PCC), and open-graded asphaltic concrete (OGAC) can be used in the model validation process if actual existing pavements are one of these types of alternative pavements.

- **Group 2:** Site conditions that cannot be accounted for by the model and therefore are ignored, although they affect the local noise environment. These include the following.
  - Non-typical vehicle noise populations such as farm equipment, recreational vehicles, or vehicles with studded snow tires or aggressive tread (i.e., designed for mud and snow conditions).
  - Transparent shielding (noise transmission through material is significant [i.e., low transmission loss], and such materials include wood fences with shrinkage gaps [noise leaks] and areas of heavy brush or trees).
  - Reflections off nearby buildings and structures.
  - Meteorological conditions.

For the purposes of model validation and calibration, Group 1 site conditions are allowed to change somewhat. The degree to which conditions can change is a judgment call and is discussed further in

Section 4.4.1.5. Group 2 site conditions, however, are not allowed to change. These conditions affect noise levels to an unknown extent but are ignored by the model. As long as they remain constant during the entire analysis period, they may be corrected for with  $K$ . If they change at some point in the future, however,  $K$  also must change by an unknown amount, and model calibration becomes invalid.

Some cautions and challenges associated with Groups 1 and 2 site conditions are discussed in Section 4.4.1.5. First, however, the calibration procedures will be explained.

#### 4.4.1.4 Procedures

The actual mechanics of model calibration are fairly straightforward.

1. Select locations along the existing highway that are representative of the area of interest.
2. Take noise measurements at these locations and count traffic, preferably during the peak noise hour. If this is not possible, select any other time during which traffic mix and speeds (not necessarily volumes) are roughly similar to the noisiest time. This may be estimated. Typically, this condition occurs during daytime whenever traffic is free-flowing.
3. Calculate the noise levels with the prediction model using the traffic counts (expanded to 1 hour), site geometry, and any other pertinent existing features.
4. Compare measured and calculated noise levels. If these values differ by more than 3 dB check traffic data and model parameters to ensure they represent actual site conditions. If the values continue to differ by more than 3 dB then calibrate the model using the difference. The difference,  $K$ , is determined as follows:

$$K = \text{Measured} - \text{Calculated}, \text{ or } K = M - C \quad (4-1)$$

Add  $K$  to the future calculated noise levels to obtain predicted noise levels  $P$ :

$$P = C + K \quad (4-2)$$

The following illustrates the mechanics of the calibration procedure with some typical values.

**Example**

<u>Existing Noise Levels (<math>L_{eq}[h]</math>, dBA)</u>	<u>Future Noise Levels (<math>L_{eq}[h]</math>, dBA)</u>
73 ( $C_1$ )	75 ( $C_2$ )
70 (M)	? ( $P_1$ )

$$K = M - C_1 = 70 - 73 = -3 \text{ dBA}$$

$$P_1 = C_2 + K = 75 + (-3) = 72 \text{ dBA}$$

The predicted future noise level is 72 dBA. In essence, although the model calculated the future noise level to be 75 dBA, it is expected that the actual future noise level will be 72 dBA, possibly because of the inability of the model to account for existing obstacles or other site features that attenuate noise.

#### 4.4.1.5 Cautions and Challenges

Section 4.4.1.3 indicated that Group 1 conditions (those conditions that can be accounted for in the model) are allowed to vary. Experience has shown that significant changes in traffic volumes, speeds, and mix, as well as shielding by barriers more than 6 feet high and segment adjustments within the range normally encountered, can be accounted for adequately by the model. The main problem areas in Group 1 site conditions pertaining to model calibrations are differences in source-to-receiver distances and low barriers.

First, distances should be considered. No model can satisfy all conditions encountered in the real world. Therefore,  $K$  tends to be at least somewhat distance-dependent. This has two major implications for the calibration process.

- Source-to-receiver distances, their relative heights, and the groundcover between them should not change significantly during the analysis period. Slight changes in distances (e.g., from widening projects) or even slight changes in profile or receiver height are permissible. Also, the differences between ground effects before and after construction of a noise barrier appear to be adequate in the model.
- Receivers need to be selected for several representative distances to include the effects of propagation inaccuracies in  $K$ . Each receiver may have a different  $K$ . The user must decide on their radius of influence and whether to group some  $K$ 's together (if they are close enough). This is clearly a matter of judgment based on experience.

The second Group 1 challenge relates to attenuation from low ground features or barriers. Although it is Caltrans' policy to build barriers that are at least 6 feet high, it is possible that the existing condition includes a low rise in terrain, a hinge point, or a low barrier. Because these features will result in some degree of attenuation, it is important to include these low ground features or barriers in the model if calibration is going to be conducted. Meteorology is one of the major challenges in Group 2 site conditions. The effects of wind speed and direction or temperature inversions on noise levels at a receiver can be substantial, even at relatively short distances from a highway. (Refer to Section 2.1.4.3 for more details on these effects.) Because the prediction model does not take weather into consideration, noise measurements should be taken under calm wind conditions. Strong temperature inversion conditions should be avoided as well. Temperature inversion conditions can occur during warm summer and fall months with cool morning conditions. Section 3.6 discussed the criteria for identifying calm winds. Any attempt to calibrate the model for a prevailing wind condition is only valid for that condition. Noise standards, however, are not linked to weather.

Finally, noise contamination from other sources not considered by the model cannot be corrected by model calibration, as illustrated in the following hypothetical case. In this case, at a calibration site, the existing measured noise level is 68 dBA. This freeway noise level is contaminated by nearby surface streets and other neighborhood noises and the freeway contribution and background noise cannot be separated from the measurement. It is not known that the freeway traffic and background noise contribute 65 dBA each, for a total of 68 dBA. The existing noise level from the freeway was calculated to be 65 dBA, which happens to agree with the actual freeway contribution. There is no reason to believe that the background noise will change in the future. Therefore, the model is incorrectly calibrated. The calculated future noise level is 70 dBA. However, the predicted future level must be determined. This problem is outlined below.

#### **Existing Noise Levels**

Freeway: 65 dBA (unknown)  
 Background: 65 dBA (unknown)  
 Total: 68 dBA (measured)  
 Freeway: 65 dBA (calculated)  
 $K = M - C = 68 - 65 = 3$

#### **Future Noise Levels**

Freeway: 70 dBA (unknown)  
 Background: 65 dBA (unknown)  
 Total: 71 dBA (actual)  
 Freeway: 70 dBA (calculated)  
 Freeway: ? dBA (predicted)

#### **Predicted Freeway**

$$P = C + K = 70 + 3 = 73 \text{ dBA}$$

(Compared with 71 dBA actual)



In this situation, the calibration process caused an overprediction of 2 dBA, although the background remained the same during the analysis period. Therefore, background noise high enough to contaminate the noise measurements cannot be considered a Group 1 or 2 site condition. In short, it represents a site condition that precludes the use of model calibration.

Noise measurement sites should be carefully selected to eliminate as many Group 2 site conditions as possible and to avoid any contamination. Contamination occurs when the sound level of an undesired noise source is within 10 dBA of the noise source of interest. A quick check for contamination can be performed by viewing the instantaneous sound level on a sound level meter. If the meter responds at all to fluctuations of the undesired source, the noise level likely will be contaminated.

#### **4.4.1.6 Tolerances**

Model accuracy is usually sufficient when the difference between measured and model sound levels is less than 3 dB. Because of the inherent uncertainties in the measurements and calibration procedures, model calibration should not be attempted when calculated and measured noise levels agree within 1 dBA. If there is great confidence in the accuracy and representativeness of the measurements, calibration may be attempted when calculated noise levels are within 2 dBA of the measured values. Differences of 3 to 4 dBA may routinely be calibrated unless the validity of the measurements is in serious doubt. Differences of 5 dBA or more should be approached with caution. The analyst should retake measurements, look for obvious causes for the differences (e.g., weather, pavement conditions, obstructions, reflections), check traffic and other model input parameters (and remember to expand traffic counted during the noise measurement to 1 hour), and confirm that the traffic speeds are accurate. If differences of 5 dBA or more still exist after confirming the measurements and input parameters, the decision about whether to calibrate the model should be made after determining whether any of the responsible Group 2 site conditions will change during the project life.

#### **4.4.1.7 Common Dilemmas**

The following hypothetical cases present some common dilemmas the noise analyst may need to resolve when selecting model calibration sites. In one case, a receiver was selected in a backyard abutting a freeway right-of-way. The only obstacle between the receiver and the freeway is a 6-foot-high wood fence running parallel to the freeway. The fence boards are standard ½ - by 6-inch boards with shrinkage gaps between them. The

question is whether this receiver should be used for model calibration measurements.

There is no clear-cut answer. If the fence is new and expected to remain in good condition for about the next 20 years and no noise barrier is planned, this probably would be a good representative location to measure existing noise levels and predict model-calibrated future noise levels for all the backyards bordering the right-of-way.

In another case, the predicted (calibrated) noise level at this receiver is high enough to qualify for a noise wall. Before the wall is constructed, the existing fence provides transparent shielding, a Group 2 site condition. After the wall is constructed, however, any effect from the fence will be eliminated, regardless of whether the fence remains (i.e., the effects of a Group 2 site condition change). In this case, the location would be a bad choice for model calibration.

In many cases, it is uncertain whether noise levels are high enough to justify noise barriers until the noise is measured. There are also no assurances of the longevity of wooden backyard fences. In the preceding case (and for wooden privacy fences in general), it is good policy to pick for calibration purposes locations on the freeway side of the fence or on a side street that dead-ends at the freeway right-of-way. Similar situations may exist in areas of heavy shrubs or dense woods.

Shielding by a solid barrier such as by a masonry block wall of at least 6 feet in height, can be adequately addressed by the model and does not represent a problem in the calibration process.

## 4.5 Predicting Future Noise Levels

After determining the existing noise levels, future noise levels are predicted for all project alternatives under study for the analysis period. This information is needed to determine whether any of the alternatives are predicted to result in traffic noise impacts. The traffic noise prediction procedures are specified in 23 CFR 772. FHWA requires that all new project noise studies be evaluated using the federally approved TNM. An exception to this requirement may occur for a reevaluation noise study of a project that was originally analyzed using an earlier noise model. Any decision to use an earlier noise model should be reviewed and approved by Caltrans headquarters noise staff. Refer to the 2009 version of TeNS for a detailed discussion of previous noise models.

## 4.5.1 FHWA TNM Overview

The FHWA TNM was released on March 30, 1998. FHWA mandated that all new federal-aid highway projects that begin after January 15, 2006, be evaluated using TNM. TNM Version 2.5 is the current version as of the publishing of this document. *Federal Highway Administration Traffic Noise Model* and *FHWA TNM* are a registered copyright and trademark. This provides FHWA with the exclusive right to use these names. The copyright and trademark encompass the user's guide, technical manual, software source, and executable codes.

The following sections provide a brief overview of TNM. For detailed information, the technical manual and user's guide should be consulted. Refer to the following FHWA website for current information and guidance on TNM:

[http://www.fhwa.dot.gov/environment/noise/traffic\\_noise\\_model/tnm\\_v25](http://www.fhwa.dot.gov/environment/noise/traffic_noise_model/tnm_v25)

Additional detailed technical guidance from FHWA is available at the following website:

[http://www.fhwa.dot.gov/environment/noise/regulations\\_and\\_guidance/](http://www.fhwa.dot.gov/environment/noise/regulations_and_guidance/)

### 4.5.1.1 TNM Reference Energy Mean Emission Levels

TNM computes highway traffic noise at nearby receivers and aids in the design of noise barriers. The noise sources include an entirely new database of 1994–1995 REMELs that is detailed in *Development of National Reference Energy Mean Emission Levels for the FHWA Traffic Noise Model (FHWA TNM), Version 1.0* (Fleming et al. 1995). The database includes speed-dependent emission levels for constant speeds on level roadways from idle to 80 mph, for the following vehicle types.

- **Automobiles:** all vehicles having two axels and four tires—designated primarily for transportation of nine or fewer passengers, i.e., automobiles, or for transportation of cargo, i.e., light trucks. Generally with gross vehicle weight less than 9,900 pounds.
- **Medium Trucks:** all cargo vehicles with two axles and six tires—generally gross vehicle weight is greater than 9,900 pounds but less than 26,400 pounds.
- **Heavy Trucks:** all cargo vehicles with three or more axles—generally with gross vehicle weight greater than 26,400 pounds.

- **Buses:** all vehicles having two or three axles and designed for transportation of nine or more passengers.
- **Motorcycles:** all vehicles with two or three tires with an open-air driver/passenger compartment.

TNM contains the following pavement types.

- DGAC.
- PCC.
- OGAC.
- Average: a combination of both DGAC and PCC pavements which is comprised of, on average, approximately 75% DGAC pavement and 25% PCC pavement.

TNM defaults to *average* for pavement type. The use of any other pavement type must be substantiated and approved by FHWA. Therefore, unless definite knowledge is available on the pavement type and condition and its noise-generating characteristics, no adjustments should be made for pavement type in the prediction of highway traffic noise levels.

In addition, the database includes data for the following.

- Vehicles on grades.
- Three different pavements (DGAC, OGAC, and PCC).
- Accelerating vehicles.
- Acoustic energy apportioned to two subsurface heights above the pavement (0 feet and 5 feet for all vehicles, except for heavy trucks, where the subsurface heights are 0 feet and 12 feet).
- Data stored in one-third-octave bands.

The TNM Baseline REMEL curves shown in Figure 4-1 were plotted from the following TNM Baseline equations:

$$\text{Speed} = 0 \text{ (idle): } L(s_i) = 10\log_{10}(10^{C/10}) \quad (4-3)$$

$$L(s_i) = C \quad (4-4)$$

$$\text{Speed} > 0: L(s_i) = 10\log_{10}[(0.6214s_i)^{A/10} + 10^{B/10} + 10^{C/10}] \quad (4-5)$$

Where:

$L(s_i)$  = REMEL for vehicle type  $i$  at speed  $s$  in kilometers per hour

$s_i$  = speed of vehicle type  $i$  in kilometers per hour

A, B, C are constants for each vehicle type, shown below (Table 4-2)

Note: For speeds in miles per hour omit 0.6214 in Equation 4-5.

**Table 4-2. TNM Constants for Vehicle Types**

Vehicle Type	Constants		
	A	B	C
Autos	41.740807	1.148546	50.128316
Medium trucks (two axles, dual wheels)	33.918713	20.591046	68.002978
Heavy trucks (three axles)	35.879850	21.019665	74.298135

Note: Baseline REMELs = REMELs for the following conditions.

- Average pavement (average for all pavements in the study, including PCC, DGAC, and OGAC).
- Level roadways (grades of 1.5% or less).
- Constant-flow traffic.
- A-weighted, total noise level at 50 feet.

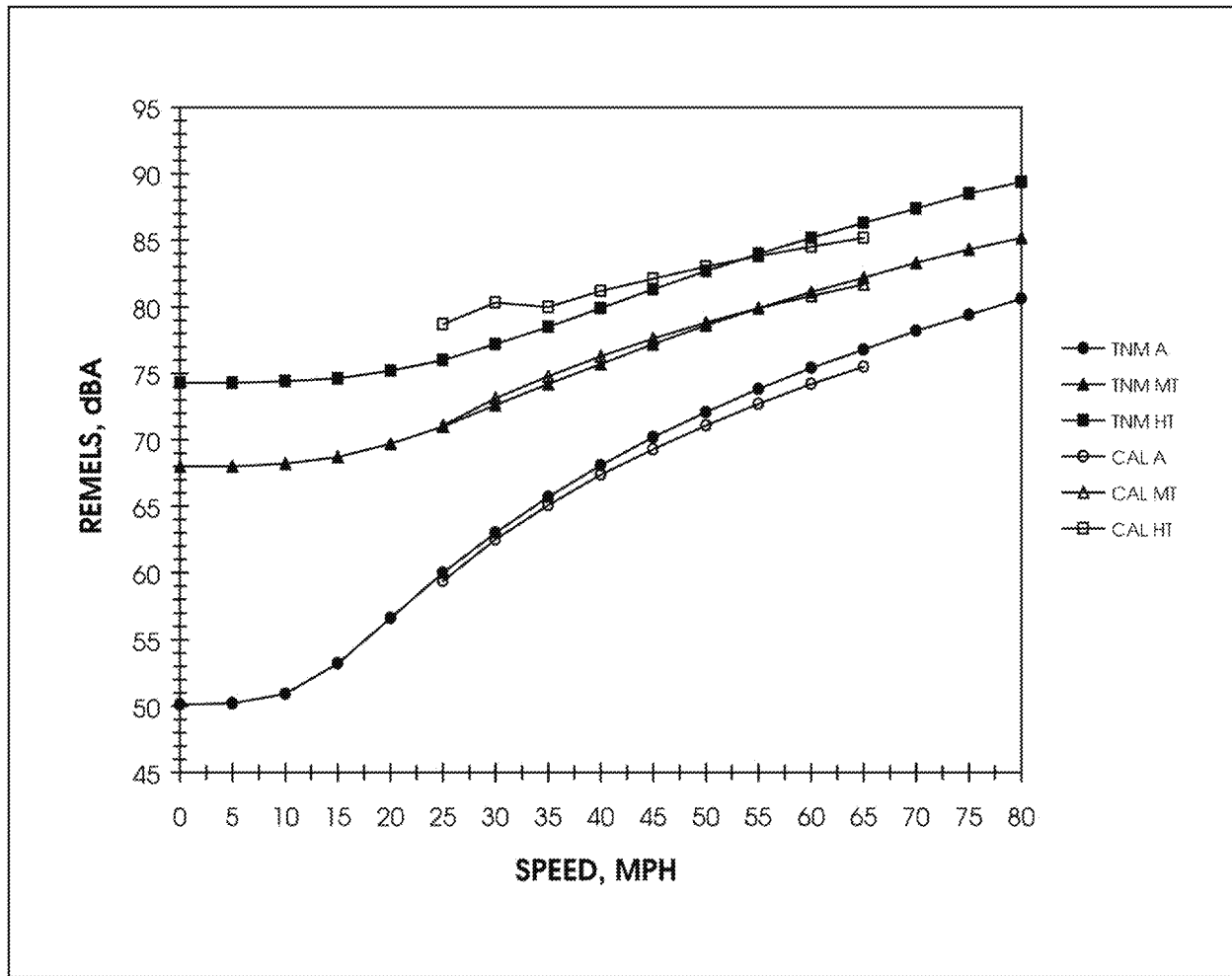

Figure 4-1. A-Weighted Baseline FHWA TNM REMEL Curves

### 4.5.1.2 Noise Level Computations

TNM calculations of noise levels include the following components.

- Three noise descriptors ( $L_{eq}[h]$ ,  $L_{dn}$ , and  $CNEL$ —see Section 2.2.2.2).
- Capability of inserting traffic control devices, including traffic signals, stop signs, tollbooths, and on-ramp start points (the TNM calculates vehicle speeds and emission levels, and noise levels accordingly).
- Computations performed in one-third-octave bands for greater accuracy (not visible to users).
- Noise contours if specified.

Roadways and roadway segments define noise source locations (x-y-z coordinates). Hourly traffic volumes determine the noise characteristics of the source.

### 4.5.1.3 Propagation, Shielding, and Ground Effects

The TNM incorporates sound propagation and shielding (e.g., noise barriers) algorithms, which are based on research of sound propagation over different ground types, atmospheric absorption, and shielding effects of noise barriers (including earth berms), ground, buildings, and trees. However, the TNM does not include the effects of atmospheric refraction, such as varying wind speed and direction or temperature gradients. TNM propagation algorithms assume neutral atmospheric conditions (zero wind speed, isothermal atmosphere). The propagation algorithms can use the following user input information.

- Terrain lines (x-y-z coordinates) define ground location. Source and receiver heights above the ground are important in noise propagation.
- Ground zones (x-y-z coordinates) define perimeters of selected ground types. Ground type may be selected from: a ground-type menu (e.g., lawn, field grass, pavement), specified default, or user input flow resistivity (if known).
- Berms may be defined with user-selectable heights, top widths, and side slopes. They are computed as if they are terrain lines.
- Rows of buildings (x-y-z coordinates) with percentage of area shielded relative to the roadways may be input to calculate additional attenuation.
- Tree zones (x-y-z coordinates) may be included for additional attenuation calculations if appropriate.

The propagation algorithms also include double diffraction. The net diffraction effect is computed from the most effective pair of barriers, berms, or ground points that intercept the source-to-receiver line of sight.

### 4.5.1.4 Parallel Barrier Analysis

TNM calculates the noise reduction provided by a barrier placed between a roadway and a receiver. If another barrier is placed on the opposite side of the roadway there is potential for multiple reflections between the two barriers to degrade the noise reduction provided by the original barrier at the receiver. (See Section 5.1.7.4 for a detailed discussion of this issue.)

TNM cannot directly calculate the degradation in barrier performance caused by parallel barriers. There is however a separate two-dimensional module in the program that can calculate the degradation caused by multiple reflections at a single receiver for a given parallel barrier configuration. This degradation, expressed in dB, is then applied to the TNM model results for that receiver.

## 4.6 Comparing Results with Appropriate Criteria

After the predicted noise levels (including model calibration, if appropriate) have been determined, they should be compared with the appropriate impact criteria in the Protocol. Examination of traffic noise impacts includes comparing the following for each project alternative when appropriate.

- Predicted noise levels with existing noise levels (for “substantial increase” impacts).
- Predicted noise levels with the appropriate NAC (for “approach or exceed” impacts).
- Predicted noise level of classroom interior with 52 dBA- $L_{\text{eq}}(\text{h})$  (as required by California Street and Highways code).

## 4.7 Evaluating Noise Abatement Options

If traffic noise impacts have been identified, noise abatement must be considered. Noise abatement measures may include those listed in the Protocol. These potential measures are based on avoiding impacts, interrupting noise paths, or protecting selected receptors. If the project alternative locations are flexible, alignments and profiles can be selected to avoid sensitive receptors or reduce the noise impacts. Most often, highway alignments and profiles are selected based on other overriding factors. The construction of noise barriers is usually the most common noise abatement option available. The consideration of noise abatement described in the Protocol requires at a minimum a preliminary design of the abatement. Section 5 provides guidance on the design considerations of noise barriers.



## Noise Barrier Design Considerations

The primary function of highway noise barriers is to shield receivers from excessive noise generated by highway traffic. Although there are other strategies for attenuating transportation-related noise, noise barriers are the most common noise attenuation option used by Caltrans.

Many factors need to be considered in the proper design of noise barriers. First, barriers must be acoustically adequate. They must reduce the noise as described by policies or standards. Acoustical design considerations include barrier material, locations, dimensions, shapes, and background noise levels. Acoustical considerations, however, are not the only factors leading to proper design of noise barriers.

A second set of design considerations, collectively labeled non-acoustical design considerations, is equally important. Noise barriers can have secondary effects related to security in surrounding areas, aesthetics, community continuity, and other non-acoustical factors. With appropriate planning and design these potential effects from noise barriers can be reduced or avoided.

The current edition of the *Highway Design Manual* Chapter 1100 should be consulted for specific noise barrier design criteria. Because these may change in the future, the discussion in this section will focus on general applications and consequences of the design criteria, not on the criteria themselves. The Caltrans Headquarters Division of Environmental Analysis should be consulted for the latest status.

The acoustical and non-acoustical design considerations in this section conform to the *FHWA Highway Noise Barrier Design Handbook* (Fleming et al. 2011).

### 5.1 Acoustical Design Considerations

The FHWA TNM described in Section 4 is used for determining proper heights and lengths of noise barriers. The models assume that the noise

barriers do not transmit any sound through the barrier. Only the noise diffracted by the barrier and any unshielded segments are considered. Therefore, the material of the barrier must be sufficiently dense or thick to ensure that the sound transmission through the barrier will not contribute to the total noise level calculated by the model at the receiver.

The material, location, dimensions, and shape of a noise barrier all affect its acoustical performance. The various effects associated with these factors are discussed in Sections 2 and 4.5.

Figure 5-1 is a simplified sketch showing what happens to vehicle noise when a noise barrier is placed between the source and receiver. The original straight path from the source to receiver is now interrupted by the barrier. Depending on the barrier material and surface treatment, a portion of the original noise energy is reflected or scattered back toward the source. Another portion is absorbed by the material of the barrier, and another is transmitted through the barrier. The reflected (scattered) and absorbed noise paths never reach the receiver.

The transmitted noise continues on to the receiver with a loss of acoustical energy (redirected and some converted into heat). The common logarithm of energy ratios of the noise in front of the barrier and behind the barrier, expressed in decibels, is the TL. The TL of a barrier depends on the barrier material, primarily its weight, and the frequency spectrum of the noise source.

The transmitted noise is not the only noise from the source reaching the receiver. The straight line noise path from the source to the top of the barrier, originally destined in the direction of "A" without the barrier, now is diffracted downward toward the receiver (Figure 5-2). This process also results in a loss of acoustical energy.

Therefore, the receiver is exposed to both the transmitted and diffracted noise. Whereas the transmitted noise only depends on barrier material properties, the diffracted noise depends on the location, shape, and dimensions of the barrier. These factors will be discussed in the following sections.

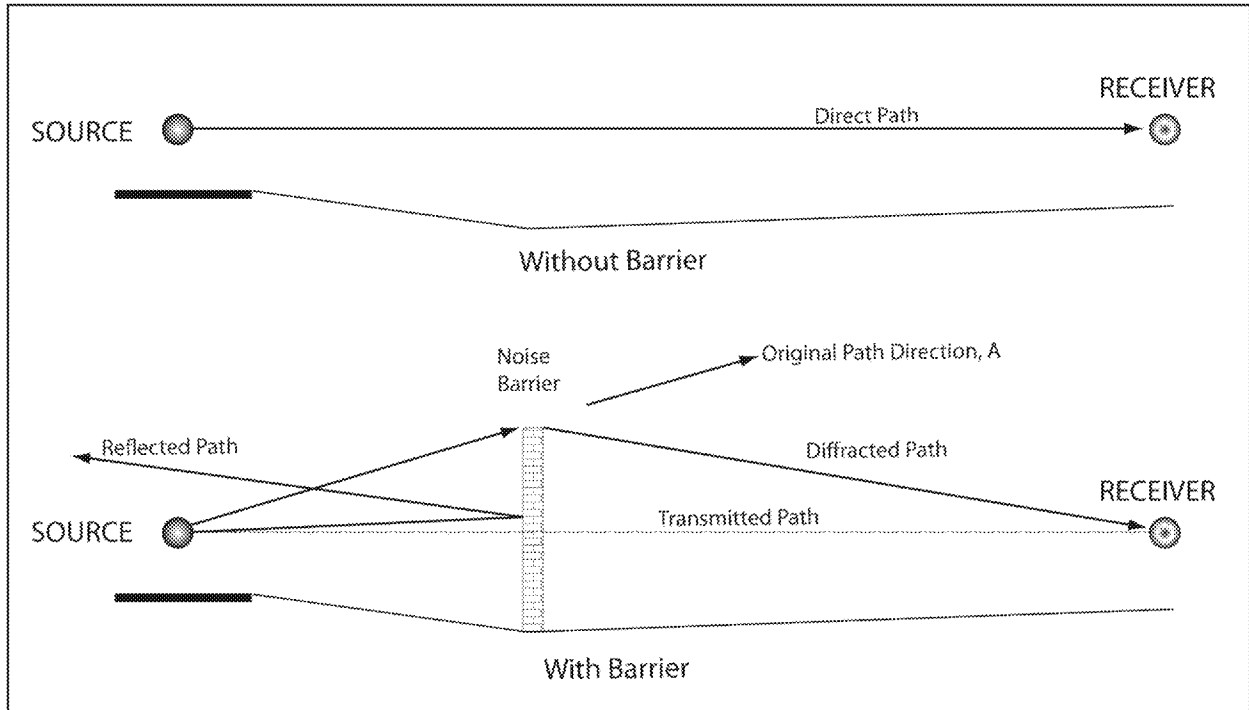

**Figure 5-1.** Alteration of Noise Paths by a Noise Barrier

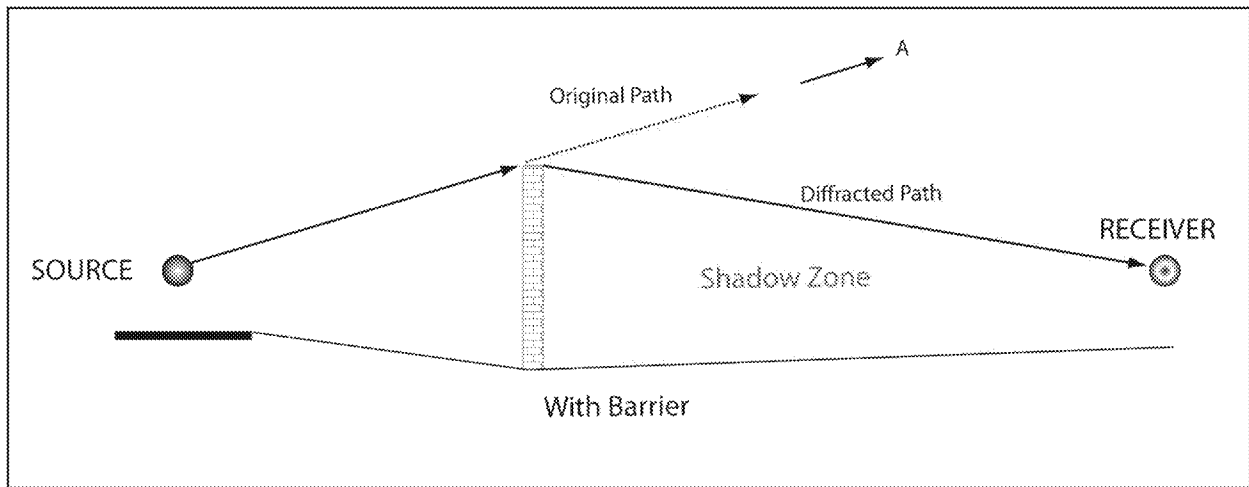

**Figure 5-2.** Barrier Diffraction

### 5.1.1 Barrier Material and Transmission Loss

For acoustical purposes, any material may be used for a barrier between a noise source and a noise receiver as long as it has a TL of at least 10 dBA more than the desired noise reduction. This ensures that the only noise path to be considered in the acoustical design of a noise barrier is the

diffracted noise path. For example, if a noise barrier is designed to reduce the noise level at a receiver by 8 dBA, the TL of the barrier must be at least 18 dBA. The transmitted noise may then be ignored because the diffracted noise is at least 10 dBA more.

As a general rule, any material weighing 4 pounds per square foot or more has a transmission loss of at least 20 dBA. Such material would be adequate for a noise reduction of at least 10 dBA due to diffraction. Please note that this weight can be attained by a variety of material types. The denser a material is, the thinner it may be. TL also depends on the stiffness of the barrier material and frequency of the source.

In general the maximum noise reduction that can be achieved from a barrier is about 20 dBA for thin screens (walls) and 23 dBA for berms. Therefore, a material that has a TL of 33 dBA (23 + 10) or more would be adequate for a noise barrier in most situations.

Table 5-1 gives approximate TL values for some common materials, tested for typical A-weighted traffic frequency spectra. They may be used as a rough guide in acoustical design of noise barriers. For accurate values, material test reports by accredited laboratories should be consulted. These product specifications can usually be provided by the manufacturer.

**Table 5-1. Approximate Transmission Loss Values for Common Materials**

Material	Thickness (Inches)	Weight (Pounds per Square Foot)	Transmission Loss (dBA)
Concrete block, 8 by 8 by 16 inches, light weight	8	31	34
Dense concrete	4	50	40
Light concrete	6	50	39
Light concrete	4	33	36
Steel, 18 gage	0.050	2.00	25
Steel, 20 gage	0.0375	1.50	22
Steel, 22 gage	0.0312	1.25	20
Steel, 24 gage	0.025	1.00	18
Aluminum, sheet	0.0625	0.9	23
Aluminum, sheet	0.125	1.8	25
Aluminum, sheet	0.25	3.5	27
Wood, fir	0.5	1.7	18
Wood, fir	1	3.3	21
Wood, fir	2	6.7	24

Material	Thickness (Inches)	Weight (Pounds per Square Foot)	Transmission Loss (dBA)
Plywood	0.5	1.7	20
Plywood	1	3.3	23
Glass, safety	0.125	1.6	22
Plexiglas	0.25	1.5	22

Table 5-1 assumes no openings or gaps in the barrier material. However, some materials such as wood are prone to develop openings or gaps because of shrinkage, warping, splitting, or weathering. These openings decrease the TL values. The TL of a barrier material with openings can be calculated if the ratio of area of openings to total barrier area and TL of the material are known. The following formula can be used to calculate the transmission loss with the openings ( $TL_o$ ):

$$TL_o = TL - 10\log_{10}(A_o * 10^{TL/10} + A_c) \quad (5-1)$$

Where:

$TL_o$  = transmission loss of material with openings

TL = transmission loss of material without openings

$A_o$  = area of openings as a fraction of the total area of the barrier

$A_c$  = area of closed portion as a fraction of the total area of the barrier =  $1 - A_o$

This method of calculation assumes that the openings or gaps are distributed uniformly over the surface of a barrier. For example, a barrier made of 2-inch-thick fir planks has openings that make up about 5% of the total area and are about equally distributed. The transmission loss of the material with these gaps can then be determined. From Table 5-1, the TL for 2-inch fir is 24 dBA.  $A_o$  is 5%, or 0.05;  $A_c$  is  $1 - 0.05 = 0.95$ .

Therefore:

$$TL_o = 24 - 10\log_{10}(0.05 * 10^{2.4} + 0.95) = \mathbf{12.7, \text{ or about } 13 \text{ dBA}}$$

The reduced TL could affect the barrier's performance. For example, it is assumed that before the barrier the noise level was 75 dBA and the intention was to reduce noise levels by 10 dBA (i.e., the diffracted noise was to be 65 dBA, and the transmitted noise was to be  $75 - 24 = 51$  dBA). The total noise level would have been  $65 + 51 = 65$  dBA. With the gaps, however, the transmitted noise is now  $75 - 13 = 62$  dBA, and the total noise level is  $65 + 62 = 66.8$  dBA. The effectiveness of the barrier is reduced by almost 2 dBA. Instead of a designed noise reduction of 10 dBA, an actual noise reduction of only 8 dBA will be realized in this case.

Properly treated materials will reduce or eliminate noise leakage. For example, lumber should be treated with preservatives that provide proper penetration and do not interfere with any protective coatings (e.g., paint) to be applied later. The wood also should have a low moisture content, requiring kiln drying after waterborne preservatives have been used. Wood planks should have tongue-and-groove deep enough to allow for shrinkage without gaps to maintain a high TL. Such tongue-and-groove is usually non-standard.

Several other ratings are used to express the ability of materials in specific construction configurations to resist sound transmission. Two of these are the Sound Transmission Class (STC) and Exterior Wall Noise Rating (EWNR). Both are most often used in conjunction with indoor acoustics.

STC is universally accepted by architects and engineers. The rating uses a standard contour against which the TL values in one-third-octave bands are compared in the frequency range between 125 and 4,000 Hz. The standard contour is moved up or down relative to the test curve until the sum of the differences between them is 32 dB or less, and the maximum difference at each one-third-octave center frequency is no more than 8 dB. The STC is the TL value of the standard contour at the 500-Hz center frequency.

The disadvantage of this rating scheme is that it is designed to rate noise reductions in frequencies of normal office and speech noises, not for the lower frequencies of highway traffic noise. The STC can still be used as a rough guide, but it should be pointed out that for frequencies of average traffic conditions, the STC is 5 to 10 dBA more than the TL. For example, material with an STC rating of 35 has a TL of about 25 to 30 dBA for traffic noise.

The EWNR rating scheme is different from the STC in that it uses a standard contour developed from typical highway noise frequencies. Therefore, it agrees closely with the A-weighted TL for traffic noise. The *FHWA Highway Traffic Noise: Analysis and Abatement Guidance* (Federal Highway Administration 2011) provides further useful information for calculating outdoor to indoor traffic noise reductions.

## 5.1.2 Barrier Location

The previous section indicated that by selecting materials with sufficient TL, noise transmitted through a barrier may be ignored because its contribution to the total noise level is negligible. The only remaining noise of concern is diffracted noise. Sections 2 and 4 discuss the basics of diffraction and barrier attenuation. The principal factor determining barrier

attenuation is the Fresnel number, which is related to the path length difference (PLD) between the original straight line path between the source and receiver (source–receiver) and the diffracted path, described by the source, to top of the barrier, to the receiver (source–top of barrier–receiver). The greater this difference, the greater the barrier attenuation, to a limit of 20 dB for walls and 23 dB for berms. Figure 5-3 shows the PLD concept.

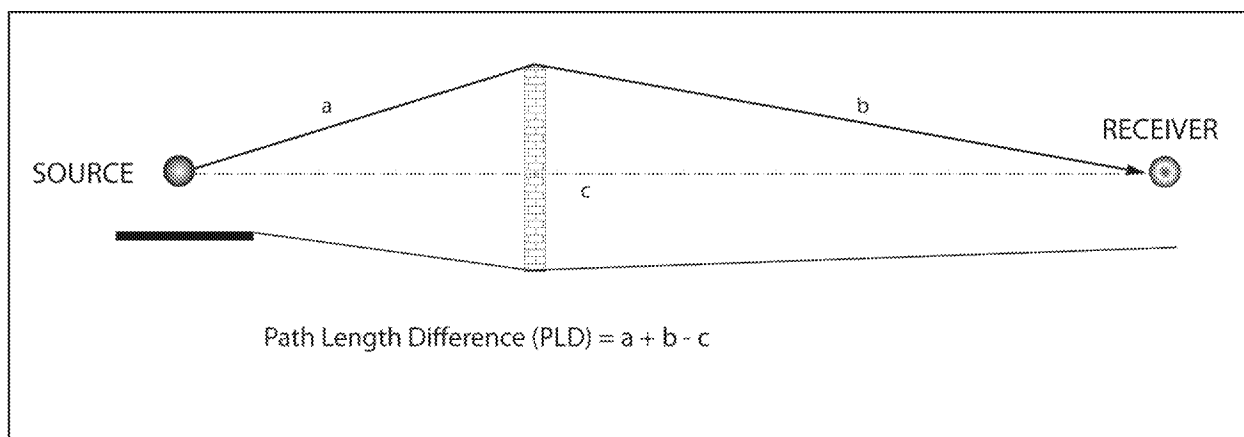

**Figure 5-3.** Path Length Difference

In level, at-grade roadway-receiver cross sections, a noise barrier of a given height provides greater barrier attenuation when it is placed either close to the source or close to the receiver. The least effective location would be about halfway between the source and receiver. Figure 5-4 shows these situations for two source heights (autos and heavy trucks). Location *b* gives the lowest barrier attenuations for a given barrier height.

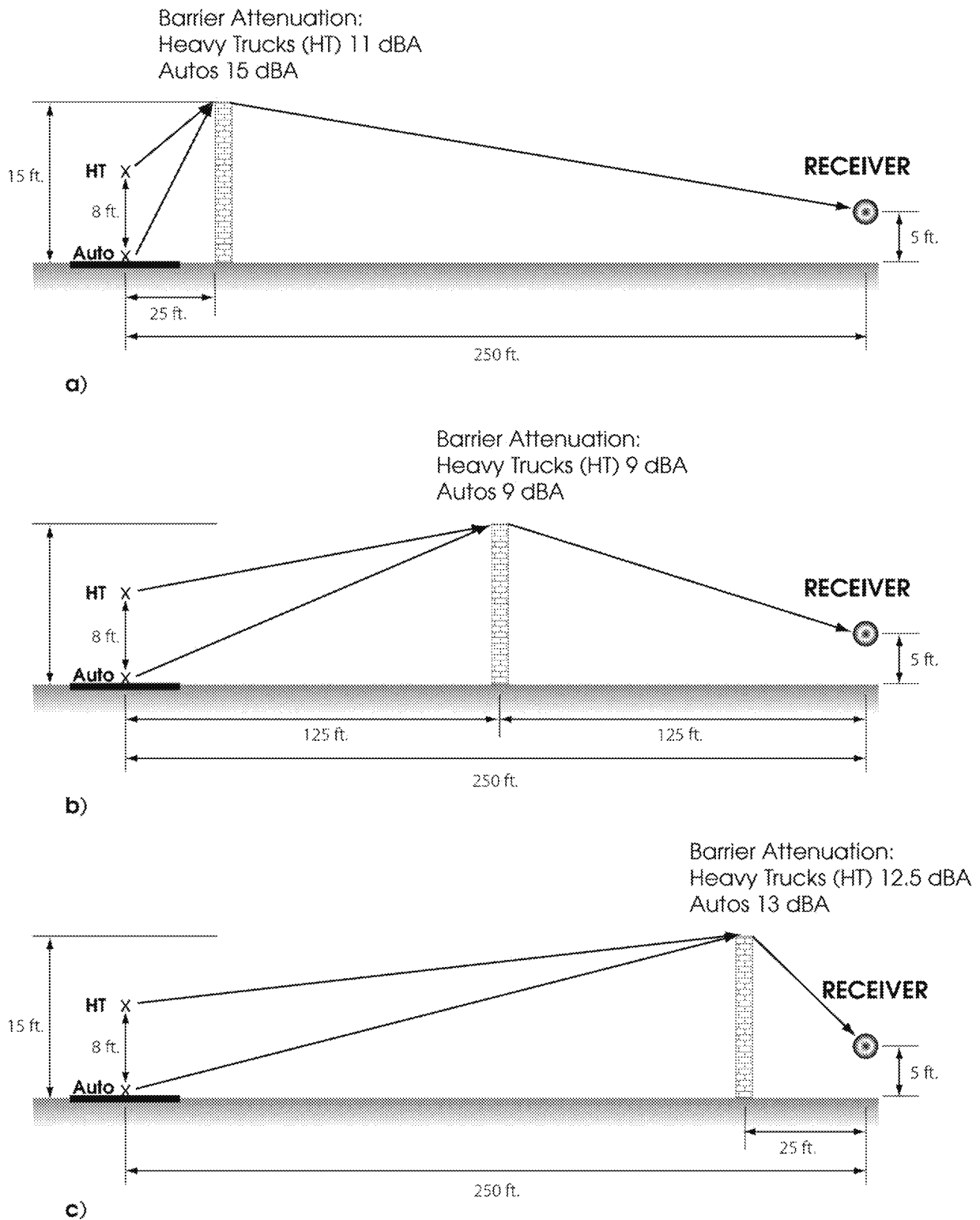

**Figure 5-4.** Barrier Attenuation as a Function of Location (At-Grade Highway)—Barrier Attenuation is Least When Barrier is Located Halfway between the Source and Receiver *b*; the Best Locations are Near the Source *a* or Receiver *c*



In depressed highway sections, the barrier is most effective near the receiver on top of the cut (Figure 5-5). Please note that the without-barrier path is generally not a straight path between the source and receiver. The top of cut is already a fairly effective noise barrier. The PLD in this case is the difference between the paths described by source–top of barrier–receiver line, and source–top of cut–receiver line. The barrier attenuation is then calculated from the difference in barrier attenuation provided by the top of cut and top of the noise barrier.

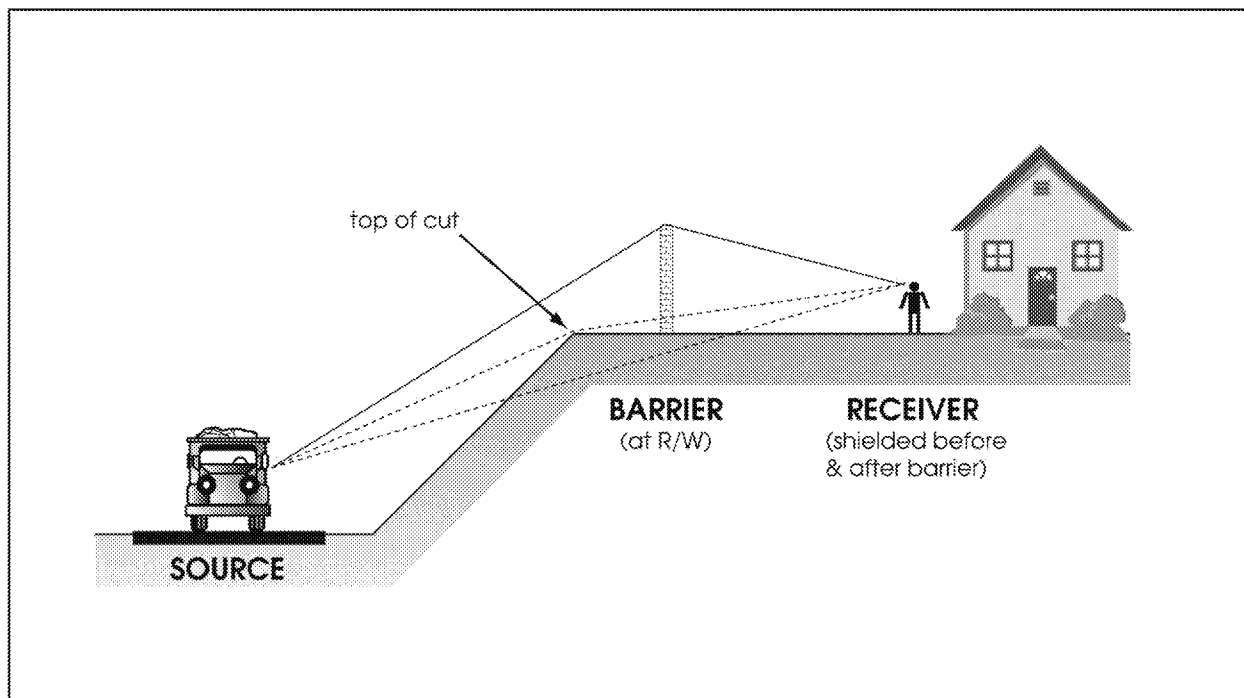

**Figure 5-5.** Typical Barrier Location for Depressed Highways

Because the attenuation per incremental increase in barrier height diminishes with the effective height of a barrier (see Section 5.1.3), this difference may be small. Noise barriers at the top of depressed highway sections are generally not very effective in reducing noise because the top-of-cut of the cut section by itself may already be providing substantial noise reduction.

The most effective location of noise barriers along highways on fills is on top of the embankment (Figure 5-6). Any attempt to place the barrier closer to the receivers will result in a higher barrier for the same or less attenuation. The same is true for elevated highways on structures. The most effective barrier location from an acoustical standpoint is on top of the structure.

The preceding discussions point out that the most acoustically effective location for a noise barrier depends on the source-to-receiver geometry. In most cases, the choices are fairly obvious. To recap the simplest situations:

- **Highway at Grade:** barrier location near the edge of shoulder or at the right-of-way (barrier is close to the noise source).
- **Highway in Depressed Section:** barrier at the right-of-way (barrier is close to the receiver).
- **Elevated Highway on Embankment or Structure:** barrier near edge of shoulder (barrier is close to the noise source).

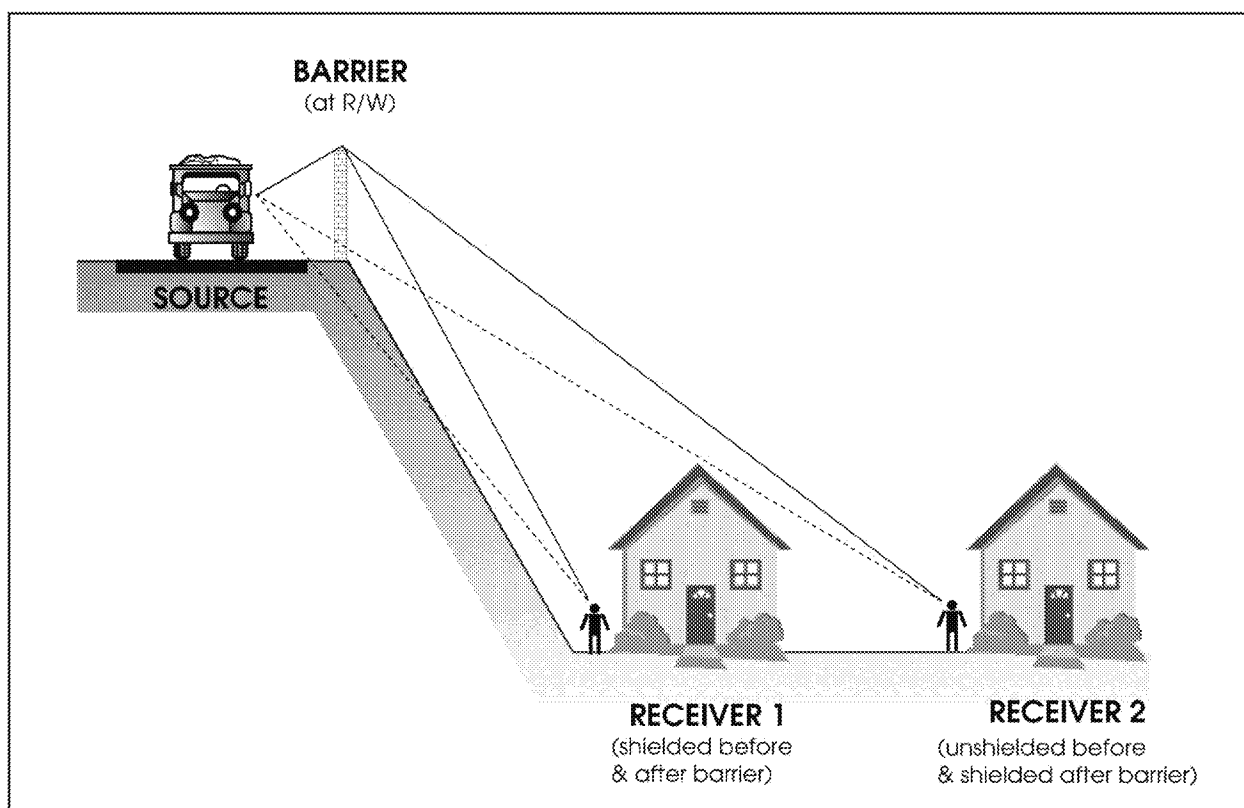

**Figure 5-6.** Typical Barrier Location for Elevated Highways

In some cases, however, the choices are not as simple. In more complex highway/receiver geometries, the best locations from an acoustical standpoint may need to be determined by using TNM for several barrier location alternatives.

Transitions between cuts and fills, ramps, and interchanges are some examples of cases that need careful consideration. Figures 5-7 to 5-9 show typical noise barrier locations in some of these transitional areas. Barrier overlaps are often necessary in these cases (Figures 5-7 and 5-8).

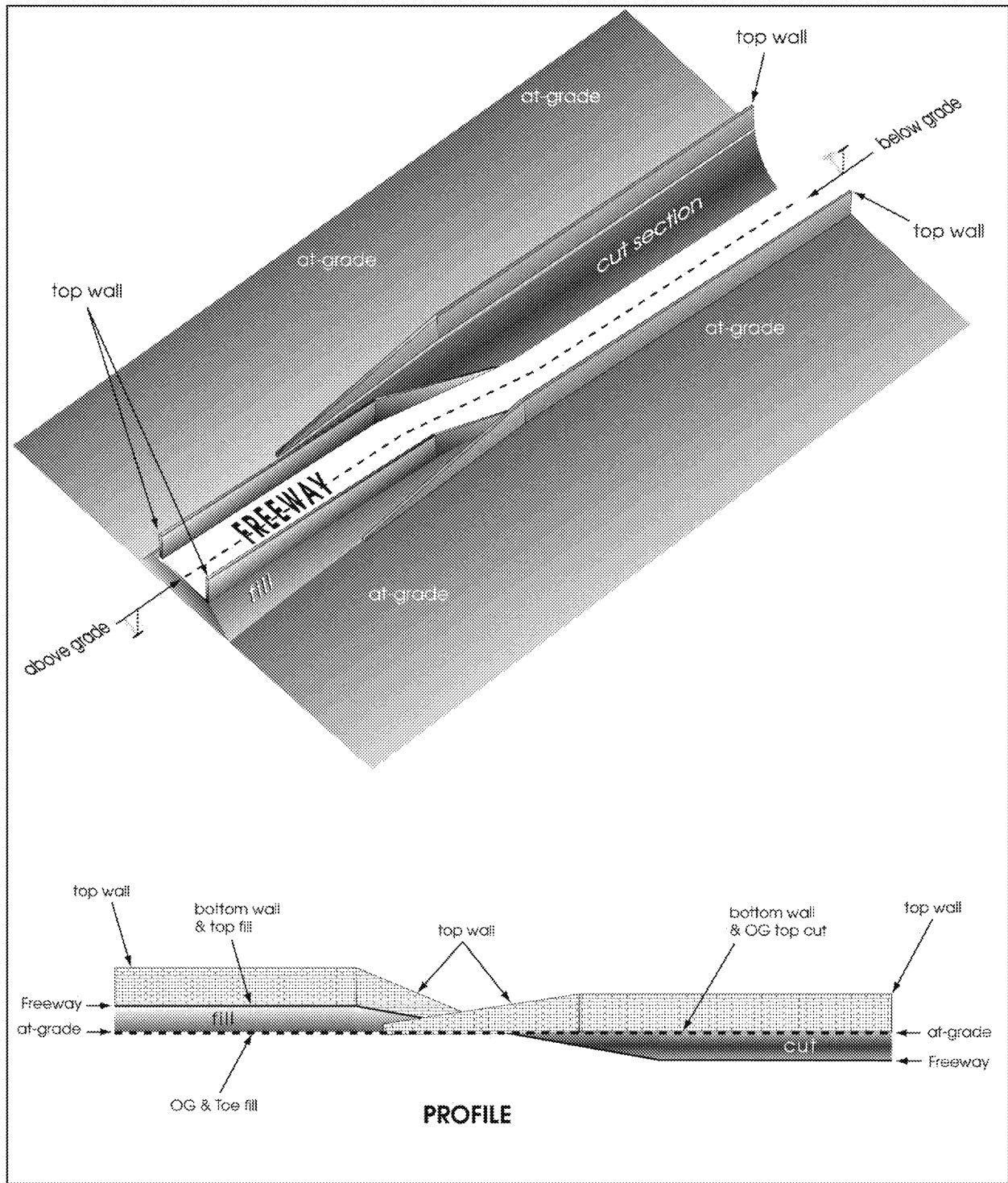

**Figure 5-7. Barriers for Cut and Fill Transitions**

One of the more common reasons for barrier overlaps is to provide maintenance access to the areas within the right-of-way that are on the

receiver side of noise barriers (Figure 5-7). This will be discussed in more detail in the maintenance consideration portion of this section.

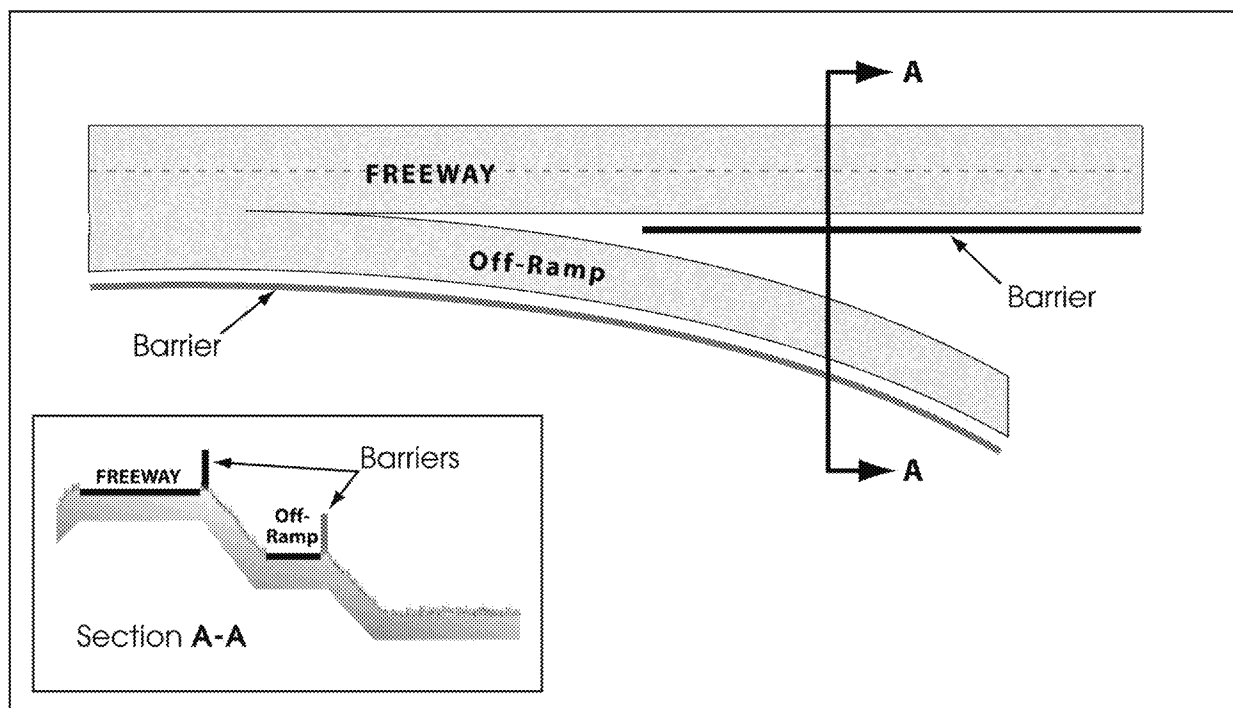

**Figure 5-8.** Barriers for Highway on Fill with Off-Ramp

Restrictions on lateral clearances, sight distances, and other safety considerations may also dictate final noise barrier locations. The current version of the Caltrans *Highway Design Manual* should always be consulted before finalizing alternate noise barrier alignments.

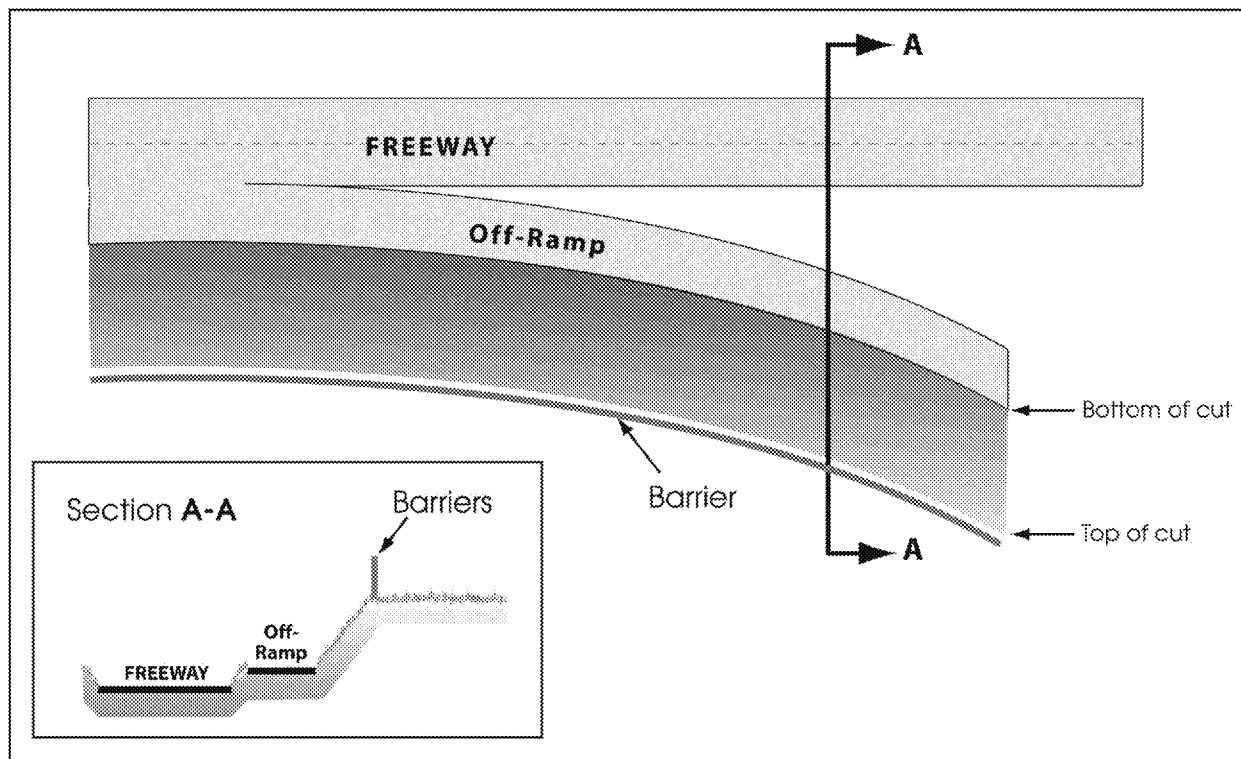
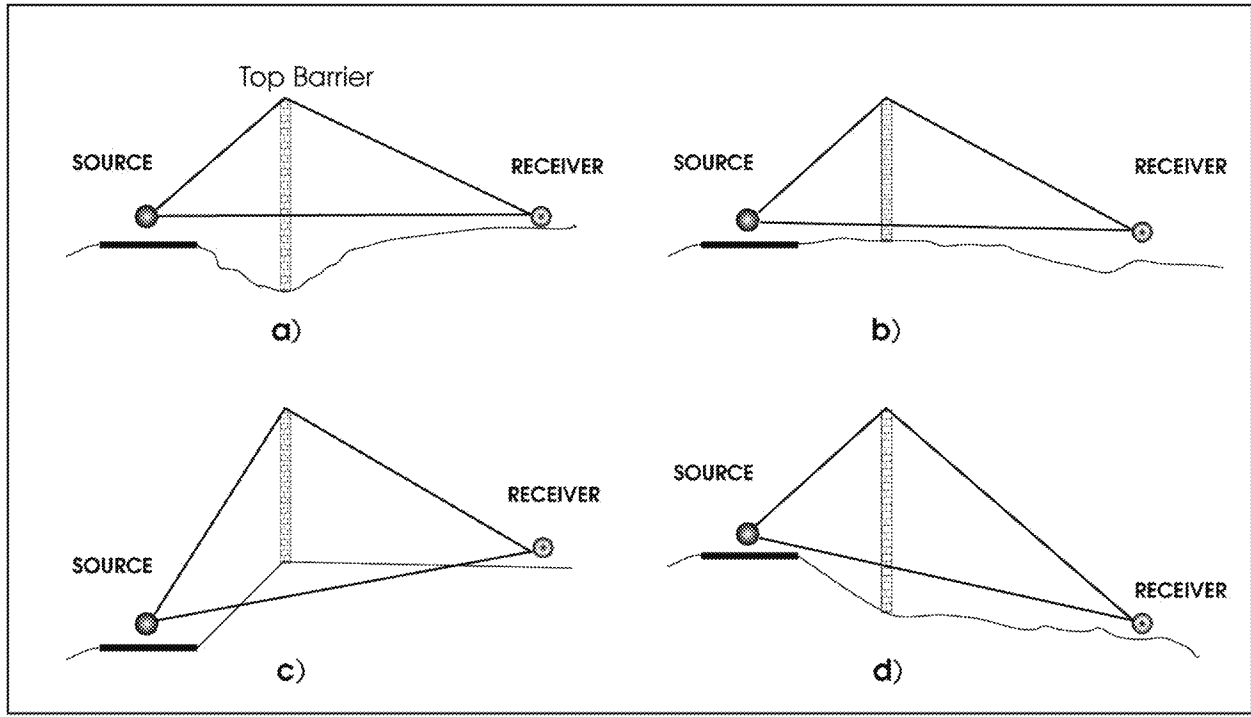

Figure 5-9. Barriers for Highway in Cut with Off-Ramp

### 5.1.3 Barrier Dimensions

Noise barrier dimensions depend largely on the freeway geometry, topography of the surrounding terrain, location of the noise barrier, and size of the area to be shielded by the barrier. Barrier attenuation depends on the path length difference between the direct (before-barrier) and diffracted (after-barrier) noise paths. Figure 5-3 reviews the concept. Because the location of the bottom of the barrier is not part of the triangle, the highway geometry and terrain topography determine how high the barrier should be for a given barrier attenuation. Figure 5-10 illustrates this concept.

Similarly, the length of the barrier is governed by the extent of the area to be shielded and the site geometry and topography (Figure 5-11).



**Figure 5-10.** Actual Noise Barrier Height Depends on Site Geometry and Terrain Topography (Same Barrier Attenuation for a, b, c, and d)

**PLAN VIEW**

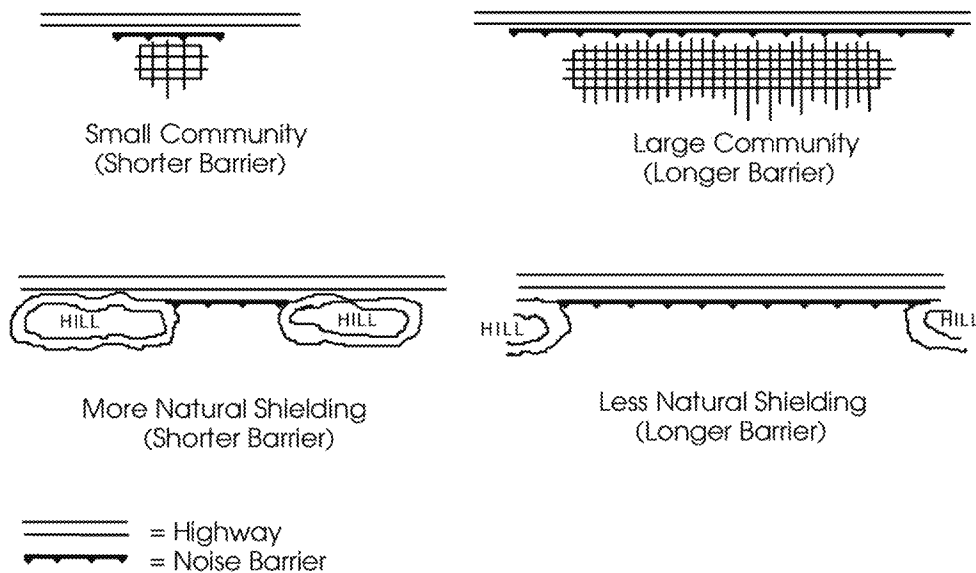

**Figure 5-11.** Noise Barrier Length Depends on Size of the Area to be Shielded and Site Geometry and Topography

### 5.1.3.1 Height

Barrier height generally has the most direct influence on the effectiveness of a noise barrier. Figure 5-3 reviews the PLD concept. An increase in height of a noise barrier will result in a greater PLD and therefore greater noise attenuation. This increase in noise attenuation is not linear with the increase in height.

Figure 5-12 shows the barrier attenuation as a function of wall height at a 5-foot-high receiver, 50 feet behind a soundwall located along the right-of-way of a typical urban at-grade eight-lane freeway. The traffic consists of 10% heavy trucks, 5% medium trucks, and 85% autos. Attenuations are plotted for wall heights from 6 to 16 feet, representing minimum and maximum heights identified in the Caltrans *Highway Design Manual* Chapter 1100. Also shown is the height at which the line of sight between an 11.5-foot truck stack and a 5-foot-high receiver is intercepted by the wall. For this particular highway/barrier/receiver geometry, the intercept height is 9 feet and the associated attenuation is 7.5 dB.

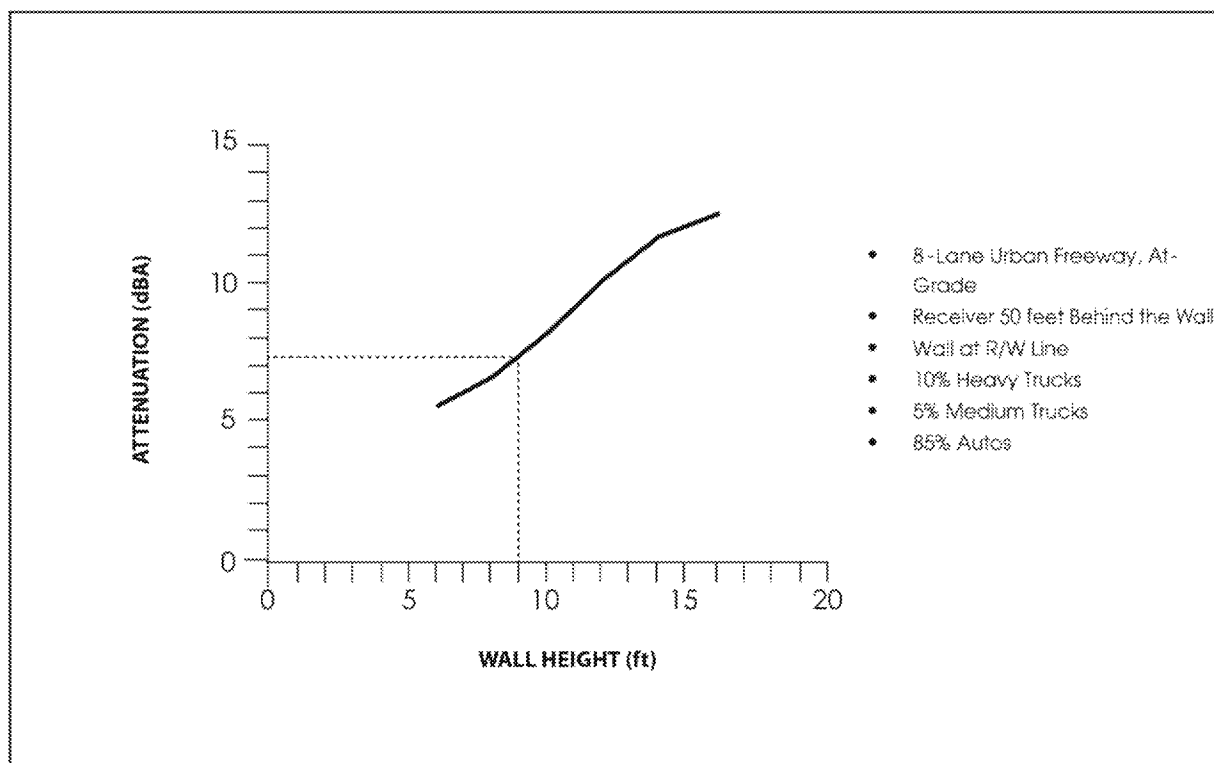

Figure 5-12. Soundwall Attenuation vs. Height for At-Grade Freeway

Please note that in this case the change in attenuation per incremental change in wall height is highest between wall heights of 9 and 11 feet, at 0.9 dBA per 1 foot. Above and below this range, the values are lower.

Once the optimum height has been reached, any further increases in noise barrier height results in diminishing returns in effectiveness. Higher barriers are often necessary to meet design goals.

Noise barriers along depressed freeways are less effective than those along at-grade freeways. In deep cuts, the receiver often is already effectively shielded by the tops of cuts. In some cases, this top-of-cut shielding may not reduce noise levels enough to satisfy barrier design criteria, and an additional barrier behind the top of cut may be necessary to achieve further noise reductions.

When designing such a barrier, the designer should recognize that the without-barrier or before-barrier condition includes the shielding of the existing top of cut. Because of the diminishing-returns effect, a barrier of a given height along a depressed freeway will generally be less effective than a barrier of the same height in an at-grade situation. The diminishing-returns effect, however, is not the only factor to consider.

In general a berm is more effective in reducing noise than a wall of the same height because of additional diffraction, ground absorption, and path length effects. The top of cut associated with a depressed freeway essentially acts like a berm in terms of noise attenuation. Figure 5-13 shows the barrier attenuation vs. height plots for a receiver 50 feet behind a barrier located on the right-of-way of a typical urban eight-lane freeway in a 25-foot-deep depressed section. The traffic mix is the same as that for Figure 5-12, described above. Two attenuation curves are shown.

The upper curve represents attenuation differences between a wall (after-construction condition) and the top of cut (before-construction condition) in which the latter is treated as an existing wall. Such a condition would exist if a soundwall were built on top of an existing retaining wall (i.e., the top of cut would be the top of retaining wall).



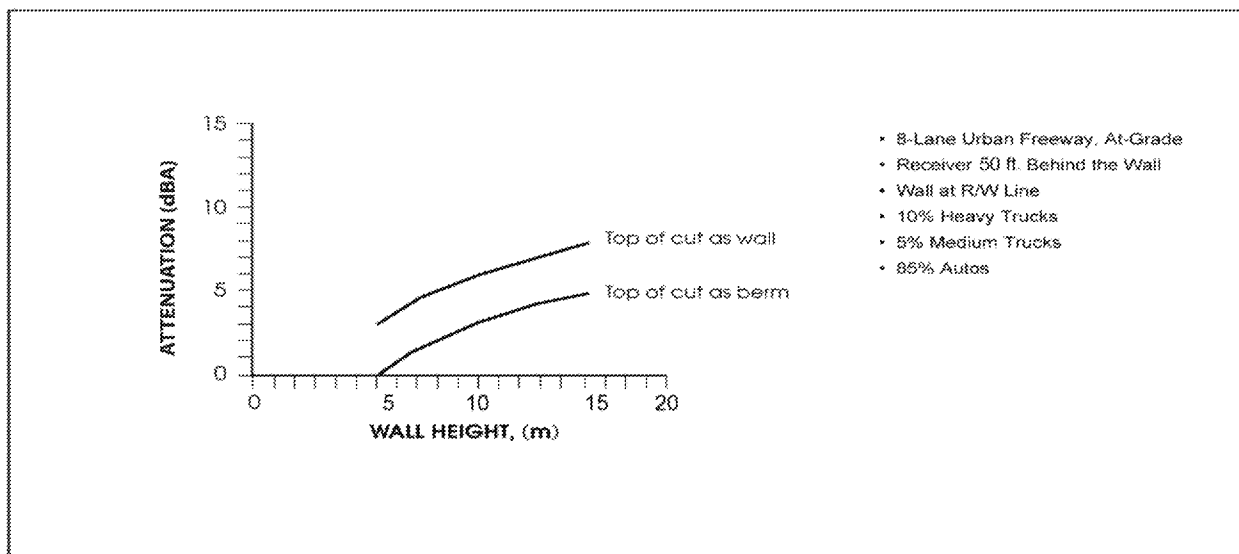

**Figure 5-13.** Soundwall Attenuation vs. Height for 25-Foot Depressed Freeway

Both the before and after conditions would then involve a wall. Likewise, if the before-and-after-conditions consist of berms (built at or near the top of cut), the upper curve also would be a correct representation. The lower curve consists of attenuation differences between a soundwall and the existing top of cut, with the latter treated as a berm. The additional 3-dBA attenuation provided by the before condition is eliminated by the wall, making it less effective.

A similar phenomenon may also be encountered when freeways are built on embankments. Receivers located near the top of fill may be fully or partially shielded from traffic by the top of fill or hinge point. For these receivers, a wall built on top of the embankment may be less effective than for receivers located farther from the freeway.

The above discussions illustrate the importance of noise source, barrier, and receiver relationships in designing effective noise barriers. These geometries not only affect the barrier attenuation, but also noise propagation in many cases. Section 2.1.4 discusses hard- and soft-site characteristics. The excess noise attenuation provided by a soft site is caused by the noise path's proximity to a noise-absorbing ground surface. If a noise barrier is constructed between a source and receiver, the diffracted noise path is lifted higher off the ground, causing less noise absorption by the ground and a lower rate of noise attenuation with distance. Figure 5-14 illustrates this concept.

In "a," the before-barrier situation shows a noise attenuation rate of 4.5 dBA per doubling of distance. In "b," the after-barrier attenuation is 3

dBA per doubling of distance. The lower attenuation rate reduces the barrier's effectiveness.

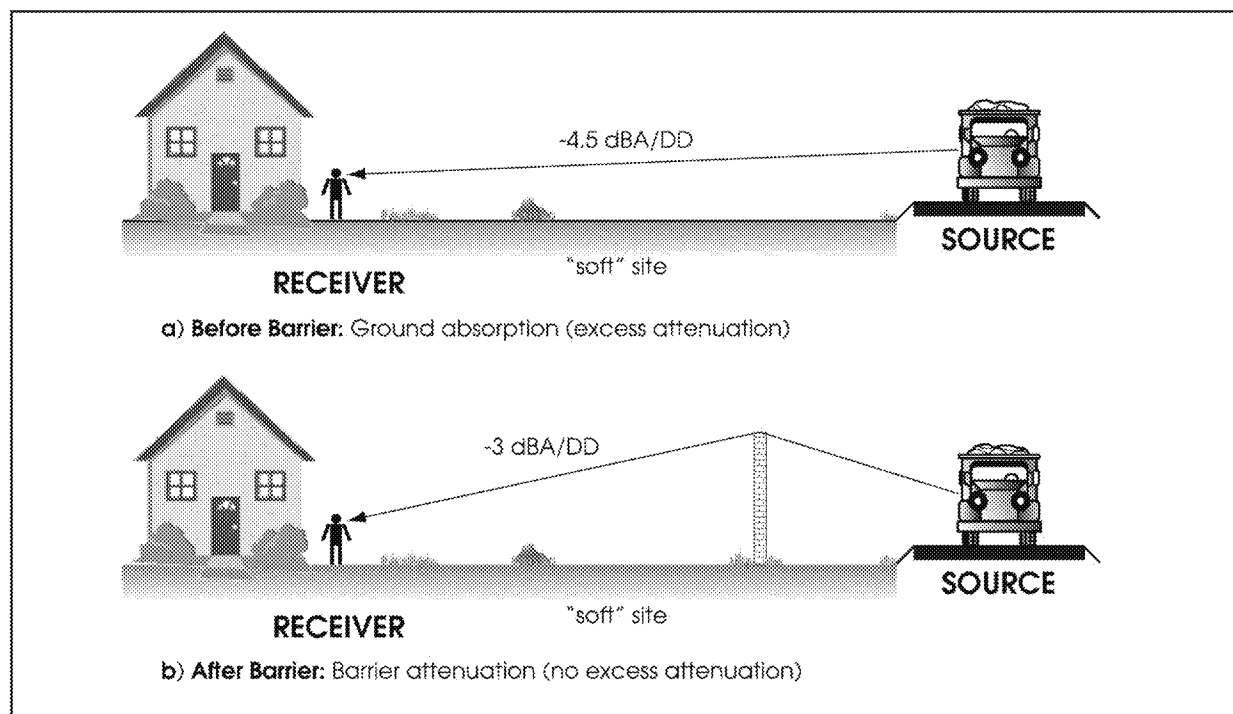

**Figure 5-14.** Loss of Soft-Site Characteristics from Constructing a Noise Barrier

The potential of a barrier to be less effective than indicated by barrier attenuation alone gave rise to the term insertion loss. Section 5.1.5 discusses the difference between barrier attenuation and insertion loss in detail. The insertion loss of a barrier is the net noise reduction provided by a barrier at a receiver. It includes barrier attenuation and before- and after-barrier differences in noise propagation characteristics (i.e., it is the actual noise reduction caused by inserting a noise barrier between source and receiver). A measured insertion loss is usually referred to as field insertion loss.

Finally, another height consideration in the acoustical design of noise barriers is Caltrans guidance to break the line of sight between an 11.5-foot-high truck exhaust stack and 5-foot-high receiver in the first row of houses. This guideline, detailed in *Highway Design Manual* Chapter 1100, is intended to reduce the visual and noise intrusiveness of truck exhaust stacks at the first-line receivers.

Barrier heights determined by TNM often satisfy the acoustical requirements without shielding high truck exhaust stacks. Although such barriers may reduce noise levels sufficiently to meet feasibility and design goal requirements, they have generated complaints from the public in the

past when truck stacks were visible. The line of sight break criterion occasionally governs the height of a noise barrier.

The 11.5-foot height used for truck stacks was determined to be the average (50th-percentile) height of truck stacks in a 1979 District 7 study, including 1,000 heavy trucks measured at a truck inspection station along I-5. This means that the line-of-sight break will shield first-line receivers from the exhaust stacks of about half of the trucks on the highways.

The 11.5-foot dimension is not related to the noise source heights used for heavy trucks in TNM and therefore should not be used for noise predictions. Determining the line-of-sight break is a separate process from predicting noise and is completed with the line-of-sight module in TNM. Generally, it is desirable to calculate and plot the break profile along the barrier alignment before the acoustical design of the noise barrier. . If more than one barrier alignment is under consideration, the line-of-sight break must be calculated for each alignment alternative.

The line-of-sight break height depends on the three-dimensional locations of the 11.5-foot truck stack, receiver, and bottom of the barrier (interface between barrier and ground). To calculate the height for a certain source, barrier, and receiver combination, the designer needs to determine the critical truck stack lane, which is the lane in which the 11.5-foot truck stack creates the highest line-of-sight break. Figure 5-15 shows a quick method of determining which lane is critical. If the receiver is located above a baseline drawn through far- and near-lane truck stacks, the far lane is critical. If the receiver is located below this line, the near lane is critical. When the receiver is on the line, either lane is critical. Please note that the line does not need to be horizontal or level.

*Highway Design Manual* Chapter 1100 does not give guidance on whether the entire barrier or only a portion of the barrier should break the line of sight for a certain receiver. On one extreme, a series of line-of-sight intercepts can be calculated from one receiver, covering the entire barrier. On the other extreme, only one intercept can be calculated using a perpendicular line from the receiver to the barrier or highway. In the absence of an official policy, it is recommended that a distance of  $2D$  left and right along the centerline of the critical lane, measured from a perpendicular line from the receiver to the lane, be used (where  $D$  = the distance from receiver to the lane). Also, it is recommended that the portion of the barrier evaluated be further constrained by a maximum distance from receiver to truck stack ( $D_1$ ) of 500 feet. Figure 5-16 shows the recommended constraints.

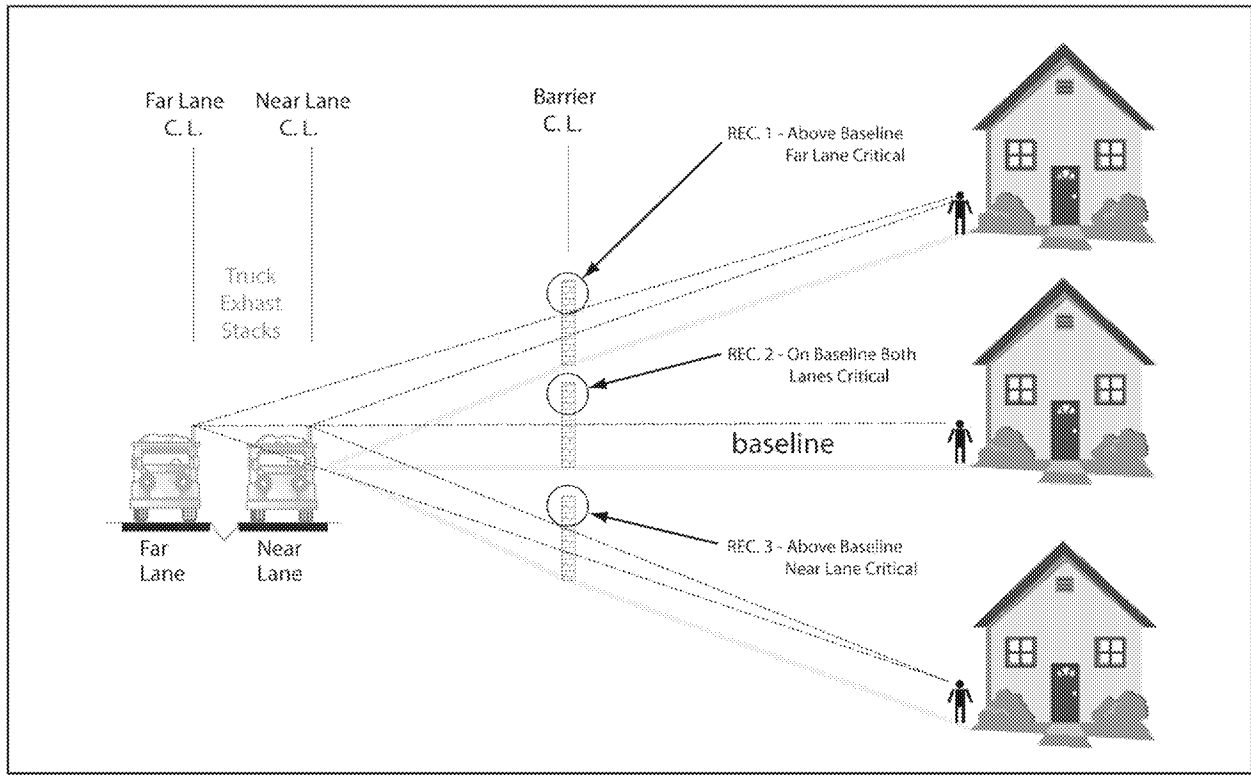

Figure 5-15. Determination of Critical Lane for Line-of-Sight Height

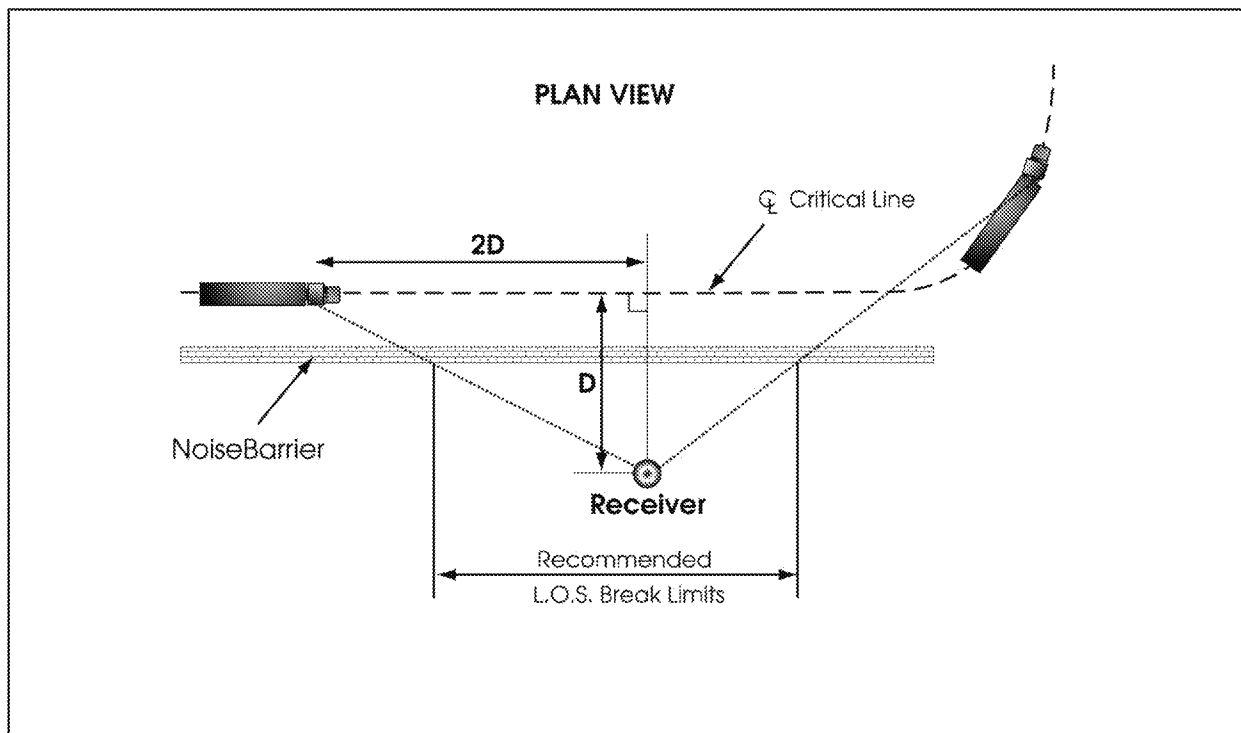

Figure 5-16. Recommended Line-of-Sight Break Limits

### 5.1.3.2 Length

A noise barrier should be sufficiently long to protect the end receivers (see Figure 5-17). If the barrier is not long enough, the exposed roadway segment will contribute a significant portion of noise energy received and sharply reduce the effectiveness of the barrier. For example, if a barrier ends at the receiver, half of the roadway is exposed, and the noise reduction by the barrier is 3 dBA or less.

As a general rule, a noise barrier should extend at least 4D beyond the last receiver (where D = the perpendicular distance from barrier to receiver) (see Figure 5-18). The “4D rule,” however, should be considered a starting point, and the FHWA TNM should be used to precisely locate the end of the barrier. Often, the critical end receivers are not in the first row of homes, but several rows farther from the highway (see Figure 5-17). As the barrier-to-receiver distance increases, highway noise becomes lower, but the barrier segment angle is also reduced, making a potential noise barrier less effective. The FHWA TNM is needed to resolve these opposing factors.

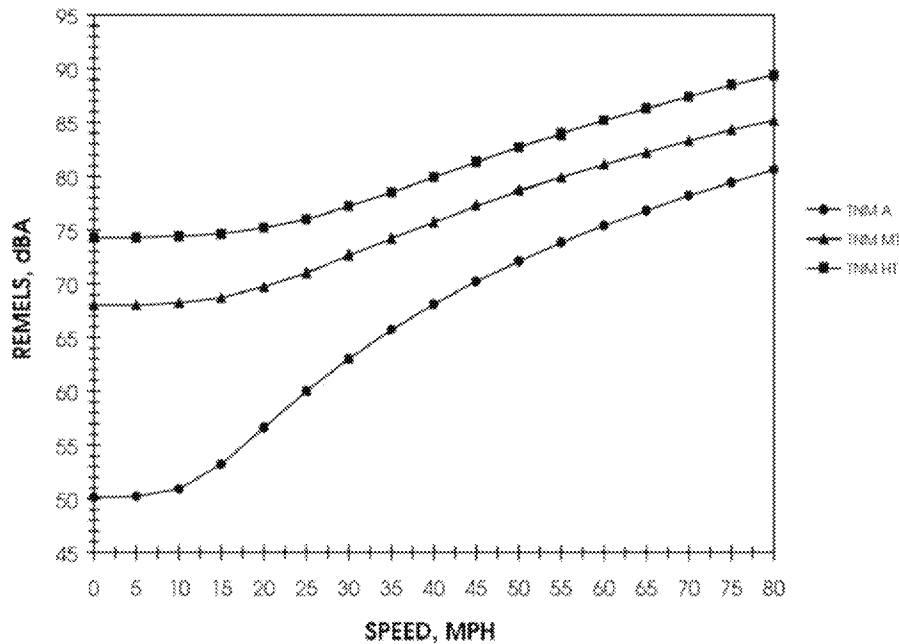
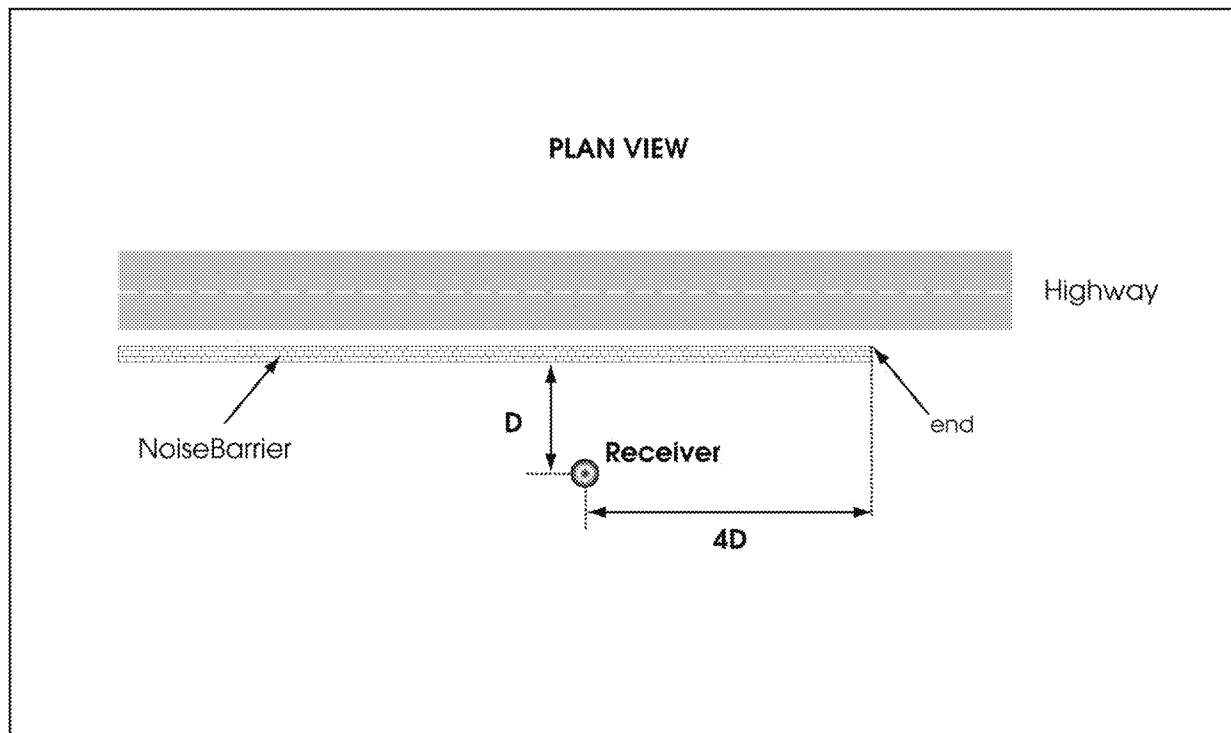

Figure 5-17. Barrier Extended Far Enough to Protect End Receivers



**Figure 5-18. 4D Rule**

Another way of addressing end receivers is shown in Figure 5-19. The barrier is “hooked” around the critical receivers. The obvious advantage of this design is the shorter barrier length compared to the normal barrier extension. The disadvantage is the need for legal agreements between Caltrans and the private property owners concerning construction easements, barrier maintenance, and responsibilities.

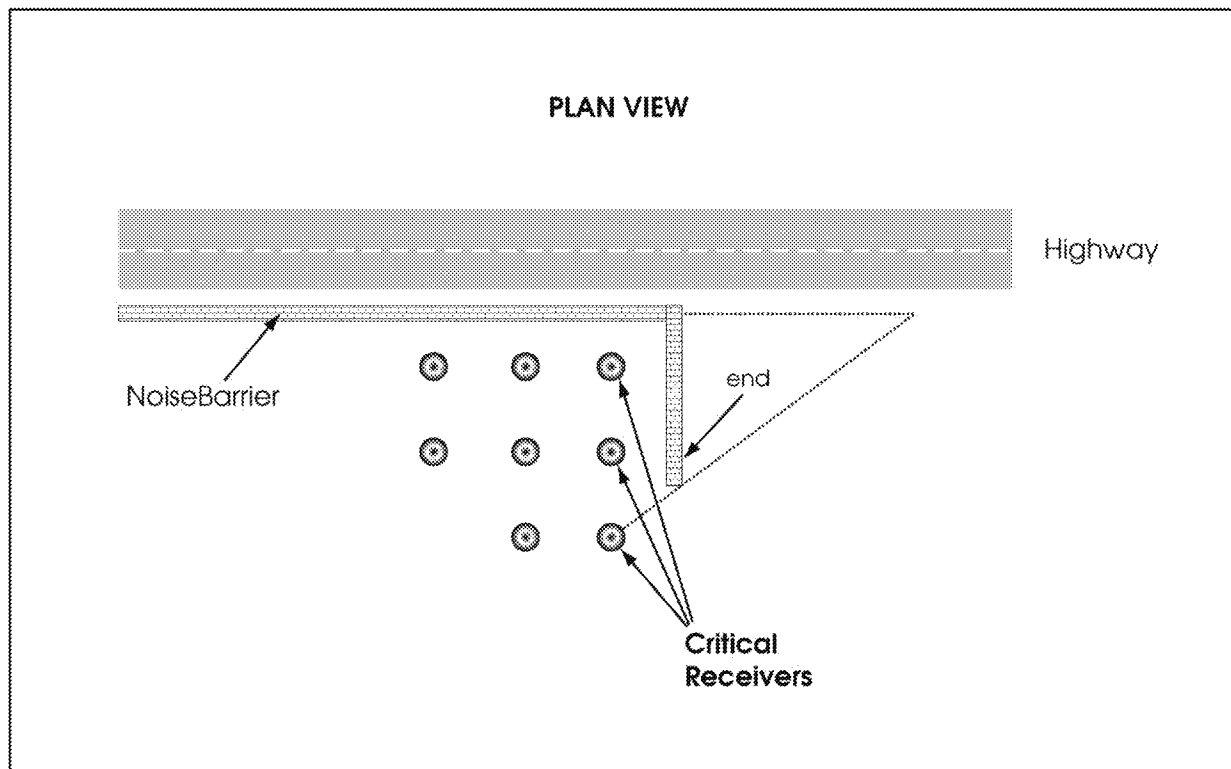

Figure 5-19. Barrier Wrapped around End Receivers, an Effective Alternative

### 5.1.4 Barrier Shape

Section 4.5.1 indicates that the FHWA TNM distinguishes between two noise barrier shapes: thin screen (wedge) and earth berm. Figure 5-20 shows representations of the two barrier shapes.

Given the same site cross section, distance between source and receiver, and barrier height, a berm allows greater barrier attenuation than the thin screen (wedge), such as a soundwall. In general the actual extra attenuation associated with a berm is somewhere between 1 and 3 dBA.

There are several probable causes for the extra 3-dBA attenuation for a berm. The flat top of the berm allows a double diffraction, resulting in a longer path-length difference. Also, the noise path is closer to the ground (berm surface) than for a thin screen, allowing more ground absorption.

Other barrier shapes have been researched, including “T-tops,” “Y-tops,” pear-shaped tops, and curved walls. Given the same total wall height, these do little to improve barrier attenuation, usually only about 1 or 2 dBA at most. Figure 5-21 shows some different shapes. The added cost of constructing and complexity of these shapes usually does not justify the small acoustical benefit.

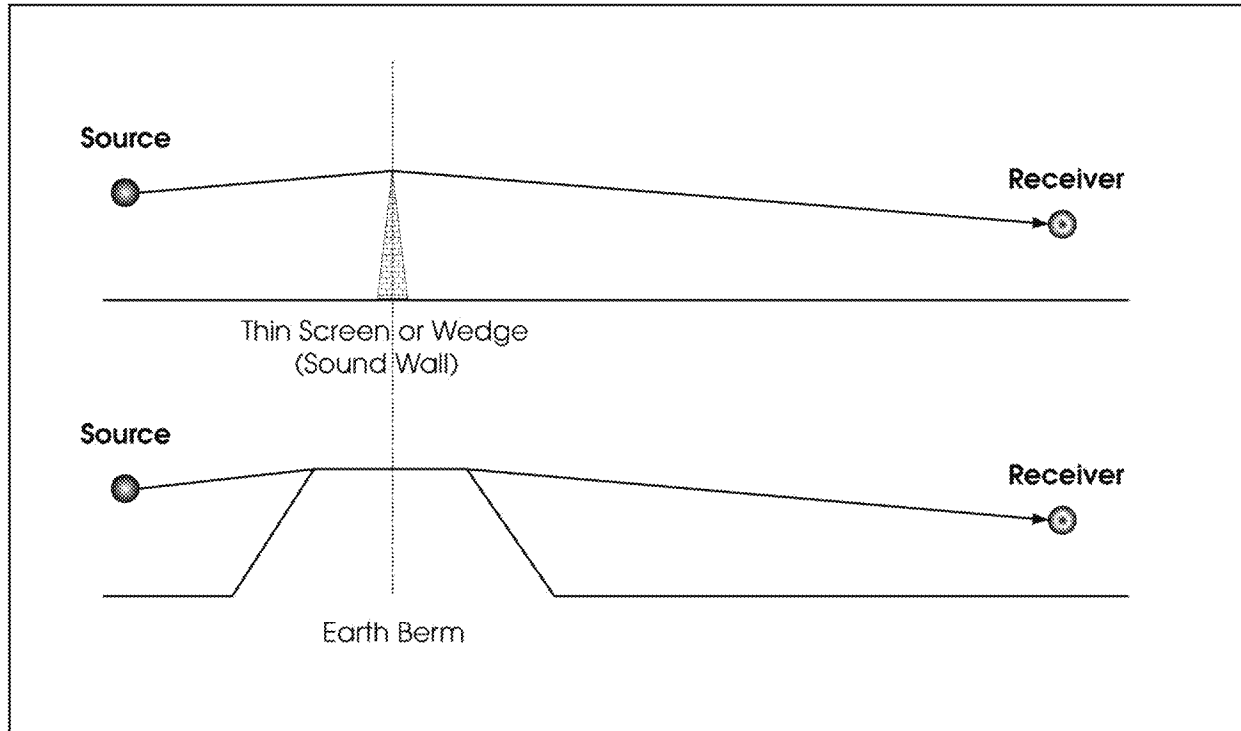

**Figure 5-20.** Thin Screen vs. Berm (Berm Gives More Barrier Attenuation)

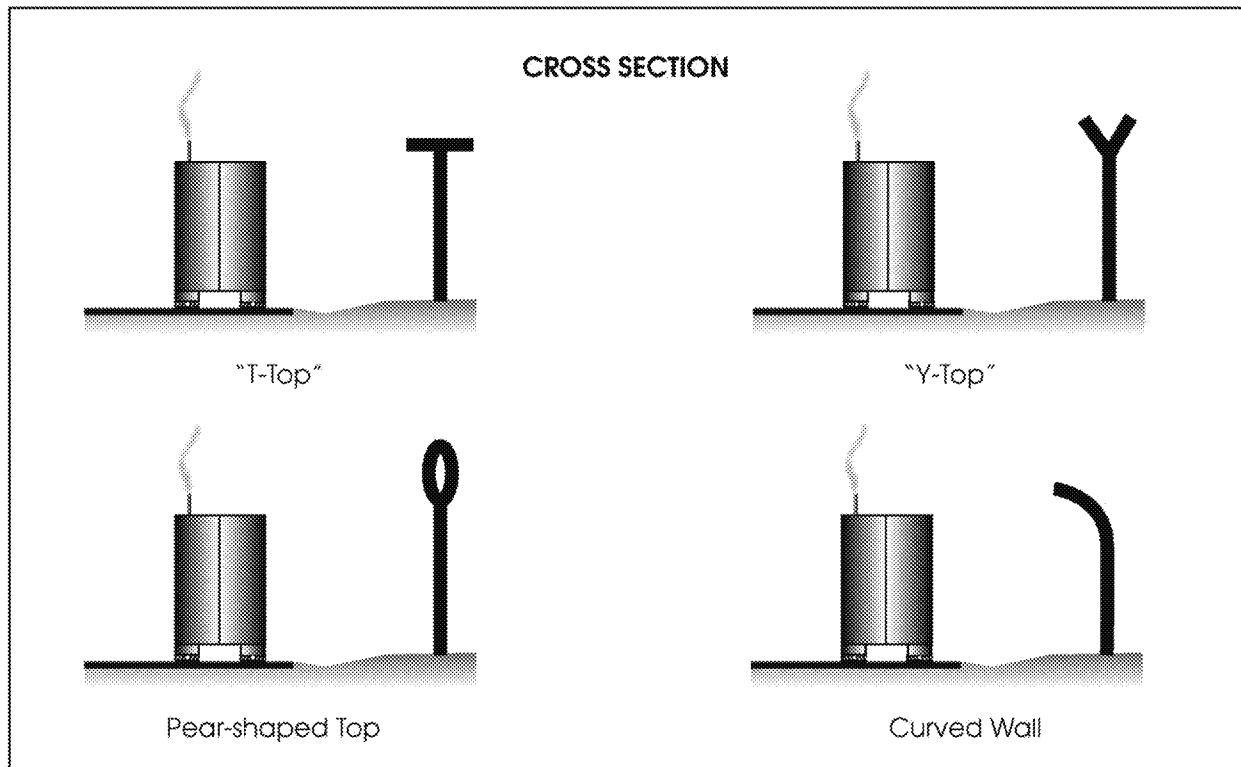

**Figure 5-21.** Various Wall Shapes (Minimal Benefit for Extra Cost)



There is also a question of jeopardizing safety with any overhang, especially when the barrier is constructed near the edge of the shoulder.

## 5.1.5 Barrier Insertion Loss vs. Attenuation

In simple terms, barrier insertion loss is the difference in noise levels before and after a barrier is constructed. It accounts for barrier attenuation, contributions from unshielded roadway segments, changes in dropoff rates, and interaction with existing barriers (e.g., reflections or additional shielding).

Figure 5-22 illustrates the difference between barrier insertion loss and attenuation. Barrier attenuation only accounts for noise attenuated from noise barrier diffraction, integrated over the length of the noise barrier. Barrier insertion loss is the net noise reduction and includes barrier attenuation, changes in noise path heights and associated changes in ground effects, flanking noise, and other noise sources. When designing noise barriers, barrier insertion loss is the primary factor of interest.

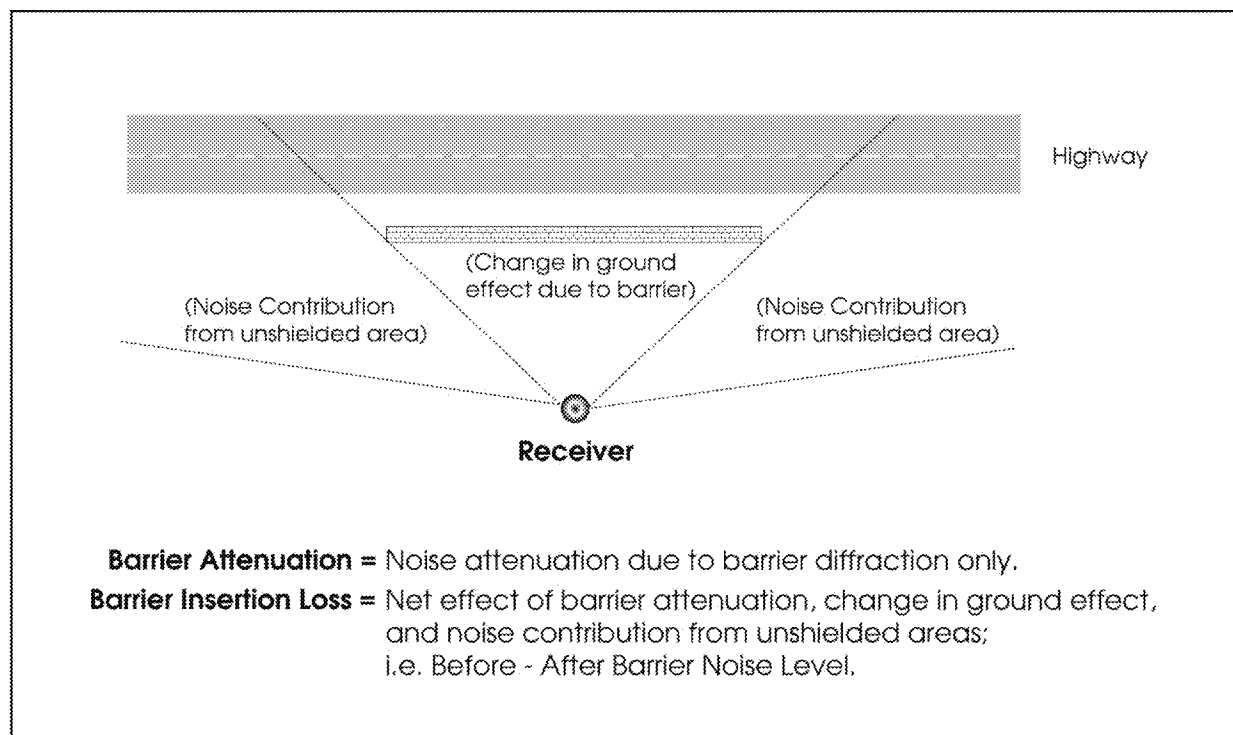

Figure 5-22. Barrier Insertion Loss vs. Attenuation

## 5.1.6 Background Noise Levels

One important factor to be considered but often overlooked in noise barrier design is the background noise level within a community. A noise barrier cannot reduce noise levels below the noise level generated by local traffic on surface streets. For instance, if the background level (without the highway) is 65 dBA at the target receivers, and a proposed project will raise this level to 68 dBA, a noise barrier will not be able to reduce the noise level to less than 65 dBA. Therefore, the community background noise level always should be added into the predicted noise levels and considered in the noise abatement design process. Only if it is obvious that the background noise from local sources will not influence the noise barrier's insertion loss (i.e., is at least 10 dBA less than the predicted noise level with the noise barrier) can the background noise be ignored.

The following is an example of how background noise levels can influence noise barrier calculations.

### Given

Background noise level: 60 dBA at receivers

New facility (without background): 68 dBA at receivers

Total predicted: 69 dBA at receivers

The goal of this exercise is to design a noise barrier that will reduce the total noise level at the receiver by at least 5 dBA. The model predicts traffic noise levels without the background noise level. However, the background noise level should be accounted for in the total noise attenuation. Therefore, the predicted noise level needed to reduce the total predicted noise level at the receiver to 64 dBA must be calculated.

### Calculation

If the barrier reduces the noise from the new facility by 5 dB the facility noise level would be 64 dBA. When the background noise is considered the resulting sound level would be 65 dBA (60 dBA + 64 dBA). This is only a 4 dB reduction from the total predicted noise level of 69 dBA. Additional attenuation is needed to provide at least 5 dB of noise reduction relative to the total predicted noise level.

The goal is for the background sound level plus the new facility noise level behind the barrier to be 64 dBA (5 dBA below the total predicted noise level of 69).

background (B) + new facility noise level behind barrier (N) = 64 dBA

$$B + N = 64 \text{ dBA}$$

$$60 + N = 64 \text{ dBA}$$

$$N = 64 - 60$$

$$N = 10\log(10^{(64/10)} - 10^{(60/10)})$$

$$N = 61.8 \approx 62 \text{ dBA.}$$

Therefore the barrier must provide a total noise reduction of 7 dB and result in a noise level of 62 dBA behind the barrier for the net noise reduction to be at least 5 dBA.

## 5.1.7 Reflected Noise and Noise Barriers

### 5.1.7.1 Noise Reflection

The reflection of noise from barriers can be a source of concern for residences in the vicinity of a barrier. A barrier that reduces noise at receivers on one side of the highway could potentially alter the noise at receivers on the other side. The complex nature of noise barrier reflections, difficulties in measuring them, and controversy surrounding the significance of their impacts deserve detailed discussion.

More noise barriers have been constructed in California than in any other state, in many different configurations of alignment, profile, and height. These barriers are located along one or both sides of highways of different widths; along ramps, connectors, and interchanges; and in urban, suburban, and, rural regions under varying traffic conditions. The receivers for which they were designed are located in many different types of terrain, topography, and climate. The combinations and permutations associated with the vast variety of conditions inevitably increase the possibility of creating controversies over the extent of noise reflections by barriers. Therefore, it is only natural that noise reflection issues are on the

rise in California, especially because almost all noise barriers here are made of noise-reflective material with hard, smooth surfaces, such as masonry and concrete. In most cases, the noise increases from reflections are so small that most people do not notice them. The people who do perceive increases in noise are usually suddenly made aware of freeway noise by an event that triggers that awareness (e.g., construction of the noise barrier). Measured increases from noise reflections of more than 2 dBA have never been measured by Caltrans, but claims of 10 and even 20 dBA increases have been made occasionally.

Many complaints of large increases in noise came from residents living far from the highway and were actually from changes in meteorology. Atmospheric refraction from wind shear and temperature gradients can account for 10- to 15-dBA variations when the same sources are measured from distances of approximately 1 to 2 miles. To measure the effects of noise reflections, before- and after-barrier noise measurements need to be carefully matched by wind speed, wind direction, temperature gradients, air temperature, humidity, and sky cover. Likewise, if a person perceives a noticeable increase in noise levels from a reflective noise barrier, he or she must be able to compare it mentally with a before-barrier condition that included the same meteorology. Of course, this process is very unreliable. The effects of noise barriers on distant receivers are discussed in Section 7.

This section addresses various aspects of noise reflection concerns in detail. The following classifications of reflective noise with respect to noise barriers and other structures will be discussed.

- Single barriers (on one side of the highway).
- Parallel barriers (on both sides of the highway).
- Structures and canyon effects.

Compared with reflections measured under similar conditions, results of theoretically modeled noise reflections normally show higher values. This overprediction of reflection models has been attributed to the inability of models to accurately account for all the variables, such as interactions with atmospheric effects and the unknown degree to which traffic streams interfere with reflections.

Reflective noise is not peculiar to noise barriers. Retaining walls and other structures reflect noise in the same manner as noise barriers. The principles discussed in this section can be applied to reflective barriers, reflective retaining walls, or any other smooth, continuous, hard surfaces.

## 5.1.7.2 Single Barriers

### Simple Terrain

Figure 5-23 is the simplest two-dimensional representation of single-barrier reflections. The presence of a reflective barrier on the opposite side of an at-grade highway essentially doubles the acoustic energy at the receiver. In addition to the direct noise ray “d,” the barrier reflects a noise ray “r” of roughly the same acoustic energy (actually, “r” is longer than “d” and will result in slightly less acoustical energy). Theoretically, only one reflective ray reaches the receiver because the angle of incidence equals the angle of reflection (both depicted as  $\theta$  in Figure 5-23). Therefore, even if they are equal, “r” and “d” cause a doubling of energy that increases the noise level by 3 dB at the receiver.

Figure 5-24 shows that for an infinite line source and noise barrier the reflections are also an infinite line source. At each point along the highway, there is only one reflection ray that reaches the receiver and for which the angle of incidence equals the angle of reflection.

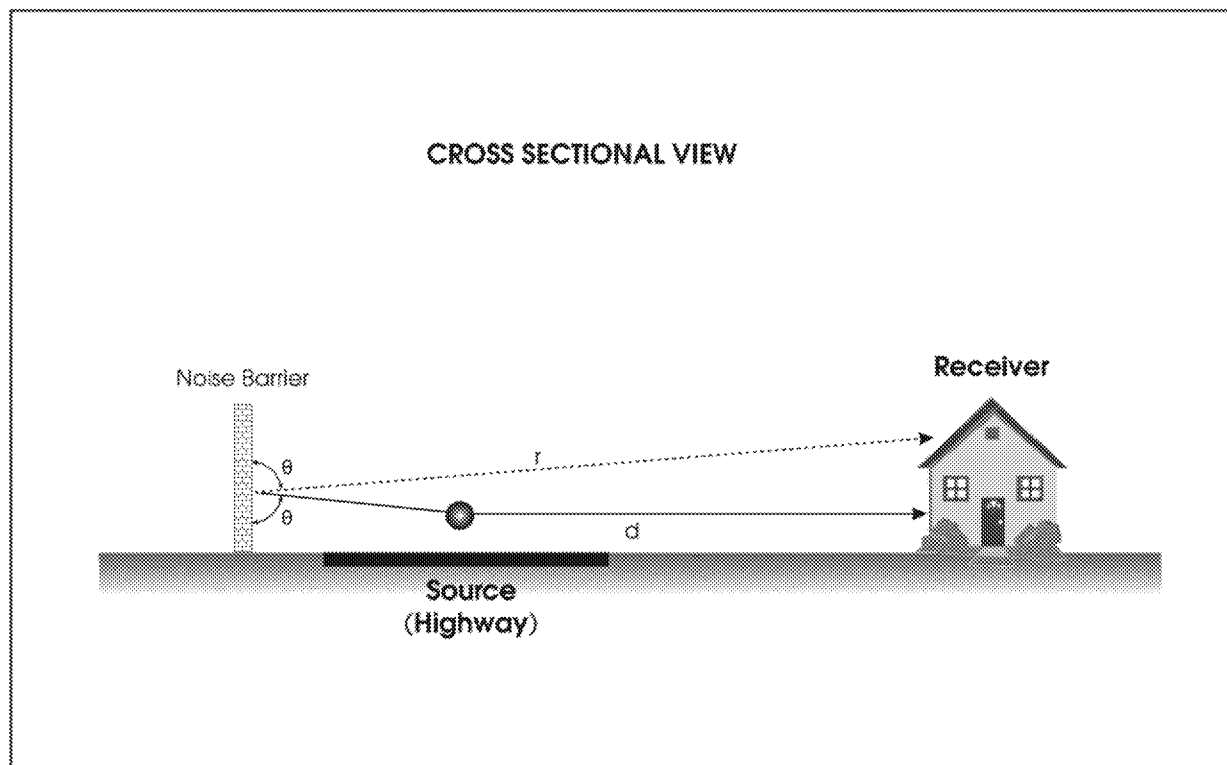
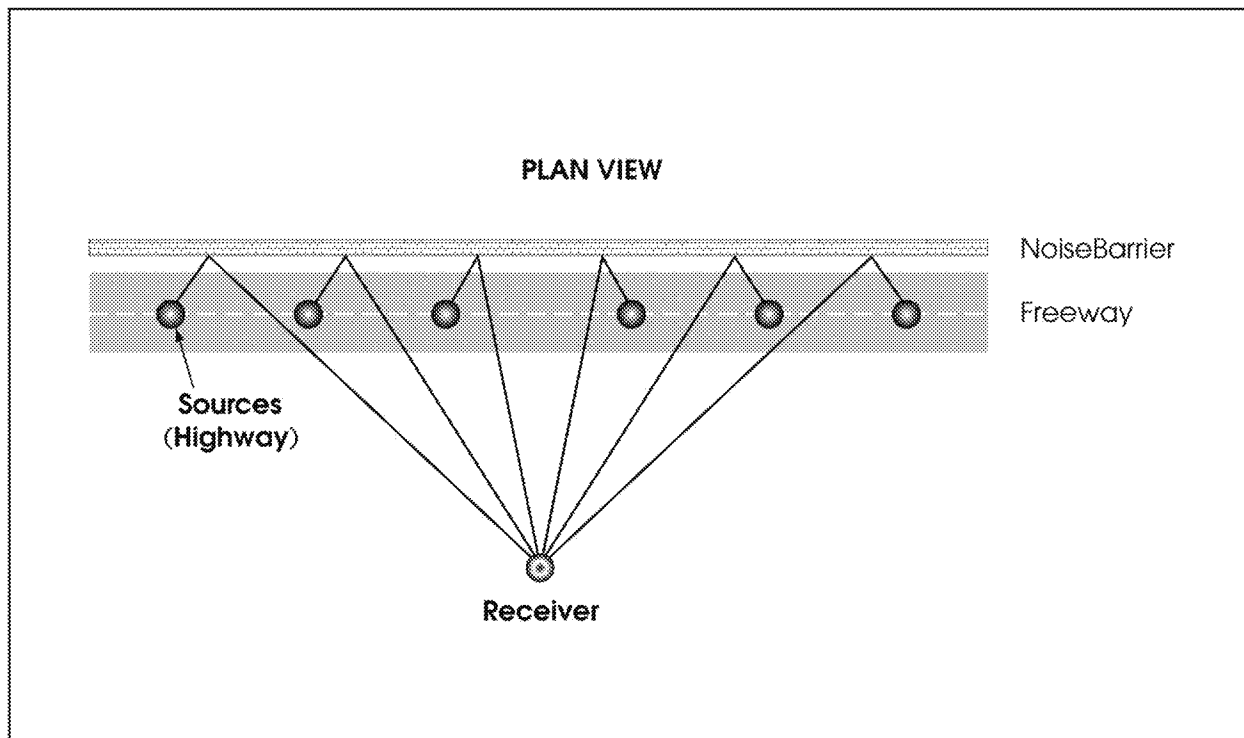

Figure 5-23. Single-Barrier Reflection (Simplest Representation)



**Figure 5-24.** Single-Barrier Reflections (Infinite Line Source and Noise Barrier)

Figure 5-25 is a more realistic depiction, which includes pavement reflections. Please note, however, that a noise barrier on the opposite side still increases the noise level by 3 dB, although the before and after noise levels are 3 dB higher (because of pavement reflections) than in Figures 5-23 and 5-24. In plan view, the pavement reflections would also be shown to be a line source. The reflection point  $R_1$  (Figure 5-25) may fall off the pavement on absorptive ground, reducing the before-barrier noise levels at the receiver. The pavement reflection point  $R_2$ , however, which is significant only after building the barrier, usually will be on the pavement. Therefore, the difference between before- and after-barrier noise levels could in theory slightly exceed 3 dBA.

The effects of single-barrier reflections are distance-dependent. At distant receivers, the ratios of direct/reflected noise path lengths and those for near- and far-lane distances approach 1. When this is the case, contributions of direct and reflected noise from each lane contribute roughly the same energy (there will always remain a slight loss of acoustical energy because of imperfect reflections). The result would be an increase that approaches 3 dBA for distant receivers. For receivers close to the highway, however, the distance ratios become less than 1, and the noise at the receiver is dominated by direct noise from the near lanes. The result is less contribution from reflected noise.

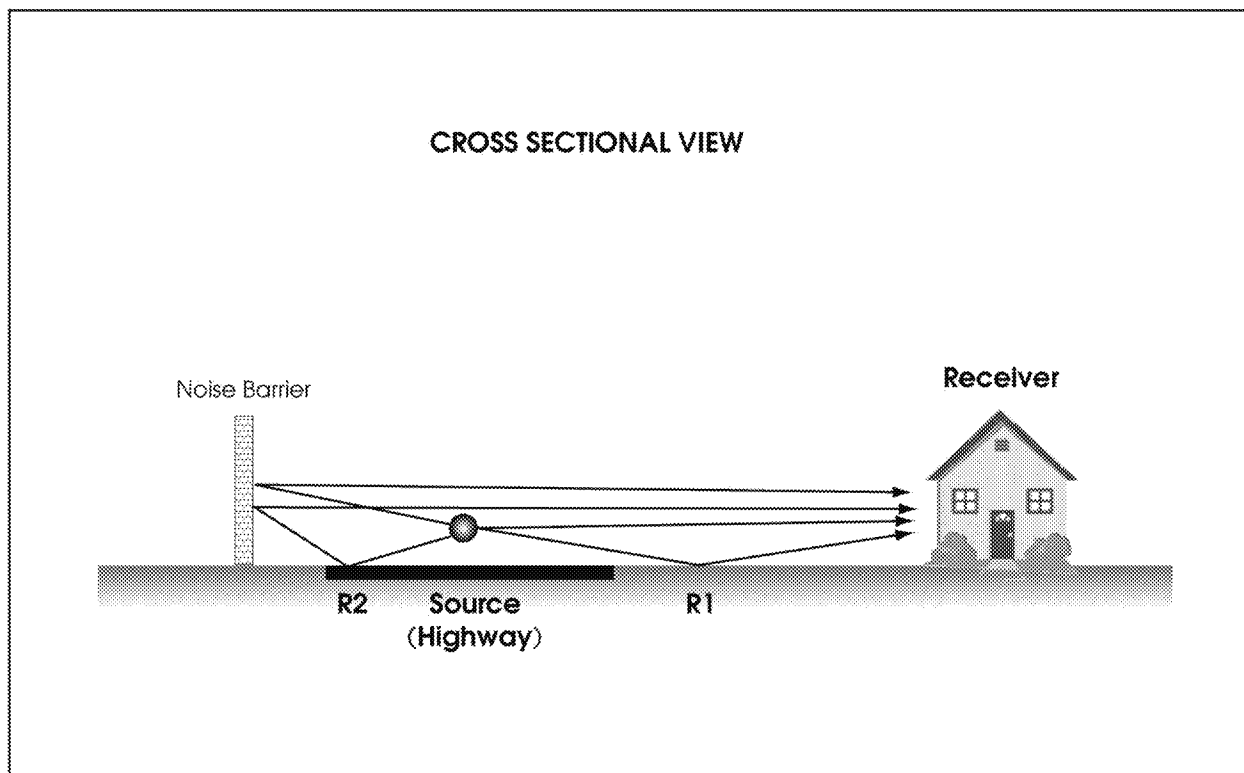

**Figure 5-25.** Single-Barrier Reflection (More Accurate Representation)

Figure 5-26 shows the distance dependency of the noise increases from barrier reflections for a typical eight-lane at-grade freeway. At 50 feet from the edge of the traveled way, the increase is only 1.3 dBA, at 200 feet it is 2.0 dBA, and at 400 feet it is 2.4 dBA. The increases were calculated assuming equal noise source distributions in the near and far (eastbound and westbound) lanes and hard-site propagation.

Real-world situations are far more complicated than shown in Figures 5-23 to 5-26. The noise sources are distributed over the width of the highway, the paths of the barrier noise reflections are always longer than the direct noise paths, reflective barriers are not perfect reflectors, and the traffic stream likely interferes with the reflections. Because of these factors, reflected noise contributions are less than those of direct noise and seldom increase noise levels by more than 1 or 2 dB.

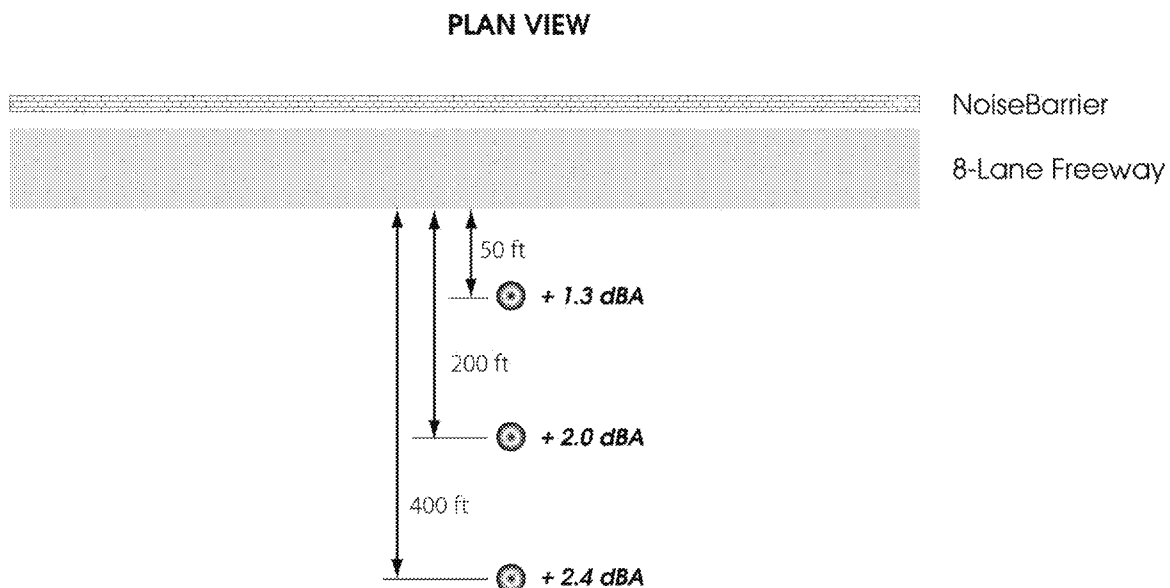
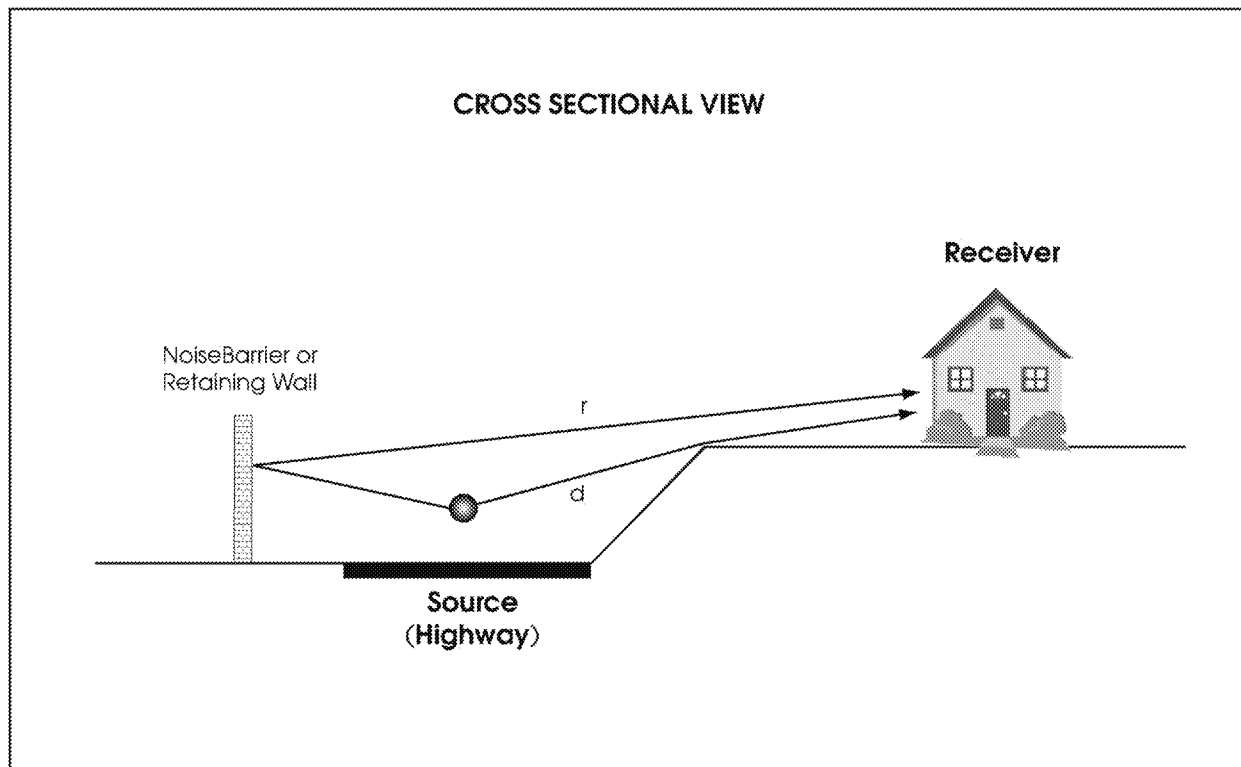

**Figure 5-26.** Noise Increases from Single-Barrier Reflections

### Complex Terrain

In more complex terrain there are instances when single-barrier reflected noise could increase noise levels perceptibly at a receiver. One such case is shown in Figure 5-27, which depicts a receiver that is effectively shielded by terrain or the top of a depressed highway cut. If a noise barrier or retaining wall were constructed on the opposite side of the highway, unshielded reflected noise ray “r” could contain significantly more acoustical energy than the shielded direct ray “d,” causing a noticeable increase in noise at the receiver. However, real-world situations are far more complex than illustrated. Some of the noise sources or noise paths may be shielded, while others may not. In general, if most of the traffic cannot be seen from the receiver while most of the noise barrier is visible, it is possible that the barrier noticeably increased noise levels at the receiver.



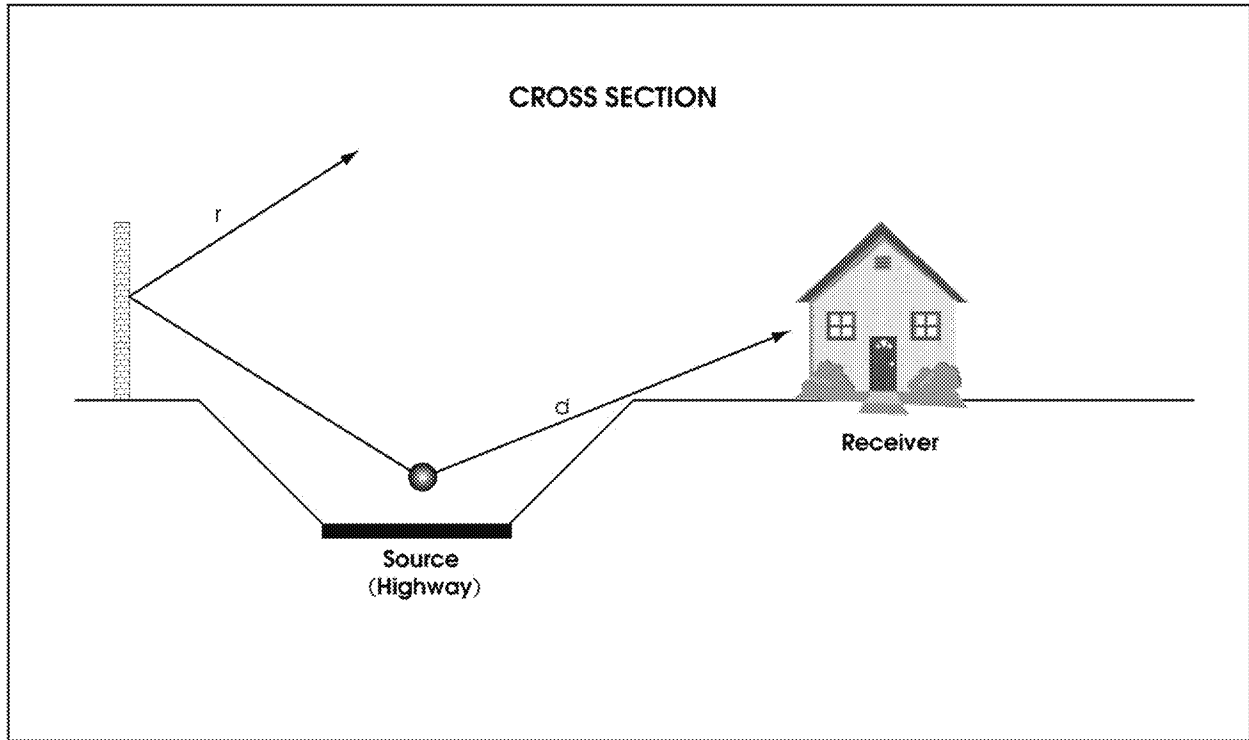

**Figure 5-27.** Single-Barrier Reflection (Direct Noise Shielded, Reflected Noise Not Shielded)

Reflections off single barriers located at the top of cut (Figure 5-28) generally are directed over a 5-foot-high receiver on the opposite side and therefore are usually not a concern for low receivers. However, higher receivers— the second floor of a residence or receivers located on a higher hill behind the front receivers—still may be affected by the reflections if the direct noise is shielded.

Situations depicted in Figures 5-27 and 5-28 (high receivers only) may increase noise levels by 3 to 5 dBA, depending on the angle of reflections and the height and length of the reflective barrier.

Single barriers on the top of fills (Figure 5-29) generally do not present any reflection issues. The reflected noise ray is usually well above the receiver.



**Figure 5-28.** Single-Barrier Reflection (Noise Barrier on Top of Opposite Cut)

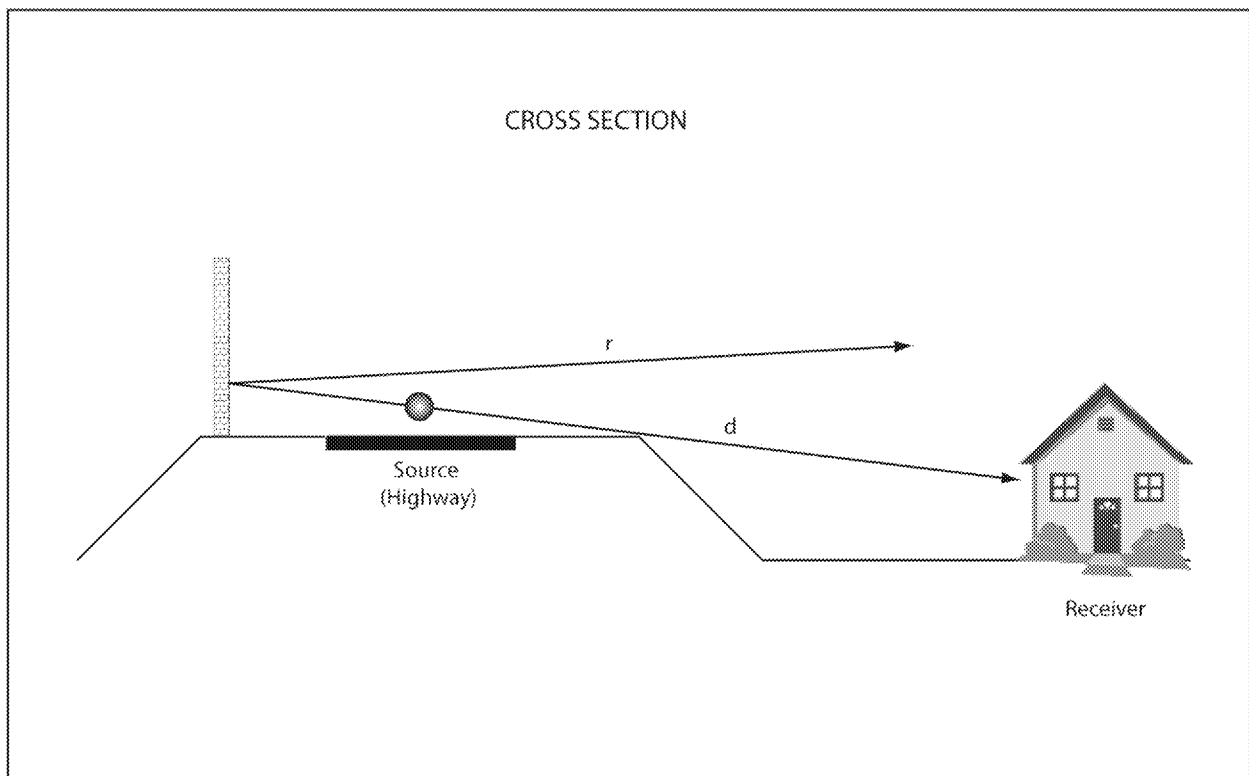

**Figure 5-29.** Highway and Noise Barrier on Fill

### 5.1.7.3 Modeling Single Barrier Reflections

TNM currently has no provisions for calculating single barrier reflections. In the future, however, it is planned to have that capability.

For simple situations, the effects of reflections can be evaluated in TNM using image sources. Figures 5-30 and 5-31 illustrate these concepts in cross section and plan views.

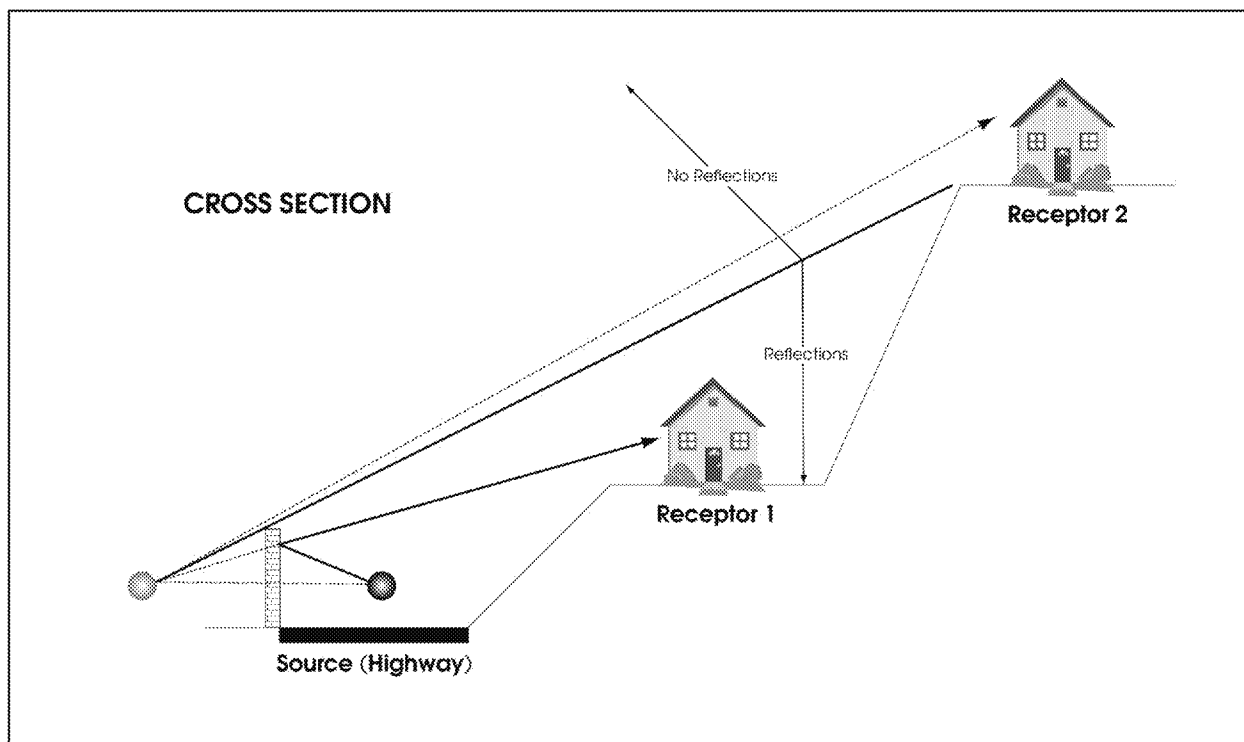

Figure 5-30. Placement of Image Sources (Cross Sectional View)

Figure 5-30 illustrates the placement of an image source in cross section by drawing a line perpendicular to the reflective wall (or its vertical extension) that passes through the real source. The image source is positioned on that line at the same distance from the wall as the real source but on the opposite side. The image source is analogous to a mirror image of the real source, with the wall acting as the mirror.

It is important to point out that just as mirror images cannot be seen from all angles, not all image sources necessarily contribute to reflections. A straight line drawn from the image source to the receiver must pass through the wall before the image source can contribute to the noise at the receiver. Please note that Receptor 1 lies in the “zone of reflections,” while Receptor 2 does not experience reflective noise. In some cases, there

are reflections from cars but not heavy trucks, or vice versa, depending on the site geometry. In other cases, only traffic noise from certain lanes will be reflected, while noise from others will not. Accurate site cross sections will reveal which image sources are relevant.

Figure 5-31 illustrates how an image source can be created in a plan view. A general case is shown with a finite wall that is not parallel to the roadway. Examination of Figure 5-31 reveals that for the purposes of creating an image source a finite wall creates a unique finite image line source for a particular receiver on the opposite side of a highway.

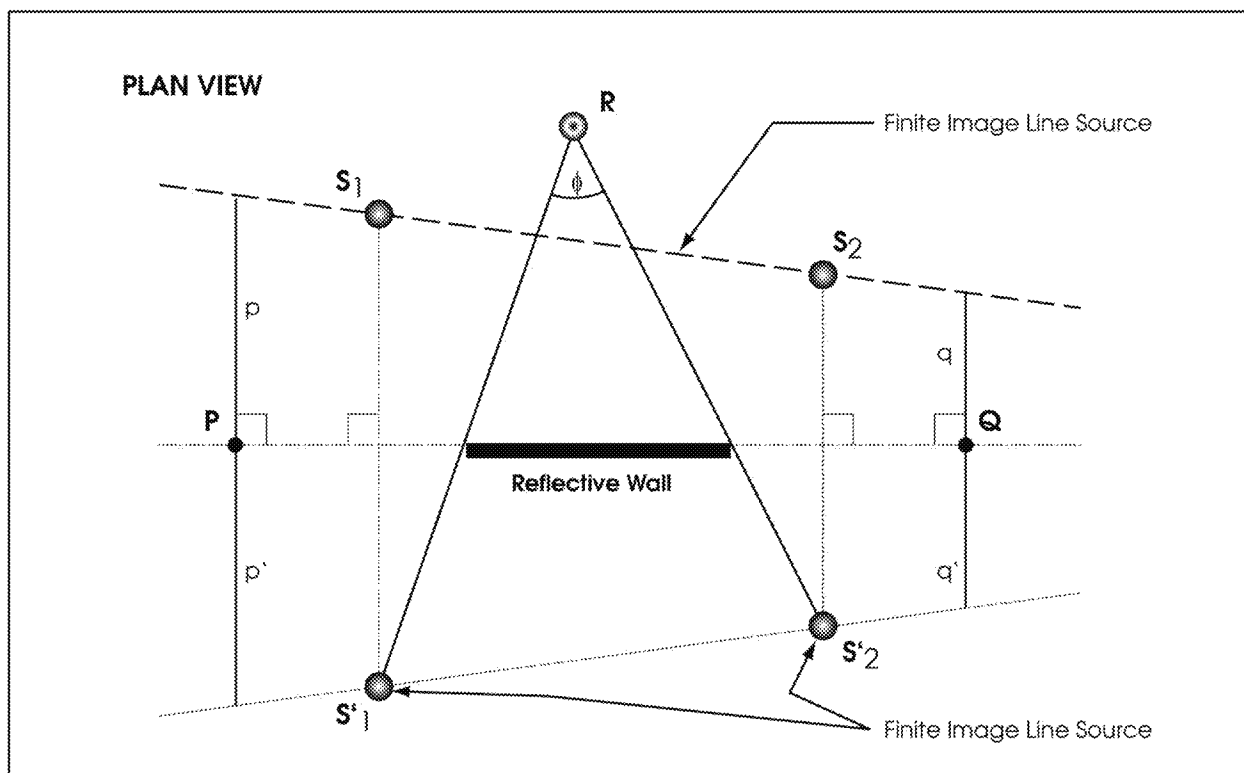

**Figure 5-31.** Placement of Image Sources (Plan View)

To construct the finite image line source, lines perpendicular to the wall or its extensions at two random locations (e.g.,  $P$  and  $Q$ ) can be drawn. Along these lines, distances  $p$  and  $q$  from the wall to the roadway line  $L$ , at  $P$  and  $Q$ , respectively, can be measured and reconstructed on the image side of the wall ( $p = p'$ ,  $q = q'$ ). A line  $L'$  connecting the two points defined by distances  $p'$  and  $q'$  establishes the direction of the image line source. Next, the termini of the infinite image line source can be determined by the intersections of line  $L'$  with two lines from the receiver  $R$  through both end points of the wall.  $S'_1$  and  $S'_2$  are now the end points of the finite image line source and represent image sources of real sources  $S_1$  and  $S_2$ . To correctly account for the reflections at  $R$ , the finite image source  $S'_1$  –

$S'_2$  must be input along with the infinite real line source  $L$ . Because the reflective wall does not shield  $R$ , it must not be included in the analysis.

Please note that for a given source and noise barrier length, the locations  $S'_1$  and  $S'_2$  will be receiver-dependent. For each receiver location, the finite image source  $S'_1 - S'_2$  will have a different length unless both the real line source and reflective wall are deemed infinite. When analyzing the effects of the reflections from the wall, each receiver must be analyzed and modeled separately unless both the line source and reflective wall are infinitely long. However, where receiver locations do not change the length of  $S'_1 - S'_2$  significantly, the length may be averaged and applied to these receivers.

Only primary reflections should be considered when employing the above methods. Further, because each receiver is affected by a different set of reflections, the number of receivers modeled should be minimized. Even in that case, however, modeling of reflective noise can be very cumbersome. TNM does not currently have provisions for reflection calculations except for the parallel barrier analysis module discussed in the next section.

#### 5.1.7.4 Parallel Barriers

Multiple reflections between reflective parallel noise barriers can potentially reduce the acoustical performance of each individual barrier. Figure 5-32 shows a simple illustration of only five of the many possible reflective paths in addition to the direct path to the top of the barrier. Theoretically, there are an infinite number of possible reflective noise paths. Each reflection essentially becomes a new source, which may add to the noise diffracted by the barrier nearest to the receiver. This in turn may reduce the barrier's effectiveness.

However, Figure 5-32 clearly shows that as the number of reflections for each possible path increases, the path length becomes significantly longer. However, in all instances the barrier-to-receiver distance is the same. Only the path lengths from source to receiver that are located between the barriers change. For the direct path, this distance is defined as  $W - S$ , where  $W$  is the separation distance between the two barriers and  $S$  is the distance from the far barrier to the source.

For the first reflective path, the distance is approximately  $W + S$ . For the second reflective path, it is approximately  $3W - S$ . Further examination of Figure 5-32 shows that the path length difference between the first reflective path and the direct path is  $2S$ . The difference between the second and first reflective paths is  $2(W - S)$ . The pattern repeats itself for

subsequent reflections. These increases in path length distances for each subsequent reflection soon make their contribution to the total diffracted noise insignificant (only the first few reflections are important).

For example, for the special case where  $W = 2S$  (source halfway between the barriers), each subsequent reflective path increases by  $W$ . Assuming that the distance between the source and receiver  $D = W$  (a fairly typical situation) and the Noise Reduction Coefficient (NRC) is 0.05 (95% of energy reflected at each reflection point), the contribution of each subsequent reflection decreases rapidly because of increasing path length, as shown in Table 5-2. The table assumes only the effects of increasing distances and a slight absorption by the walls (5% at each reflection point), and does not include the effects of the location of the final point of reflection with respect to the source location. This affects the amount of diffraction by the wall on the receiver side, which will be different for each reflective path. Pavement reflections, constructive and destructive interference of sound waves, frequency shifts, effects of the traffic mix, traffic stream, and lane distribution are ignored also.

Noise contributions from parallel barrier reflections obviously depend on the source-to-receiver distance. For a fixed  $W$ , the relative distance attenuation for each reflective path decreases as  $D$  increases. The contribution of each reflection also increases as  $W$  decreases in relation to  $D$  (Figure 5-32).

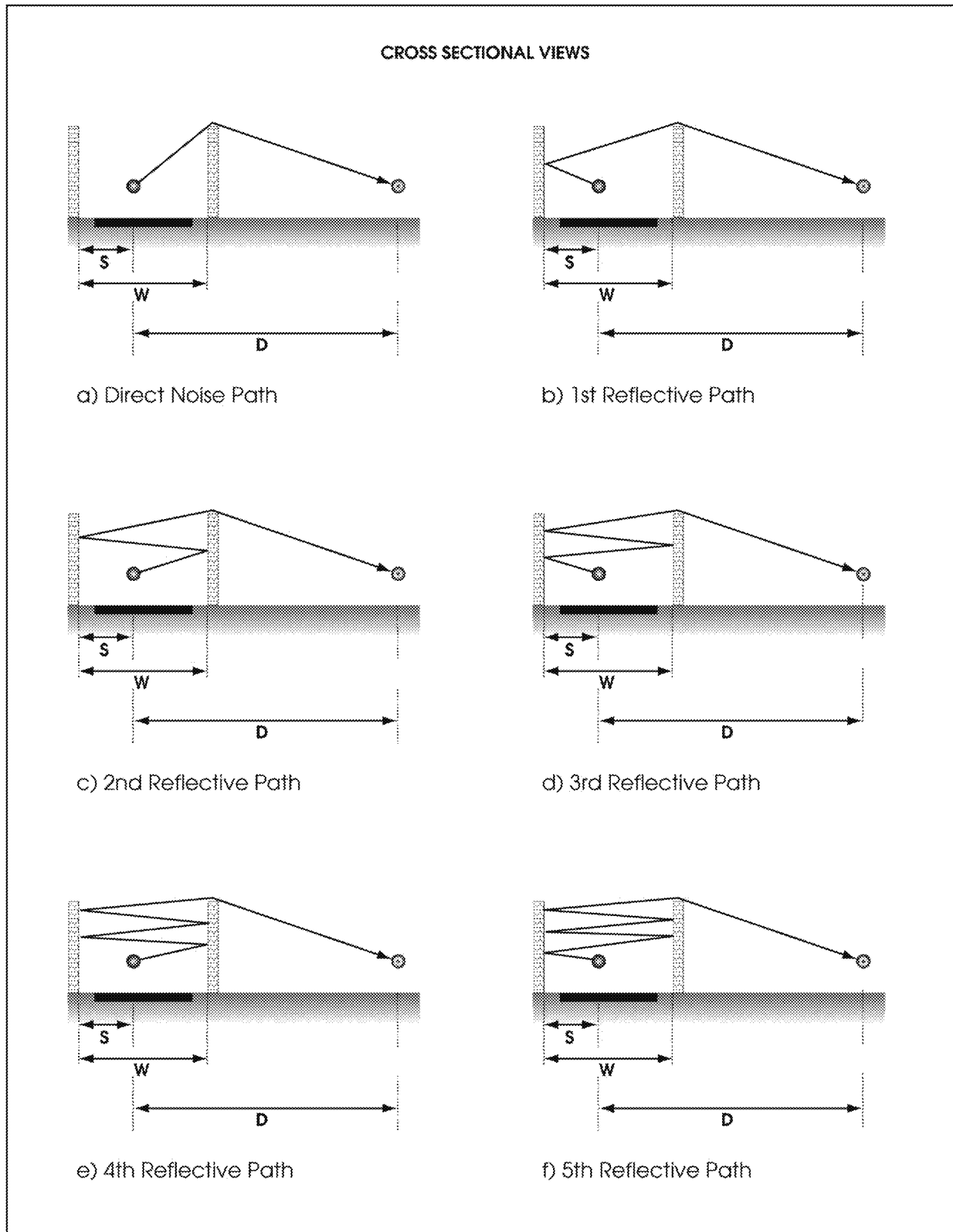

**Figure 5-32.** Various Reflective Noise Paths for Parallel Noise Barriers

**Table 5-2.** Contribution of Reflections for Special Case Where  $W = 2S$ ,  $D = W$ , and  $NRC = 0.05$ 

Noise Path	Distance, (Source to Receiver of Reflected Paths)	(1) Distance Adjustment (Direct to Reflective Path) $10\log(W / NW)$ (where $N = 2$ through 11) (dBA)	(2) Absorbed ( $NRC = 0.05$ ) (dBA)	(1 + 2) Contribution (RE: Direct) (dBA)	Cumulative Total Noise Level (RE: Direct) (dBA) (Direct + 1st Reflective + 2nd Reflective, etc.)
Direct	W	0 (Ref.)	0	0 (Ref.)	0 (Ref.)
1st reflective	2W	-3.0	-0.2	-3.2	+1.7
2nd reflective	3W	-4.8	-0.45	-5.25	+2.5
3rd reflective	4W	-6.0	-0.7	-6.7	+3.0
4th reflective	5W	-7.0	-0.9	-7.9	+3.3
5th reflective	6W	-7.8	-1.1	-8.9	+3.6
6th reflective	7W	-8.5	-1.3	-9.8	+3.8
7th reflective	8W	-9.0	-1.6	-10.6	+3.9
8th reflective	9W	-9.5	-1.8	-11.3	+4.1
9th reflective	10W	-10.0	-2.0	-12.0	+4.2
10th reflective	11W	-10.4	-2.2	-12.6	+4.3

Noise contributions of reflections between parallel barriers degrade the performance (insertion loss) of each noise barrier. The amount of degradation that takes place depends on the site geometry and barrier configurations. In addition to the factors shown in Figure 5-32 and Table 5-2, there is another important relationship between the ratio of the separation between two parallel barriers ( $W$ ) and their average height ( $H_{AVG}$ ), and the amount of insertion loss degradation. As a rule, if the  $W / H_{AVG}$  ratio is 10:1 or more, the insertion loss degradation is less than 3 dBA. This has been supported by research done by Caltrans and others (California Department of Transportation 1991 and Federal Highway Administration 1990). Because of suggested noise barrier height limits in the *Highway Design Manual*, parallel noise barriers in California typically have a  $W / H_{AVG}$  ratio of 10:1 or more. Although there have been claims to this effect, there are no known instances in which reflective parallel noise barriers in any configuration have ever measurably increased noise levels over those without noise barriers. The  $W / H_{AVG}$  guideline applies not only to noise barriers, but also to retaining walls or combinations of both. Figure 5-33 illustrates these concepts.



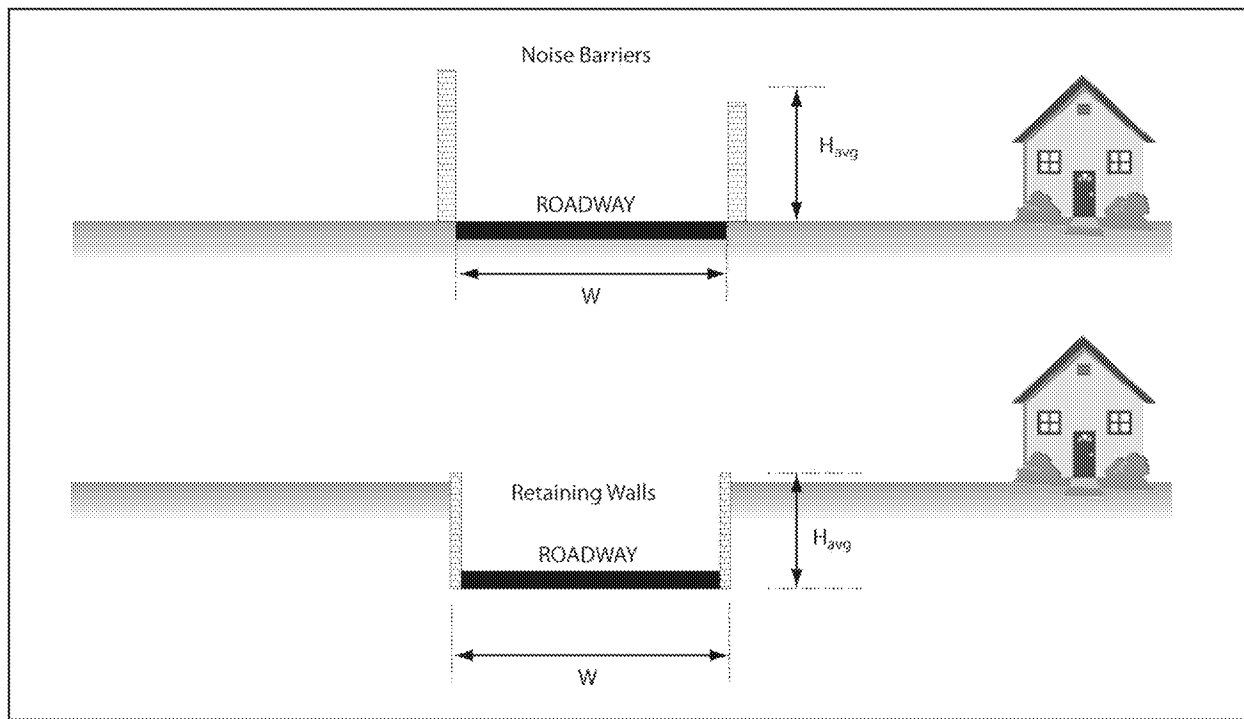
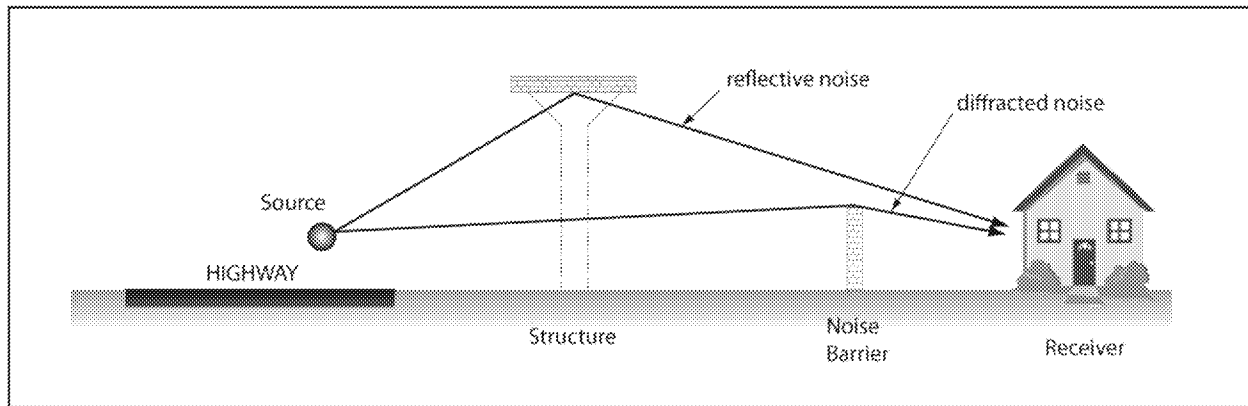

Figure 5-33.  $W / H_{AVG}$  Ratio Should be 10:1 or Greater

### 5.1.7.5 Reflections off Structures and Canyon Effects

Generally, the same rules that apply to reflections off noise barriers also apply to those off retaining walls. Because the height limitations to noise barriers do not pertain to retaining walls, there is more potential for noise reflections, especially when the retaining walls are along stretches of depressed freeways. However, no noise barriers in this configuration have ever been shown objectively and conclusively to result in higher noise levels than those of a similar at-grade freeway because of reflective noise.

Complex multi-level highway interchanges can present some challenges in noise abatement design. The widespread spatial distributions of traffic noise sources and receivers make it difficult to design noise barriers that interrupt all direct noise paths between the many source-to-receiver combinations. Additionally, reflective surfaces of concrete structural components create many opportunities for noise reflections to circumvent noise barriers. Figure 5-34 shows one example of a potential complication created by the interaction of structures and noise barriers.



**Figure 5-34. Noise Reflection off Structure**

The structure in the illustration provides a point (or line) of reflection off the structure's soffit. This essentially creates a new line source with respect to the receiver shown. Unlike the highway noise sources that are shielded from the receiver by the noise barrier, the reflected noise (new source) is not shielded.

High median barriers (e.g., 5-foot-high concrete glare screens) are typically not considered an issue. Because of the barriers' limited height, reflections most likely are scattered and interrupted by the traffic stream.

The effects of reflections near tunnel portals can substantially increase noise at receptors near the portal. A study conducted in Germany (Woehner 1992) provides guidance on how to reduce noise at tunnel portals by applying acoustical absorption to the tunnel walls near the opening. The report indicates that the depth of treatment into the tunnel should be 2 to 3 times the diameter of the tunnel opening.

To date, Caltrans measurements have yet to conclusively reveal issues associated with the interaction between structures and noise barriers. The effects of reflections off structures would be limited because of the small reflecting surface and therefore affect only a relatively small group of receivers because of the small reflecting surface.

Studies of highways through canyons typically have shown noise increases of less than 3 dBA from canyon effects. Noise increases generated from highways in narrow canyons with steep side slopes theoretically could be more than 3 dBA, depending on groundcover and the steepness and smoothness of side slopes. The canyon walls, to some extent, act as parallel soundwalls with respect to multiple reflections. However, unless the slopes are perfectly vertical, buildup of reflections will be more limited because of the slope angles.

Highways on hillsides with nearly vertical rock cuts are somewhat similar to the single barrier situation discussed previously. No perceptible noise increases are expected. Because of the angle of the cut slope, reflections are directed skyward, while receivers would likely be below the highway.

### 5.1.7.6 Double-Deck Bridge Reflections

A special case of multiple noise reflections is a double-deck bridge. Frequently, noise measurements taken at receivers near such a structure differ substantially from those modeled for the same conditions because of the model's inability to account for the noise contributions generated by lower-deck traffic, and reflecting between the lower road deck and the bottom (soffit) of the upper deck. An example of how to calculate the contributions of these reflections manually will be shown in this section.

In Figure 5-35, the noise levels at the receiver are determined by the direct diffracted path from the lower deck traffic (sources  $S_1$  and  $S_2$ ), traffic from the upper deck, and contributions from reflections between the lower deck and the soffit of the upper deck. The direct noise levels from the lower and upper decks can be modeled in the TNM. The contributions of the multiple reflections between the decks, however, cannot be modeled in TNM and require manual calculations that can be added to the results of TNM. To accomplish this, ignore the contributions of the upper-deck traffic and begin by modeling the geometry of the lower deck, the receiver, and the associated traffic at  $S_1$  and  $S_2$ . In Figure 5-35, the direct paths from  $S_1$  and  $S_2$  are diffracted by the barrier at the edge of the lower deck.

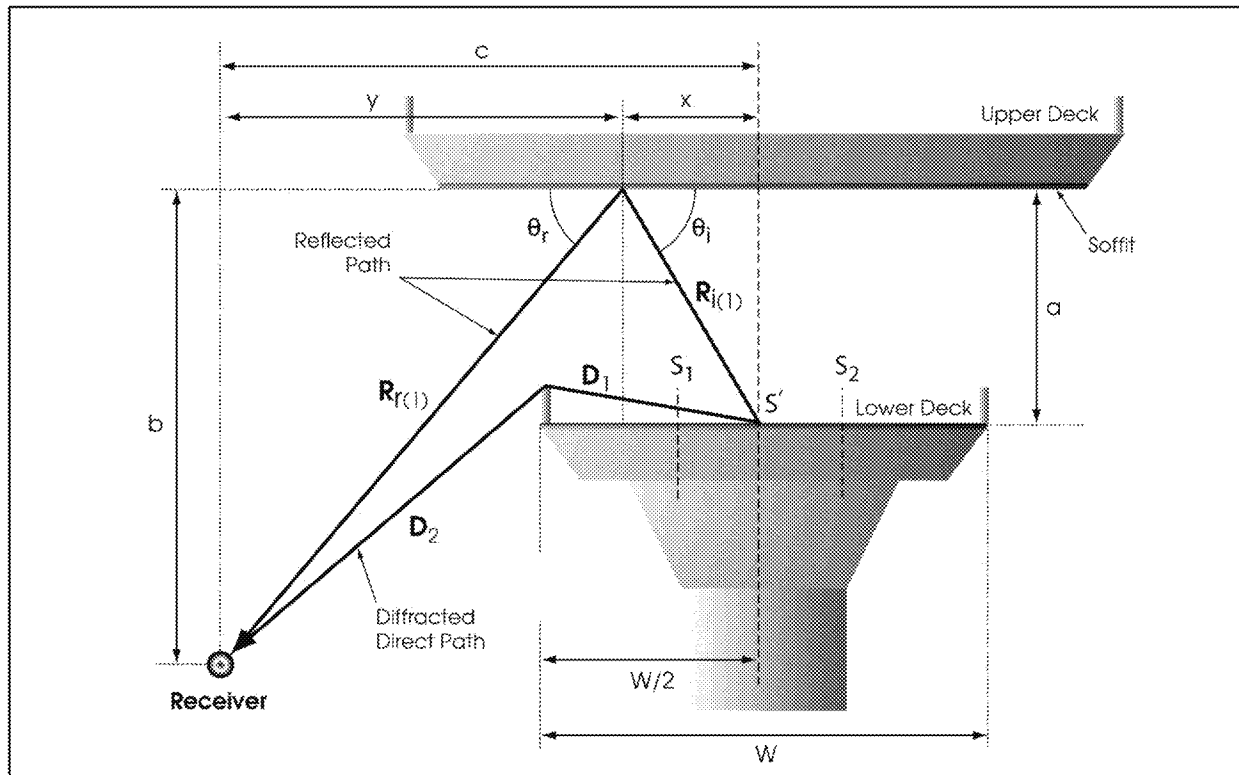

Figure 5-35. Double-Deck Structure Reflections, First Reflective Path

### Contribution of Primary Reflection

Begin by analyzing only the primary (first) reflective path,  $R_{(1)}$ , as shown in Figure 5-35. Subsequent reflections will be analyzed similarly and will be discussed later in this section.  $R_{(1)}$ , consisting of the incident path  $R_{i(1)}$  and path after first reflection  $R_{r(1)}$ , is not diffracted by the edge of the bridge. For simplicity, one path originating from  $S'$  is shown to represent an average of the primary reflective paths from both  $S_1$  and  $S_2$ . The direct diffracted paths from  $S_1$  and  $S_2$  are similarly shown as one average path originating at  $S'$ . This approximation will yield results that are sufficiently accurate. Please note that all the sources depicted in Figure 5-35 are actually lines shown on end (disappearing into the paper). Therefore, all the direct and reflected paths are actually planes and propagate as line sources.

If the path lengths of both the direct diffracted and reflected paths are known, the line-source noise contribution of the reflective path relative to the direct path can be calculated as follows:

$$10\log(D/R_{(1)}) \quad (5-2)$$

Where:

D = direct path length ( $D_1 + D_2$ )

$R_{(1)}$  = primary reflected path length ( $R_{i(1)} + R_{r(1)}$ )

However, this would be true only if D would be undiffracted. Any calculated reflected noise contributions would be relative to the undiffracted noise level originating from  $S_1$  and  $S_2$ . These contributions could then be added to the diffracted noise level at the receiver. The difference between the undiffracted and diffracted noise levels can be calculated from modeled results.

The diffracted noise level at the receiver can be modeled with the geometry shown in Figure 5-35, eliminating the upper deck. The required dimensions are all given: the line source locations  $S_1$  and  $S_2$ ; the location of the edge of the bridge deck, including a jersey or other barrier; and the dimensions a to c.

The undiffracted noise level requires relocation of the receiver while keeping the distance of the diffracted path length, and raising the receiver high enough to not be influenced by the barrier at the edge of the bridge deck. This requires the straight-line path of the receiver to be at least 5 feet higher than the top of the (jersey) barrier. The difference between the diffracted and undiffracted noise level at the receiver can now be expressed relative to the undiffracted noise level. For instance, if the diffracted noise level is 60 dBA and the undiffracted noise level is 70 dBA, the latter is the reference, and the former becomes -10 dBA.

The contribution of the primary reflections (simplified by a single path representing both paths from  $S_1$  and  $S_2$ ) can now be calculated using Equation 5-2. Using Figure 5-35, calculate the lengths of D and  $R_{(1)}$ . D can be calculated as described below:

$$D = D_1 + D_2 \quad (5-3)$$

Where:

$$D_1 \approx W/2$$

$$D_2 = \sqrt{[(b-a)^2 + (c - W/2)^2]}$$

The calculation of  $R_{(1)}$  requires additional manipulation. First, it is known the primary reflective path consists of  $R_{i(1)}$  and  $R_{r(1)}$ , and the angle of incidence ( $\theta_i$ ) equals the angle of reflection ( $\theta_r$ ). It is also known that the primary reflective path must originate at  $S'$  and end at the receiver. Within these constraints, the location of the point of reflection, which lies on the soffit of the upper deck, a distance  $x$  from  $S'$  and a horizontal distance  $y$

from the receiver, which in turn lies a horizontal distance of  $c$  from  $S'$ , can be calculated as described below. (It should be emphasized that the point of reflection and the source at  $S'$  are actually lines.)

Because  $\theta_i = \theta_r$ ,  $x/y = a/b$  (sides of proportional triangles)

Therefore,  $x = y(a/b)$  and  $y = x(b/a)$

In  $c = x + y$  (given), substitute  $y(a/b)$  for  $x$

Therefore,  $c = y(a/b) + y = y[(a/b) + 1]$  and  $y = [c/(a/b) + 1] = bc/(a + b)$

Similarly,  $x(b/a)$  can be substituted for  $y$

By the above process,  $x = ac/(a + b)$

Because  $a$ ,  $b$ , and  $c$  are given,  $x$  and  $y$  can be readily calculated.

$R_{i(1)} = \sqrt{(x^2 + a^2)}$  and  $R_{r(1)} = \sqrt{(y^2 + b^2)}$ .

$R_{(1)} = R_{i(1)} + R_{r(1)}$

The noise contribution of  $R_{(1)}$  relative to the undiffracted noise level at the receiver now can be calculated.

### **Example 1**

#### Given

$a = 30$  feet

$b = 50$  feet

$c = 60$  feet =  $x + y$

$W = 66$  feet

Undiffracted noise level from lower deck at image receiver = 70 dBA,  $L_{eq}(h)$

Diffracted noise from lower deck is 60 dBA,  $L_{eq}(h)$

#### Calculate

1. Contribution of primary reflection
2. Total noise level from lower deck at receiver (including primary reflection)

#### Step 1: Compute D

$D = D_1 + D_2$

$D_1 = W / 2 = 66 / 2 = 33$  feet

$D_2 = \sqrt{[(b - a)^2 + (c - W / 2)^2]} = \sqrt{[(50 - 30)^2 + (60 - 33)^2]} = 33.6$  feet

$D = 33 + 33.6 = \mathbf{66.6}$  feet

Step 2: Compute  $R_{(1)}$ 

$$R_{(1)} = R_{i(1)} + R_{r(1)}$$

$$R_{i(1)} = \sqrt{[x^2 + a^2]}$$

$$R_{r(1)} = \sqrt{[y^2 + b^2]}$$

a and b are given

$$x = ac / (a + b)$$

$$y = bc / (a + b)$$

$$x = (30 * 60) / (30 + 50) = 22.5 \text{ feet}$$

$$y = (50 * 60) / (30 + 50) = 37.5 \text{ feet}$$

$$R_{i(1)} = \sqrt{[22.5^2 + 30^2]} = 37.5 \text{ feet}$$

$$R_{r(1)} = \sqrt{[y^2 + b^2]} = \sqrt{[37.5^2 + 50^2]} = 62.5 \text{ feet}$$

$$R_{(1)} = 37.5 \text{ feet} + 62.5 \text{ feet} = 100 \text{ feet}$$

From Equation 5-2, the contribution of the primary reflective path is  $10\log(D / R_{(1)})$ , or  $10\log(66.6 / 100) = -1.8$  dBA (RE: undiffracted noise level). The total noise level (RE: undiffracted noise level) is -10 dBA (diffracted noise level from lower deck) plus -1.8 dBA (from primary reflection), or  $10\log(10^{-10/10} + 10^{-1.8/10}) = -1.2$  dBA. This means that because of the undiffracted primary reflection, the noise level from the lower deck at the receiver rose from  $(70 - 10) = 60$  dBA to  $(70 - 1.2) = 68.8$  dBA.

At this point, a discussion of the geometry and characteristics of the upper deck soffit surface is appropriate. In Figure 5-35, the point of reflection of the primary reflective path falls on the soffit. This may not always be the case, however, depending on the width of the upper deck and locations of the traffic sources and receivers. Each reflection must begin at the source and end at the receiver and the angles of incidence and reflection must be equal. If any of the constraints are not met, the reflection will not contribute. To determine whether the reflection contributes,  $x$  must be calculated first. The upper bridge deck must be sufficiently wide for the point of reflection to fall on the soffit surface, as determined by the distance  $x$  in Figure 5-35. If it does not, the reflection will not be a noise contributor. Similarly, the orientation of the upper deck relative to the lower deck must be accurately known. In Figure 5-35, the two decks are assumed to be parallel. If they are not, additional angle complications will be encountered in determining the reflective paths.

Other factors have been ignored so far. The soffit surface seldom is a perfect reflector (i.e., less than 100% of the incident sound energy is reflected back) at each point of reflection. If the sound absorptive characteristics of the soffit are known, Equation 5-2 can be expanded to include the fraction of incident noise energy that is reflected at each reflection point.

The equation can then be written as follows:

$$10\log[(D / R_{(1)})(1 - \alpha), \text{ or } (1 - \text{NRC})] \quad (5-4)$$

Where:

$\alpha$  or NRC = fraction of noise energy absorbed by soffit material

$(1 - \alpha)$  or  $(1 - \text{NRC})$  = fraction being reflected

If  $\alpha$  or NRC = 1, all noise energy is absorbed; none is reflected.

If  $\alpha$  or NRC = 0, no noise energy is absorbed; all is reflected

Difference between  $\alpha$  and NRC is discussed in Section 5.1.7.7 below.

For example, the NRC for a concrete surface is frequently given as 0.05. In Example 1, the contribution of the primary reflective noise path would be  $10\log[(66.6 / 100)(1 - 0.05)] = -2.0$  dBA, instead of -1.8 dBA for a 100% reflection of noise energy. The difference between perfect reflection (NRC = 0) and NRC = 0.05 is 0.2 dBA. This difference is independent of distance and cumulative for each reflection point.

### **Contributions of Subsequent Reflective Paths**

Figure 5-36 shows additional reflective noise paths from S' to the receiver. The second reflective path is almost identical to the primary noise path and consists of two reflection points, the first at S' on the pavement and the second almost coinciding with the primary reflection point.



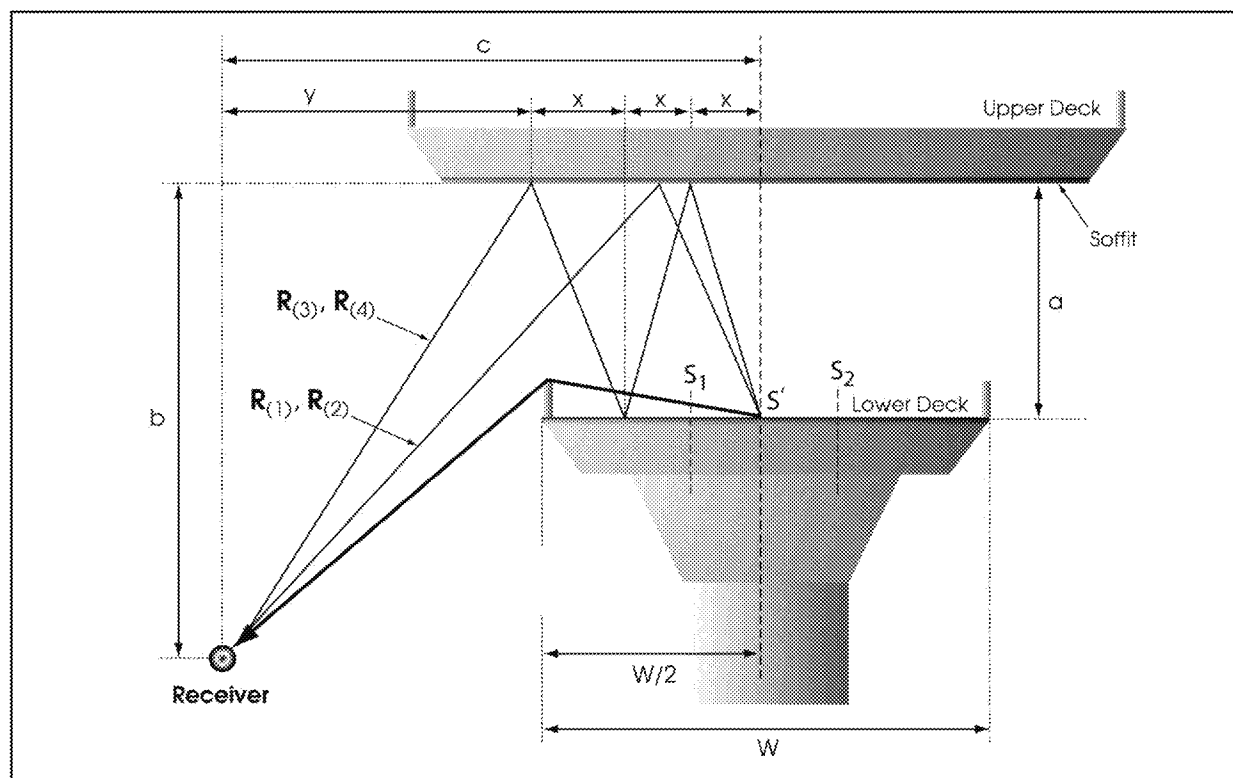

Figure 5-36. Multiple Reflective Paths

The difference between the primary and secondary noise paths is very small; therefore, they can be assumed to be the same. However, its contribution must be accounted for separately. The same is true for any even-numbered reflective path (e.g., the fourth reflective path almost coincides with the third reflective path). As discussed before, the number of possible reflective paths is limited to the following restrictions.

- Each reflective path must start at  $S'$  and end at the receiver.
- For each reflective path, the angles of incidence and reflection must be equal.
- For the  $n$ th reflective path, the last upper reflection point at distance  $(n)x$  must fall on the soffit surface.
- The last lower reflection point at distance  $(n - 1)x$  must fall on the lower deck surface.

For each reflective path, the distance  $x$  can be calculated as shown for the primary path. For the  $n$ th reflective path,  $c = y + (n)x$ . Therefore,  $x = ac / [(n)a + b]$  and  $y = bc / [(n)a + b]$ . Also,  $y = c - nx$ . Actually,  $n$  refers to the odd-numbered reflective paths only. Each even-numbered reflective path is approximately equal to the previous odd-numbered one. Therefore, the noise contributions for the even-numbered reflective paths

are also approximately the same as the previous odd-numbered reflective path (i.e., the noise contribution of  $R_{(2)}$  equals  $R_{(1)}$ , and the contribution of  $R_{(4)}$  equals  $R_{(3)}$ ). The reflective path lengths can be calculated as shown in Example 1.

Using the same data as Example 1, the contributions of the remainder reflections can be determined. As stated,  $R_{(2)} \approx R_{(1)}$ , and the contributions are equal.  $R_{(3)}$ , which consists of three short incident/reflection paths (Figure 5-36) and a final long reflective path to the receiver, and its contribution can be calculated as follows.

### Example 2

$$x = ac / (3a + b) = (30)(60)/(90 + 50) = 12.9 \text{ feet}$$

$$y = c - 3x = 60 - 3(12.9) = 21.3 \text{ feet}$$

Also,  $y = bc / (3a + b)$ , which can serve as a check:

$$y = (50)(60) / (90 + 50) = 21.4 \text{ feet}$$

(Slight difference in results of  $y$  is because of rounding.)

$$\text{Three short paths (all equal)} = \sqrt{(x^2 + a^2)} = \sqrt{(12.9^2 + 30^2)} = 32.7 \text{ feet}$$

$$\text{Final reflective path} = \sqrt{(y^2 + b^2)} = \sqrt{(21.3^2 + 50^2)} = 54.3 \text{ feet}$$

$$R_{(3)} = 3(32.7) + 54.3 = 152.4 \text{ feet}$$

$$R_{(3)} \text{ contribution} = 10\log(D / R_{(3)}) = 10\log(66.6 / 152.4) = -3.6 \text{ dBA}$$

$$R_{(4)} \text{ contribution} = R_{(3)} \text{ contribution} = -3.6 \text{ dBA}$$

Close examination of Figure 5-36 indicates that the number of possible reflective paths is limited by  $x$  and the smaller of the half-widths of the soffit or lower deck. By comparing the half-widths of both the soffit and lower deck with calculated  $n(x)$ , where  $n$  is each whole interval of  $x$ , the number of reflection points will become apparent. However, it should be noted that the final reflective path is the  $n$ th + 1 reflective path (in this case,  $n + 1 = 4$ ).

Finally, the results from Examples 1 and 2 can be tabulated in summary form. An example of this format is shown in Table 5-3. All the reflective noise contributions shown are referenced to the undiffracted noise level at the receiver, but at the distance of the diffracted path. Because the reflective contributions are all without diffractions but the noise at the receiver (without reflections) is diffracted, all contributions to the undiffracted noise at the receiver must be normalized. As indicated in the discussion of primary reflection, undiffracted noise can be modeled by placing the receiver in such a position that no diffraction takes place. The previous discussion used undiffracted noise of 70 dBA and diffracted noise (without including reflections) of 60 dBA. The results table reuses these values. In that case, the reference is 70 dBA and all other values are relative to this reference. Also included is the correction for non-perfect

reflections (assumed  $NRC = 0.05$  [Equation 5-4] at each reflection point). Please note that reflective paths 2 and 4 actually have two and four reflection points very close to the source and therefore will be corrected for  $NRC = 0.05$ .

**Table 5-3. Summary of Reflective Noise Contributions and Cumulative Noise Levels**

(1) Reflective Path Number $R_{(n)}$	(2) Contribution Relative to Ref. <sup>a</sup> [ $10\log(D / R_{(n)})$ ]	(3) Correction for $NRC = 0.05(n)$ $10\log(1 - 0.05)$	(4) [(2) + (3)] Adjusted Contribution ( $AC_n$ ) Re: Ref. <sup>a</sup>	(5) Cumulative Noise Level ( $L_n$ ) <sup>b</sup> Re: Ref. <sup>a</sup>	(6) [(5) + Ref. <sup>a</sup> ] Absolute Noise Level
None	-10 dBA	None	0	L = -10 dBA (Given)	60 dBA (Given)
1	-1.8 dBA	-0.2 dBA	$AC_1 = -2.0$ dBA	$L_1 = -1.4$ dBA	68.6 dBA
2	-1.8 dBA	-0.4 dBA	$AC_2 = -2.2$ dBA	$L_2 = +1.2$ dBA	71.2 dBA
3	-3.6 dBA	-0.7 dBA	$AC_3 = -4.3$ dBA	$L_3 = +2.3$ dBA	72.3 dBA
4	-3.6 dBA	-0.9 dBA	$AC_4 = -4.5$ dBA	$L_4 = +3.2$ dBA	73.2 dBA

<sup>a</sup> Ref. = reference of 70 dBA.

<sup>b</sup> Cumulative noise levels in column 5 are calculated as follows:  
 $L_1 = 10\log(10^{L/10} + 10^{AC1/10})$   $L_2 = 10\log(10^{L1/10} + 10^{AC2/10})$   
 $L_3 = 10\log(10^{L2/10} + 10^{AC3/10})$   $L_4 = 10\log(10^{L3/10} + 10^{AC4/10})$

### 5.1.7.7 Minimizing Reflections

When designing reflective parallel noise barriers, it is recommended that a minimum 10:1  $W / H_{AVG}$  ratio is maintained between the two barriers to avoid perceivable barrier performance degradations. Earth berm noise barriers are not reflective and therefore not affected by  $W/H_{AVG}$  ratios of less than 10:1.

Sound absorption has been promoted as a solution for noise reflection issues. As part of an ongoing program, Caltrans considers a variety of proprietary noise barrier products and systems, some of which have sound-absorptive characteristics. For more information on barrier materials and new products, the designer should check with the Caltrans Headquarters Office of Design and Local Programs for availability of approved materials, and the Division of Structures Design to determine which materials have been approved for use on noise barriers. Sound-absorptive materials can be an inherent property of the barrier or added on to an existing barrier (retrofit). The Caltrans new products webpage lists approved noise barrier products. These barrier products include reflective, absorptive, transparent, and bridge-rail-mounted options. The new products webpage is available here:

[http://www.dot.ca.gov/hq/esc/approved\\_products\\_list/](http://www.dot.ca.gov/hq/esc/approved_products_list/)

The amount of noise absorption of the materials is rated by a noise absorption coefficient  $\alpha$ . The coefficient is defined as the ratio of the acoustical energy absorbed by the material to the total energy incident on that material. For any particular material,  $\alpha$  is frequency-dependent, and its value for each specific frequency ranges from 0 (perfect reflector) to 1 (perfect absorber). To rate the overall absorptive characteristics of the material, a measure of the average  $\alpha$  over the frequency range of interest is useful. For traffic noise frequencies, an appropriate measure is the NRC, which is the arithmetic average of  $\alpha$  in four octave bands with center frequencies of 250, 500, 1,000, and 2,000 Hz, calculated as follows:

$$\text{NRC} = (\alpha_{250} + \alpha_{500} + \alpha_{1,000} + \alpha_{2,000})/4 \quad (5-5)$$

If approved absorptive materials are considered, a minimum NRC of 0.85 should be used as a criterion. This value means that 85% of the incident noise energy is absorbed and 15% reflected. For a single reflection, this can only add a maximum of 0.6 dBA to the direct noise level, instead of the theoretical 3 dBA for a perfect reflector (NRC = 0).

## 5.1.8 Miscellaneous Acoustical Design Considerations

There are various other factors that can affect the acoustical performance of noise barriers. Some (maintenance access, emergency access, and drainage openings) are discussed in *Highway Design Manual* Chapter 1100. The criteria in Chapter 1100 are based on actual noise measurements performed by the TransLab in the 1980s. Although the information is mostly useful to the designer of the noise barrier, it is repeated here for the noise analysts because they often need to field questions about the acoustical integrity of the noise barrier's design features. Refer to the Caltrans website for the latest version of the *Highway Design Manual*.

### 5.1.8.1 Maintenance Access behind Noise Barriers

Noise barriers placed within the area between the shoulder and right-of-way line complicate the ongoing maintenance operations behind the noise barrier. From a maintenance perspective, it would be best to place the noise barrier on the right-of-way line, which would avoid access issues and the need of a chain link fence. However, this location may not be

preferable for acoustical reasons, as discussed in Section 5.1.2. If the right-of-way line borders a frontage road or other public easement, access to the strip of land between the barrier and the right-of-way can be provided through gates in the chain link right-of-way fence. If not, access may be provided by offsets in the barrier (Figure 5-37). The acoustical integrity of the noise barrier can be maintained by either providing a solid gate of appropriate material and transmission loss (see Section 5.1.1) to close the opening between the two barriers, or by providing a barrier overlap of two-and-a-half to three times the offset distance without closing the opening (Figure 5-38).

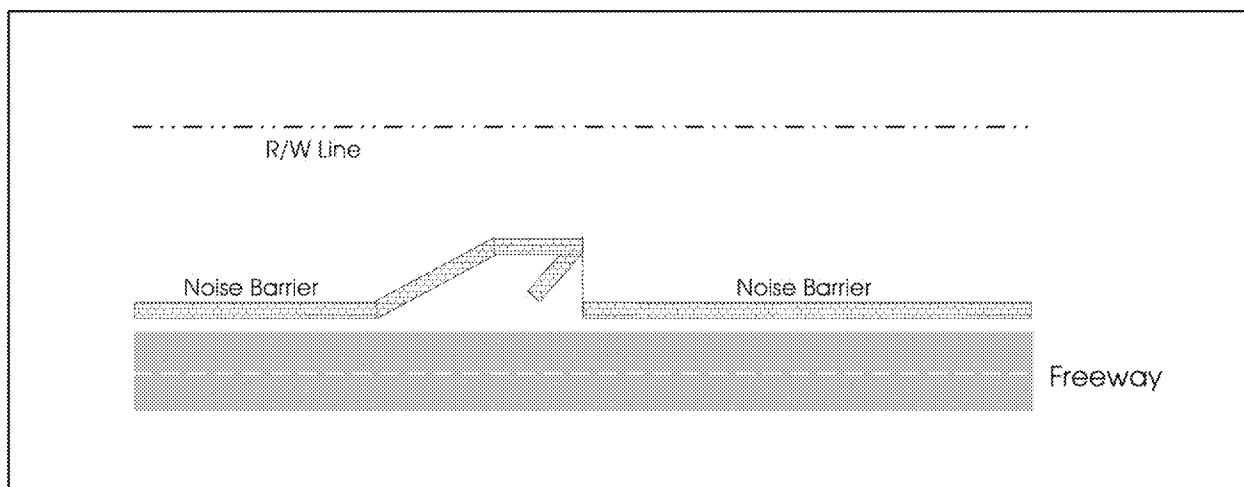

**Figure 5-37.** Barrier Offset with Solid Gate

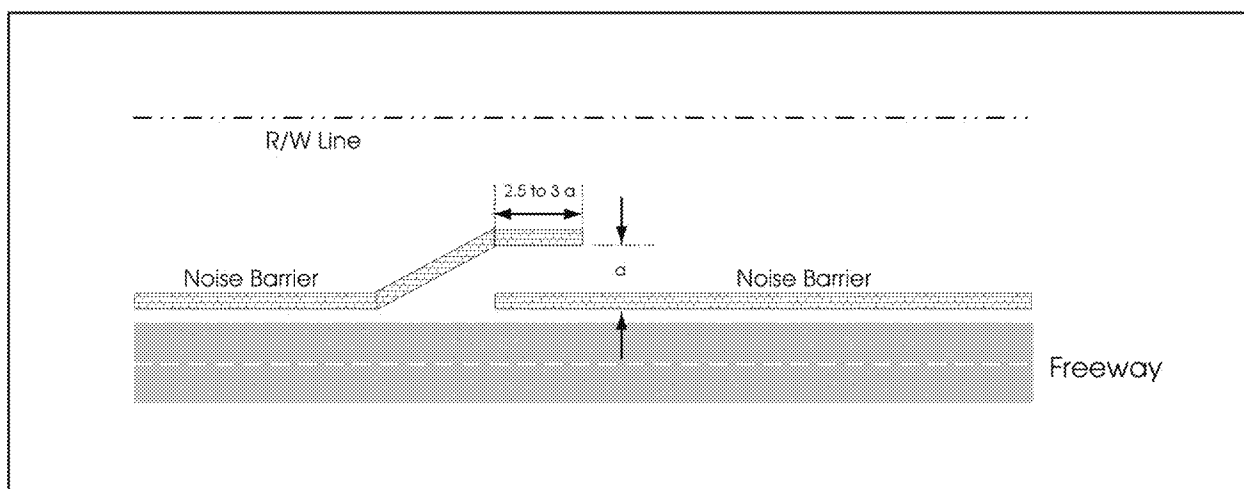

**Figure 5-38.** Barrier Overlap Offset 2.5 to 3 Times the Width of the Access Opening

### **5.1.8.2 Emergency Access Gates in Noise Barriers**

In addition to access gates and openings in noise barriers for routine maintenance, emergency access gates may be constructed to provide access to a freeway when emergency vehicles cannot reach the scene of an accident. The gates are not intended to provide alternate emergency access to adjacent neighborhoods. Small openings in the noise barrier may also be provided to allow fire hoses to be passed through. The number of gates should be minimized, and the gates should be at least 1,000 feet apart. Where possible, the maintenance openings and emergency access gates should be combined in one location. The Division of Structures Design has incorporated the design of the gates in the soundwall details. The fire hose openings should be located as close as possible to the fire hydrants on the local streets. The size and spacing of the openings normally do not compromise the acoustical performance of a noise barrier. Design details of these openings are available from the Division of Structures Design.

### **5.1.8.3 Drainage Openings in Noise Barriers**

Drainage through noise barriers is sometimes required for various site conditions. Depending on size and spacing, small unshielded openings at ground level can be provided in the barriers to allow drainage without compromising the acoustical performance of the barrier. This can be accomplished if the following size and spacing criteria are observed.

- Openings of 8 by 8 inches or smaller if the openings are spaced at least 10 feet on center.
- Openings of 8 by 16 inches or smaller if the openings are spaced at least 20 feet on center and the noise receiver is at least 10 feet from the nearest opening.

The location and size of drainage openings need to be designed based on the hydraulics of the area. The designer should also consider possible erosion that may occur at the drainage openings.

Where drainage requirements dictate openings that do not conform to these criteria, shielding of the opening may be necessary to uphold the acoustical performance of the noise barrier in the vicinity of a receiver. Shield design should be done with consultation of the district hydraulics unit and noise analyst.

#### 5.1.8.4 Vegetation as Noise Barriers

In spite of a general perception of its effectiveness in lowering noise levels, shielding by shrubbery and trees typically used in landscaping along highways provides an imperceptible amount of noise reduction (less than 1 dB) (California Department of Transportation 1995). Such plantings are not effective for reducing highway noise. A possible explanation for the contradiction of objectively measured noise with general perception is that shrubs shielding traffic from the receiver reduce the visual awareness of the traffic. In such cases, the reduction in visual awareness of the traffic is commonly accompanied by a reduction in auditory awareness of the traffic. The role of landscaping and planting in enhancing the aesthetics of a noise barrier and combating graffiti are addressed in the next section.

## 5.2 Non-Acoustical Considerations

Final selections of materials, locations, heights, lengths, and shapes of noise barriers include non-acoustical considerations such as safety and aesthetics. Although the noise analyst is normally not involved with these decisions, the analyst should be aware that recommended acoustical designs of noise barriers are sometimes altered because of non-acoustical considerations.

### 5.2.1 Safety

Safety considerations include lateral clearances, sight distance requirements, and guardrail or safety-shaped barrier requirements. These safety considerations are addressed in *Highway Design Manual* Chapter 1100.

The Division of Structure Design has developed standard plans for noise barriers (soundwalls). Standard plans for soundwalls can be downloaded from the Caltrans website:

[http://www.dot.ca.gov/hq/esc/oe/construction\\_standards.html](http://www.dot.ca.gov/hq/esc/oe/construction_standards.html)

Other designs, retrofit treatments, and alterations to noise barriers should be approved by the Office of Structure Design. Approved commercial noise barrier products including absorptive barriers are listed on the Caltrans website:

[http://www.dot.ca.gov/hq/esc/approved\\_products\\_list/pdf/noise\\_barrier\\_systems.pdf](http://www.dot.ca.gov/hq/esc/approved_products_list/pdf/noise_barrier_systems.pdf)

The standard plans also include designs for gates that provide emergency access to community fire hydrants, emergency access for stranded motorists, and rapid access to accidents, as discussed in Section 5.1.8.

A minimum height criterion of 6 feet for soundwalls in *Highway Design Manual* Chapter 1100 was partially designed to control pedestrian access to the freeway. The online version of the *Highway Design Manual* at the Caltrans website should be checked for the latest changes and referrals.

## 5.2.2 Aesthetics

The visual impact of noise barriers on adjoining communities and motorists is a major consideration in the design of noise barriers. A high noise barrier placed close to single-story residences could result in a visual effect. A high barrier also can create shadows, impede natural airflows, or block panoramic views. *Highway Design Manual* Chapter 1100 outlines maximum recommended heights for noise barriers located at distances of 15 feet or less and more than 15 feet from the traveled way.

In general, visual dominance of high walls near residences is reduced when the soundwall is located at least two to four times its height from the nearest receiver. The visual impact is further softened with berms and landscaping (Figure 5-39). Landscaped earth berms are aesthetically superior to soundwalls and acoustically perform equally or slightly better. However, in many locations, they are not suitable because of space limitations.



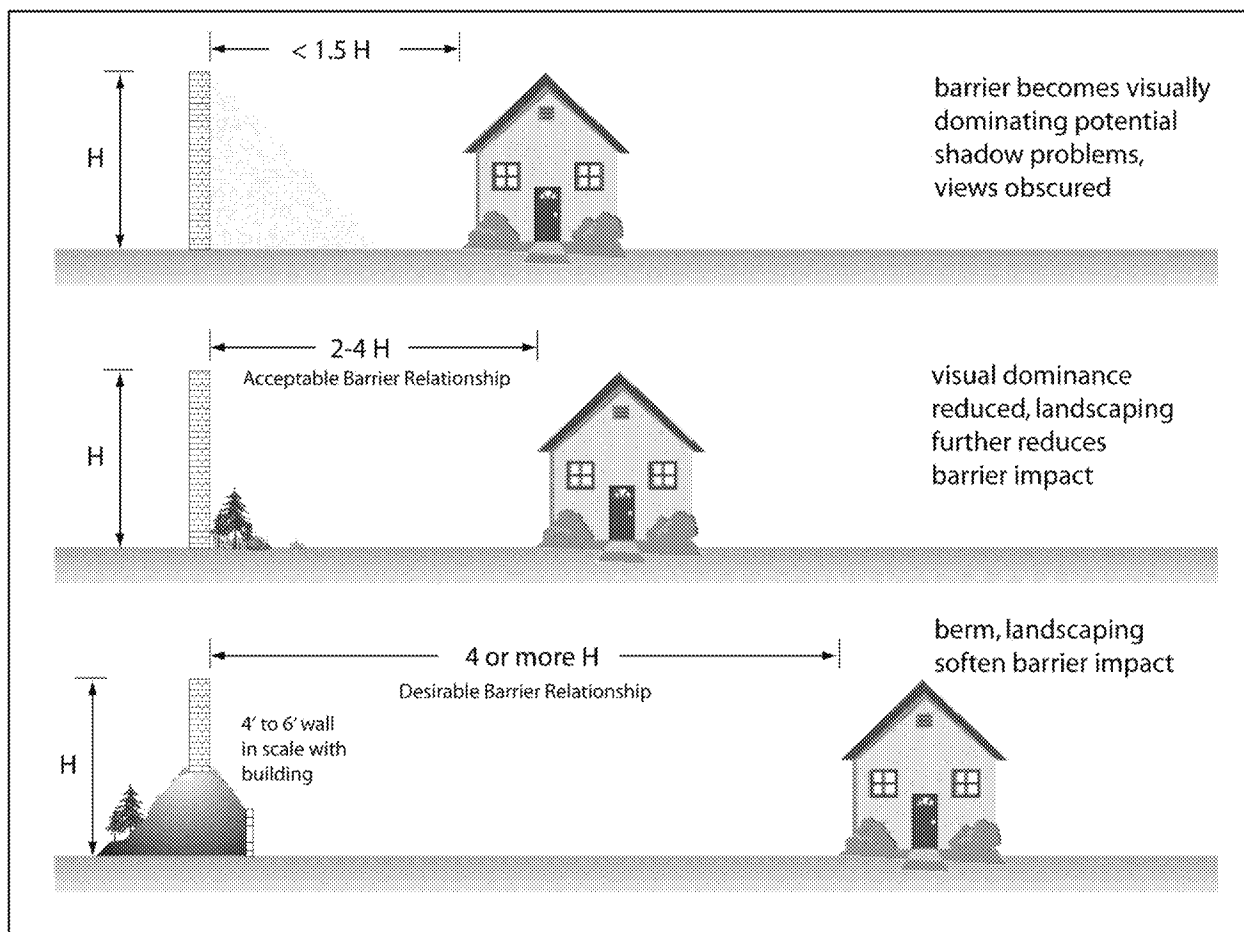

Figure 5-39. Spatial Relationship of Barrier to Adjoining Land Use

Soundwalls should not have abrupt beginnings or endings; they should be tapered or stepped. Aesthetic treatments are normally developed by the Division of Landscaping. If landscaping is to be placed adjacent to the soundwall where it eventually will screen a substantial portion of the wall, only minimal aesthetic treatment is justified.

Walls should reflect the character of the surroundings as much as possible. In cases where the general architecture of a community has a certain character, soundwall material, texture, and color should fit this character at the community side of the wall. Ideally, the community should have some input in the aesthetic design of noise barriers.

On the motorist side of the wall, the emphasis should be on the overall form, color, and texture of the wall. Visual effects on the driver from brick patterns and other forms and shapes should be considered when designing soundwalls. Small details will not be noticed at normal highway speeds. Instead, the emphasis should be on avoiding a tunnel effect through

various forms, and visual treatments. Landscaping can be used effectively to accomplish this goal. As discussed, shrubs and trees used for landscaping along a highway do not provide effective shielding by themselves, but they can enhance the aesthetics of a noise barrier and combat graffiti by denying access to a large smooth surface and reducing its visibility from the highway or community side.

Further guidance on aesthetics can be found in *Highway Design Manual* Chapter 1100. Another useful reference on all aspects of noise barrier design and extensive coverage of aesthetics is the *FHWA Noise Barrier Design Handbook* (Fleming et al. 2011).

## Section 6

# Noise Study Reports

The primary function of a noise study report is to present the methods and results of a traffic noise analysis, as well as the data supporting the conclusions, to a target audience that includes both laypersons and technical noise analysts. To satisfy both audiences, the author can provide a summary for laypersons and decision-makers, and a technical report for experienced readers who desire more detail than what is provided in the summary.

The summary should briefly describe the existing land use and noise environment, project alternatives, future noise environment, traffic noise impacts, and noise abatement and mitigation considered. The technical report needs to fully support the conclusions that are incorporated into the environmental document and should satisfy technical reviewers who wish to assess the validity of the noise study, including methods and assumptions. Sufficient information should be presented to allow any trained noise analyst to reach the same conclusions.

As with all technical environmental studies, the level of effort to be spent on the noise study report needs to correspond to the size and complexity of the project, and degree of controversy surrounding it.

After completion of the noise study report, the noise abatement decision report (NADR) is prepared. The NADR is a design responsibility and is prepared to compile information from several sources. These sources include the noise study report, other relevant environmental studies, and design information. The NADR brings this information together into a single, comprehensive document that is completed before public review of the project. The NADR is prepared before publication of the draft environmental document.

The draft environmental document is the primary means of conveying information on noise impacts and abatement to the public, and reflects conclusions and information contained in the noise study report and NADR.

## 6.1 Outline

Table 6-1 shows an outline for a typical noise study report. Not all reports will need this level of detail. Others may require more because of special circumstances. An annotated noise study report outline has been prepared by Caltrans and is available: <<http://www.dot.ca.gov/ser/forms.htm>>. This outline provide guidance on the contents of noise study reports and provides a template with standard language that can be used a starting point for those who are preparing noise study reports.

**Table 6-1. Noise Study Report Outline**

---

**Summary (or Executive Summary)**

Purpose of Noise Report

Brief Description of the Project

Brief Description of the Land Use and Terrain

Existing Noise Levels (Ambient and Background)

Future Predicted Noise Levels

Traffic Noise Impacts (if Any)

Noise Abatement/Mitigation Considered (Range of Heights, Lengths, Insertion Losses, and Number of Benefited Receivers)

Reasonable Monetary Allowances per Benefited Receiver for Abatement Considered

Areas Where Abatement/Mitigation Is Not Feasible

Construction Noise

**Chapter 1. Introduction**

1. Purpose of Report
2. Background

**Chapter 2. Project Description**

1. Detailed Description of All Project Alternatives
2. Maps Showing Alignment and Profiles

**Chapter 3. Fundamentals of Traffic Noise**

1. Decibels and Frequency
2. Noise Source Characteristics (Vehicles and Roadways)
3. Noise Propagation
4. Perception at the Receiver, A-Weighting, and Noise Descriptors
5. Decibel Scale

**Chapter 4. Federal and State Policies and Procedures**

1. Traffic Noise Analysis Protocol
2. Technical Noise Supplement

**Chapter 5. Study Methods and Procedures**

1. Selection of Receivers and Measurement Sites
2. Field Measurement Procedures (Note: Field Data in Appendices):
  - a. Instrumentation and Setups
  - b. Noise Measurements
  - c. Traffic Counts and Speeds
  - d. Meteorology
  - e. Data Reduction
3. Noise Prediction Method Used: TNM as mandated in 23 CFR 772

**Chapter 6. Existing Noise Environment**

1. Detailed Description of Noise-Sensitive Land Use
2. Maps Showing Receivers and Noise Measurement Sites
3. Table Showing Existing Noise Levels at Receivers:
  - a. Field-Measured Results (Ambient and Background)
  - b. Modeled Results
4. Discussion on Model Calibration (if Appropriate) for Adjusting Modeled Noise Levels (Existing or Future)

**Chapter 7. Future Noise Environment, Impacts, and Considered Abatement/ Mitigation**

1. Discuss Future Traffic Data Assumptions and Site Geometry
2. Table Showing Predicted Noise Levels and Identification of Traffic Noise Impacts, if Any
3. Discussion of Noise Abatement Options
4. Table Showing Future Noise Levels and Insertion Losses (Noise Reduction) for Various Noise Barrier Heights, Lengths, and Locations
5. Table showing top-of-wall elevations as a function of station number
6. Table Summarizing Data Necessary for “Reasonableness” Determination
7. Discussion of Areas Where Abatement/Mitigation Is Not Feasible

**Chapter 8. Construction Noise****Chapter 9. References****Appendix A. Traffic Data****Appendix B. Predicted Future Noise Levels and Noise Barrier Analysis****Appendix C. Noise Barrier Reasonableness Analysis Worksheets****Appendix D. Noise Barrier Analysis****Appendix E. Supplemental Data**

1. Instrumentation, Manufacturer, Model, Type, Serial Number, and Calibration
2. Measurement Site Details and Instrument Setups
3. Measurement Procedures, Duration, and Number of Repetitions
4. Measured Noise Data, Dates, and Times
5. Meteorological Conditions
6. Traffic Counts
7. Data Reduction and Measurement Results
8. Details of Computer Modeling Assumptions, Inputs, and Outputs

## 6.2 Summary

The noise study findings and conclusions should be presented near the front of the noise study report in the form of a summary (sometimes called *Executive Summary*). The summary is extracted from the technical portion of the noise study report. This requires the technical portion to be written first.

The summary should target laypersons and managers who are interested in the findings and conclusions of the noise study but not concerned about all of the technical details. Because the author of the noise study report is usually not the author of the project's environmental document, the summary should be written in such a manner that it can be copied into the environmental document. This will help to reduce misinterpretations, inconsistencies, loss of vital information, and numerical transpositions. The summary should be short, usually no longer than a few pages. The elements mentioned in Table 6-1 should be described briefly. A table listing receivers, existing noise levels, future noise levels without noise barriers, future noise levels with noise barriers (various heights), and insertion loss should be sufficient to summarize the results of the noise study.

## 6.3 Noise Impact Technical Study

The noise impact technical study is the main body of the noise study report. It contains detailed descriptions of why and how the noise study was performed and how the conclusions were reached. Sufficient detail is needed for someone to be able to duplicate the study from the information included in report.

### 6.3.1 Introduction

The introduction should include the purpose of the noise study report, study objectives, background information such as the need for the project and study, and any other general information useful to the understanding of the noise study report.

### 6.3.2 Project Description

The project description should include a detailed description of all project alternatives. There should be enough information for the reader to

understand the project and how it fits into the transportation system of the area. An appropriate location map that shows the alternative alignments studied and their spatial relationship with noise-sensitive receivers such as residences, schools, hospitals, churches, and parks should be included.

### **6.3.3 Fundamentals of Traffic Noise**

A short review of the physical principles of traffic noise at the source and its propagation, as well as subjective human perception, will provide a link for laypersons to understand the technical information. The contents of this section may be in a standard format or tailored to specific studies.

The noise characteristics of vehicles should be described briefly. Vehicle noise emissions increase with speed, and increased traffic volumes increase traffic noise, but it takes a doubling of traffic to increase noise levels by only 3 dB.

Noise propagation (line vs. point source) over acoustically hard and soft ground, effects by meteorological factors such as wind and temperature gradients, and shielding by terrain or noise barriers should be discussed.

Human perception of noise is frequency-dependent, which leads to a discussion on A-weighting, its purpose, and its use. If the character of the noise is unchanged sound level increases or decreases generally are perceived as follows: 3 dBA as barely perceptible, 5 dBA as readily perceptible, and 10 dBA as a doubling or halving of noise. This should be followed with a discussion on commonly used noise descriptors, such as  $L_{eq}(h)$ .

Inclusion of a decibel scale that shows a link between everyday activities and associated noise levels will provide the reader with a scale by which to evaluate the severity of traffic noise.

This discussion does not need to be restricted to the above items. Other topics may be included as appropriate, some of which may be specifically tailored to the nature of the noise study. The information presented in this TeNS may be beneficial in explaining various phenomena. For instance, where controversies surrounding parallel or single noise barrier noise reflections are an issue, it may prove beneficial to include relevant selected text from Section 5.1.7 or 7.1. Text from Section 7.1 may be similarly useful in addressing concerns about the effects of noise barriers on distant receivers.

### **6.3.4 Federal and State Standards and Policies**

This section addresses the applicable federal and state standards and policies. Caltrans noise analysis policies are in the Protocol and *Highway Design Manual*. Federal requirements are identified in 23 CFR 772. State requirements are contained in Streets and Highways Code Section 216. Terms used in the policies and standards should be mentioned in this section including the NAC, definitions of appropriate noise descriptors, and traffic noise impact criteria.

### **6.3.5 Study Methods and Procedures**

Study methods and procedures followed should be identified in the noise study report. This section should describe selecting receivers, noise measurement sites, field measurement procedures, and noise prediction methods (see Sections 3 and 4).

The discussion of selecting the receivers and noise measurement sites should focus on the reasons they were selected. Selections are based on expectations of worst noise impacts, geometry of the project, representativeness, acoustical equivalence, and human use (see Sections 3.2 and 4.3.1). The importance of selecting receivers outside the area of project influence must not be overlooked. These receivers are extremely useful for documenting background noise levels and, after the project is built, guarding against unsubstantiated public claims that noise barriers constructed as part of the project increased noise levels at distant receivers (see Section 7.1.1).

The discussion on field measurement procedures (see Section 3) should include descriptions of instrumentation, setups, noise measurement procedures, traffic counts and speeds, meteorological observations, and data reduction methods. Model calibration procedures (see Section 4.4) should also be discussed.

The appendices to the noise report should indicate the measurement equipment used, calibration information, dates and times of measurements, measured noise data, traffic counts and speeds, meteorological conditions, site topography, and detailed measurement locations. (As a general rule, the microphone locations should be retraceable within 3 feet horizontally, and 1 foot vertically.) If measurements were taken at a time different from the worst noise hour, the adjustment and procedure used (see Section 3.3.1.2), any receivers modeled and calibrated, and any inputs should be shown.



Noise level predictions must be based on the methodology in the FHWA Traffic Noise Model. These and other documents pertinent to the noise study should be referenced as appropriate.

### 6.3.6 Existing Noise Environment

Before traffic noise impacts can be evaluated, detailed knowledge of the existing noise environment is required. A description of the project's surrounding land use (e.g., residential, commercial, undeveloped land, farmland) should be included in this section. The number and types of receptors involved should be reported so that the reader understands the size and characteristics of the area under study. Particularly sensitive land uses should also be pointed out. For undeveloped land, future uses should be included if they are known. For reporting purposes the Protocol requires that at least one receiver be included in an area that is undeveloped. The presence of any other stationary or mobile noise sources (e.g. arterials, airports, railyards) should also be noted.

The general topography surrounding the project and any issues in noise measurements or modeling should be pointed out in this section, especially for complicated or unusual situations. A discussion on background noise levels (i.e., noise levels unaffected by the existing highway) is also appropriate as well as a general description of traffic flow conditions (i.e., traffic level of service). The importance of selecting measurement sites to document background noise levels is discussed in Section 3.1.1.

For each receiver selected for the noise impact analysis, the following should be shown.

- Location or address.
- Type of development.
- Number of units represented by the receiver.
- Land use activity category and NAC.
- Existing noise level results (data logs should be included in the appendices).
- State whether existing noise level was measured or modeled (predicted).
  - If measured, whether measurement was adjusted to worst hour noise (see Section 3.3.1.2).

- If predicted, whether prediction included model calibration (see Section 4.4) (details of the calibration, such as the calibration constant and explanations of why they were excessively large, should be in the appendices).

Table 6-2 suggests how the information might be displayed in tabular form. The format shown is only an example. The information may be presented in other ways as long as the result is clear, concise, and effective.

This section should only show a summary of the results. It is important to mention whether the existing noise levels reflect the worst noise hour or other time periods. The text should include brief discussions of meteorological conditions during measurements and meteorological criteria. Noise measurement data, traffic counts, speeds, meteorological conditions, site locations, and topography should be included in the appendices.

### **6.3.7 Future Noise Environment, Impacts, and Considered Abatement**

This section of the noise study report addresses the future noise environment. A discussion of the assumptions and data used to model predicted noise levels is appropriate. The source of predicted future traffic volumes (e.g., traffic models, assumed level of service [LOS] C or D, design-hour traffic), vehicle mix, and speeds should be included. The actual input and output data should be presented in the appendices.

The predicted results for future noise levels, traffic noise impacts, and considered abatement, if any, should be presented clearly and concisely. It is usually best to display summary information in tables. Examples of presenting predicted noise levels and impacts are shown in Tables 6-3 and 6-4. The table shows receivers, receiver type, location or address, existing noise levels, predicted noise levels, noise increase or decrease, activity category, NAC, and impact type. A project map showing receivers and approximate locations of noise barrier locations considered should be included.

The table showing predicted noise and impact results provides information for discrete receivers. The information must be expanded to include the entire study area. Table 6-2 shows how many units were represented by each selected receiver. This information can be used to identify areas of traffic noise impacts and the acoustical design of noise barriers (e.g., insertion loss, length, and height). For projects where traffic noise impacts

have been identified, heights and lengths of all feasible noise barriers or other abatement measures should be shown, as well as enough information to determine the reasonable noise abatement allowance per benefited residence for each noise barrier and height considered. This allowance is necessary to determine whether abatement measure costs are reasonable. Although noise barriers are normally considered for abatement, other measures may also be considered (see the Protocol) and in some instances might be a better option.

If noise barriers are to be considered for the project, the future noise levels and noise insertion losses for various barrier heights or alternate locations should be provided in tabular form. As stated in Section 1102.3 of the Caltrans *Highway Design Manual* a noise barrier should intercept the line of sight from the exhaust stack of a truck to the receptor. The truck stack height is assumed to be 11.5 feet above the pavement. The receptor is assumed to be 5 feet above the ground and located 5 feet from the living unit nearest the roadway. Table 6-4 provides an example of how this information can be reported.

The procedures for determining the preliminary reasonableness of noise abatement (see the Protocol) require various inputs, most of which have been discussed. Table 6-5 is an example of how this information may be displayed. The fact that barrier heights and locations are preliminary and subject to change should be mentioned.

If appropriate, it should be mentioned that noise barriers under consideration can create their own impacts. Barriers may interfere with the passage of air, interrupt scenic views, or create shadows. They can also create maintenance access challenges, make it difficult to maintain landscaping, create drainage or snow removal issues, and provide pockets for trash to accumulate. In certain circumstances, they may raise concerns about safety by blocking areas from the view of patrolling police. Noise barriers can also raise concerns about traffic safety by reducing stopping or merging sight distance or by reducing errant vehicle recovery room.

It is not uncommon for roadway geometries to change between the time the noise study report is completed and final design. Because calculated barrier attenuation values are directly tied to the geometric relationship between the roadway, barrier, and receivers, it is important to document the top and bottom elevations of noise barriers relative to the elevation of the roadway. Then if geometries change in the final design, an assessment can be made as to the significance of the geometric change relative to calculated barrier attenuation. If the geometric change is large enough it may be necessary to re-run the noise model with the new geometries to ensure that predicted attenuation values are maintained or to re-assess cost reasonableness if attenuation values change significantly.

To document the elevations used in the noise analysis a top-of-wall profile should be provided for each noise barrier evaluated. The elevation profile should be provided for the minimum height wall that breaks the truck stack line-of-sight and the wall height that meets the reasonableness design goal (7 dB noise reduction at one or more benefited receiver). It may also be useful to include the elevation of the base of the barrier and outside travel lane. Table 6-6 is an example of how roadway and barrier elevations can be reported.

### 6.3.8 Construction Noise

Construction noise impacts and likely abatement measures (if necessary) should be discussed briefly. Unless the project involves construction activities that are likely to generate unusually high noise levels such as pile driving or pavement breaking, the discussion should be concise. Detailed discussions of typical construction equipment noise levels are probably not necessary unless the project involves unusually sensitive receptors or nighttime work or if the project is controversial. Caltrans Standard Specification Section 14-8 should be discussed. It states the following.

- Do not exceed 86 dBA  $L_{max}$  at 50 feet from the job site activities from 9 p.m. to 6 a.m.
- Equip an internal combustion engine with the manufacturer-recommended muffler. Do not operate an internal combustion engine on the job site without the appropriate muffler.

Procedures for analysis, monitoring, and abatement of construction noise can be found in Section 7.5.

### 6.3.9 References

Typical references may include 23 CFR 772, *FHWA Highway Traffic Noise: Analysis and Abatement Guidance* (December 2011), the Protocol, *Highway Design Manual* Chapter 1100, FHWA-PD-96-009 and -010, DOT-VNTSC-FHWA-98-1 and -2, and other appropriate documents.

**Table 6-2. Existing Noise Levels (Example)**

Receiver	Location or Address	Type of Development	Units Represented	Noise Abatement Category and Criterion	Existing Worst Hour Noise Level, (dBA- $L_{eq}[h]$ )	Noise Level Measured <sup>a</sup> or Modeled <sup>b</sup> ?
1	1234 Elm Street, backyard, center of patio (first-row residence)	Residential	15	B (67)	74	Measured
2	4321 Main Street, 5 feet from façade (first-row residence)	Residential	9	B (67)	75	Measured
3	2336 Elm Street, center of backyard (first-row residence)	Residential	24	B (67)	73	Modeled
4	3538 Elm Street, center of backyard (first-row residence)	Residential	18	B (67)	74	Modeled
5	1212 Church Street, 10 feet north of bottom front step	Church	1	C (67)	68	Measured
6	1723 Oak Street, center of front lawn (0.25 mile from the freeway, background noise level)	Residential	24	B (67)	56	Measured
7	1052 Sycamore Drive, middle of cul-de-sac, (0.25 mile from the freeway, background noise level)	Residential	30	B (67)	55	Measured

<sup>a</sup> Unless otherwise indicated, all measurements shown reflect worst hour noise levels (i.e., they were either measured during the noisiest hour [see Section 3.3.1.1] or were adjusted to worst hour traffic characteristics [see Section 3.3.1.2]).

<sup>b</sup> Unless otherwise indicated, modeled receivers include a calibration constant (see Sections 3.1.2, 4.3.3, and 4.4).

**Table 6-3. Predicted Traffic Noise Impacts (Example)**

Receiver	Type, Location, or Address	Existing Noise Level (dBA- $L_{eq}[h]$ )	Predicted Noise Level (dBA- $L_{eq}[h]$ )	Noise Increase (+) or Decrease (-)	Activity Category and NAC, ( $L_{eq}[h]$ )	Impact Type <sup>a</sup>
1	1234 Elm Street, backyard, center of patio (first-row residence)	74	75	+1	B (67)	A/E
2	4321 Main Street, 5 feet from façade (first-row residence)	75	76	+1	B (67)	A/E
3	2336 Elm Street, center of backyard (first-row residence)	73	74	+1	B (67)	A/E
4	3538 Elm Street, center of backyard (first-row residence)	74	75	+1	B (67)	A/E
5	1212 Church Street, 10 feet north of bottom front step	68	69	+1	C (67)	A/E
6	1723 Oak Street, center of front lawn (0.25 mile from freeway, background noise level)	56	56	0	B (67)	None
7	1052 Sycamore Drive, middle of cul-de-sac (0.25 mile from freeway, background noise level)	55	55	0	B (67)	None

**Table 6-4.** Noise Abatement Predicted Noise Levels and Insertion Loss (dBA) for Soundwall 1 at Right-of-Way (Example)

Receiver	Without Wall	With Wall											
		Height = 6 feet		Height = 8 feet		Height = 10 feet <sup>a</sup>		Height = 12 feet		Height = 14 feet		Height = 16 feet	
		L <sub>eq</sub> (h)	Ins. Loss	L <sub>eq</sub> (h)	Ins. Loss	L <sub>eq</sub> (h)	Ins. Loss	L <sub>eq</sub> (h)	Ins. Loss	L <sub>eq</sub> (h)	Ins. Loss	L <sub>eq</sub> (h)	Ins. Loss
1	75	70	5	69	6	68 <sup>a</sup>	7	66	9	65	10	64	11
2	76	70	6	69	7	68 <sup>a</sup>	8	67	9	65	11	64	12
3	74	70	4	69	5	68 <sup>a</sup>	6	66	8	65	9	63	11
4	75	70	5	69	6	68 <sup>a</sup>	7	66	9	65	10	64	11
5	69	65	4	64	5	63 <sup>a</sup>	6	61	8	60	9	59	10
6	56	56	NA <sup>b</sup>	56	NA <sup>b</sup>	56	NA <sup>b</sup>	56	NA <sup>b</sup>	56	NA <sup>b</sup>	56	NA <sup>b</sup>
7	55	55	NA <sup>b</sup>	55	NA <sup>b</sup>	55	NA <sup>b</sup>	55	NA <sup>b</sup>	55	NA <sup>b</sup>	55	NA <sup>b</sup>

<sup>a</sup> Breaks line of sight between 11.5-foot truck stack and 5-foot-high receiver per Section 1102.3 of the *Highway Design Manual*.

<sup>b</sup> NA = not applicable (no barrier considered).

**Table 6-5. Data for Reasonableness Determination (Example)**

Predicted without Soundwall <sup>a</sup>						
Soundwall	Absolute Noise Level (L <sub>eq</sub> [h], dBA)	Build vs. No Build (dBA)				
SW-1	75	+1				
SW-2	74	+1				
<sup>a</sup> At critical receivers.						
Predicted with Soundwall <sup>a</sup>						
Soundwall	Height = 6 feet	Height = 8 feet	Height = 10 feet	Height = 12 feet	Height = 14 feet	Height = 16 feet
<b>SW-1</b>						
Insertion Loss (dBA)	5	6	7	9	10	11
Benefited Residences	24	24	24	48	72	96
Reasonable Allowance Per Benefited Residence	\$55,000	\$55,000	\$55,000	\$55,000	\$55,000	\$55,000
<b>SW-2</b>						
Insertion Loss (dBA)	4	5	6	8	9	11
Benefited Residences	0	24	24	48	48	96
Reasonable Allowance Per Benefited Residence	Not Feasible	\$55,000	\$55,000	\$55,000	\$55,000	\$55,000
<sup>a</sup> At critical receivers.						



**Table 6-6. Roadway and Barrier Geometries (Example)**

Barrier ID	Station	Elevation of Outside Lane (feet)	Elevation of Wall Base (feet)	Elevation of Top of 6 ft Wall	Elevation of Top of 8 ft Wall	Elevation of Top of 10 ft Wall <sup>a</sup>	Elevation of Top of 12 ft Wall	Elevation of Top of 14 ft Wall	Elevation of Top of 16 ft Wall
SW-1	100+00	1255	1258	1264	1266	1268	1270	1272	1274
	100+25	1256	1259	1265	1267	1269	1271	1273	1275
	100+50	1258	1261	1267	1269	1271	1273	1275	1277
	100+75	1257	1260	1266	1268	1270	1272	1274	1276
	200+00	1255	1258	1264	1266	1268	1270	1272	1274
	200+25	1254	1257	1263	1265	1267	1269	1271	1273
	200+50	1252	1255	1261	1263	1265	1267	1269	1271
	200+75	1251	1254	1260	1262	1264	1266	1268	1270
SW-2	300+00	1251	1252	1258	1260	1262	1264	1266	1268
	300+25	1253	1254	1260	1262	1264	1266	1268	1270
	300+50	1254	1255	1261	1263	1265	1267	1269	1271
	300+75	1255	1256	1262	1264	1266	1268	1270	1272
	300+00	1256	1257	1263	1265	1267	1269	1271	1273
	300+25	1255	1256	1262	1264	1266	1268	1270	1272
	300+50	1254	1255	1261	1263	1265	1267	1269	1271
	300+75	1253	1254	1260	1262	1264	1266	1268	1270

<sup>a</sup> Breaks line of sight between 11.5-foot truck stack and 5-foot-high receiver per Section 1102.3 of the *Highway Design Manual*.

## 6.4 Appendices

Any details that would support the conclusions of the noise study report should be included in the appendices, such as instrumentation used, calibration data, field measurement data (e.g., noise, traffic, weather, dates, times, personnel), site details (e.g., plan views, cross sections), computer modeling inputs, and model results. If the analysis includes model calibrations (see Section 4.4), they should be shown in simple table form (see Table 6-7 for an example). The appendices should fill in all details that are not in the main report so the analysis could be repeated by an independent analyst.

**Table 6-7. Model Calibration (Example)**

Receiver	Measured Noise Level (dBA- $L_{eq}$ [h])	Calculated Noise Level* (dBA- $L_{eq}$ [h])	Calibration Constant (dBA)
1	68	70	-2
2	66	69	-3
3	70	71	-1
4	69	72	-3

\*Calculated noise level = noise model result (see Section 4.4.1.1)

If measurements were taken at a time different than the worst noise hour, the adjustment and procedure used (see Section 3.3.1.2), any receivers modeled and calibrated, and any inputs should be shown.

The appendices are a good place to describe issues encountered during the noise study, such as difficulties of site accessibility (include a map of the access route) or contaminating noise sources, such as barking dogs, air conditioners, pool equipment, children's playgrounds, nearby construction, and aircraft. Such information may be useful if additional study or analysis is required.

## Non-Routine Considerations and Issues

Sections 2 to 6 address the routine phases of Caltrans highway noise fieldwork and analyses. The subjects in this section are considered non-routine. Because Caltrans is occasionally involved in these special situations, they are included to round out the knowledge base of the Caltrans noise analysts or other interested party. The subjects addressed in this section are listed below.

- 7.1: Noise Barrier Issues
- 7.2: Sound Intensity and Power
- 7.3: Pavement Noise
- 7.4: Insulating Facilities from Highway Noise
- 7.5: Construction Noise Analysis, Monitoring, and Abatement
- 7.6: Earthborne Vibrations
- 7.7: OSHA Noise Standards
- 7.8: Effects of Transportation and Construction Noise on Marine Life and Wildlife (Bioacoustics)

### 7.1 Noise Barrier Issues

This section discusses some challenging issues and non-routine considerations related to noise barriers. Noise barriers are generally considered beneficial for residents near a freeway. However, there have been claims about perceived noise increases at distances farther than those for which the noise barriers were designed. This issue involves complex relationships between highway and barrier configurations, intervening terrain, receiver location, and atmospheric influences. This section discusses what Caltrans and others have found about this issue and suggests ways to study the effects of noise barriers on distant receivers. Some elements of this discussion involve routine considerations addressed in Section 5.

The effectiveness of vegetation typically used in highway landscaping in reducing noise is also discussed. This issue occasionally surfaces when trimming or removal of shrubs and trees by Caltrans maintenance personnel triggers complaints of perceived noise increases.

## **7.1.1 Effects of Noise Barriers on Distant Receivers**

The public and media in California have on occasion raised concerns that noise barriers increase noise levels at distances of up to 3 miles. The alleged increases were attributed to certain site geometries, noise barrier configurations, intervening terrain, and interacting meteorology. Continuing research by Caltrans and others has provided some answers to these concerns. However, there is a continued need for field research to verify prediction algorithms in prediction models for distances more than 500 feet, alter them if needed, and investigate conditions that lead to any newly identified concerns. This section discusses what Caltrans and others have found.

### **7.1.1.1 Background**

Normally, noise barriers are designed for residences and noise-sensitive receptors located adjacent to a highway, and their effects are generally limited to receivers within about 500 feet of the highway. With few exceptions, there is little disagreement that properly designed noise barriers reduce highway noise within this distance, except for the limited conditions described in Section 5.1.7. Noise prediction models have not been adequately validated for distances beyond 500 feet. Caltrans' *Distance Limits for Traffic Noise Prediction Models* (2002) discusses the reasons for the distance limits. However, if there is a reasonable expectation that noise impacts would extend beyond 500 feet those impacts must be evaluated. This may require engineering judgment and supplemental noise measurements to determine impacts.

With the proliferation of noise barriers in California, public concern has emerged that under certain conditions of topography and meteorology noise barriers can increase noise levels at receivers located from 0.25 to 2 miles from freeways. To date, the concerns have been based on subjective perception only. No objective evidence based on noise measurements has been advanced that noise barriers increase noise levels at any distance or under any conditions other than under the limited conditions described in Section 5.1.7. As indicated, present noise prediction models are not reliable to accommodate distances more than

500 feet. In addition, noise prediction models are unable to predict meteorological effects, which play an increasingly important role in observed noise levels with distance, independent of the nature and strength of their source.

The concerns raised by the public, primarily in the San Francisco Bay Area and Los Angeles area, include all three possible categories of source, barrier, and receiver configurations.

- Reflective noise barriers on the sides of highways opposite from those of the receivers (i.e., highways between barriers and receivers).
- Parallel reflective noise barriers on each side of highways.
- Noise barriers between highways and receivers.

The first two issues involve reflective noise of single and parallel barriers, discussed in Section 5.1.7. The third, however, deals with diffracted noise. All three issues of concern involve long noise propagation distances, which are difficult to study because of the numerous variables in topography and meteorology. Caltrans' experience has been that atmospheric conditions can cause measured noise levels at those distances to fluctuate by more than 10 dBA, with or without noise barriers.

Atmospheric refraction is the principal atmospheric process responsible for these fluctuations. A vertical gradient of either temperature or wind velocity produces a corresponding vertical gradient of sound velocity. This causes sound waves to refract (bend) upward or downward. Upward refraction occurs during sound propagation in an upwind direction or temperature lapse conditions (air temperatures decreasing with height). This tends to send noise skyward, leaving a noise shadow near the ground and thereby reducing noise levels. Downward refraction occurs during sound propagation in a downwind direction or in temperature inversions (temperature increasing with height above the ground). Downward refraction tends to send skyward noise down, concentrating noise near the ground, thereby increasing noise levels. Both upward and downward refraction occurs with and without noise barriers. Atmospheric refraction of sound waves is discussed in Section 2.1.4.3.

### **7.1.1.2 Results of Completed Studies**

Caltrans and its consultants and others have performed elaborate research-level studies concerning noise from highways at adjacent and distant receivers, with and without noise barriers for the three barrier configurations mentioned in Section 7.1.1.1 above. It is not the intent of this section to discuss these studies in detail, only to mention their

combined results. The studies were performed along the following routes: Interstate (I-) 405 in Los Angeles, various locations on I-680 and I-80 in the Bay Area, and one along State Route (SR) 99 in Sacramento. These studies followed the general guidelines and criteria outlined in Caltrans' *General Guidelines for Studying the Effects of Noise Barriers on Distant Receivers* (1998). The John A. Volpe National Transportation Systems Center (VNTSC) in Cambridge, Massachusetts, performed two similar studies at Dulles International Airport near Washington, DC, and along I-495 near Baltimore for parallel noise barriers. In addition to the research studies, Caltrans has gathered numerous anecdotal data during routine project studies.

In each research study, before- and after-noise barrier measurements were carefully matched by wind speed, wind direction, temperature, relative humidity, and temperature gradients with height above the ground. All measurements were also normalized for traffic variations. Brief summaries of results of the studies are provided below.

### **Study Results for Single Barrier on the Opposite Side**

The results of studies involving noise level increases for single barriers on the opposite side of a highway in simple terrain, as discussed in Section 5.1.7.2, agreed remarkably with the theoretical calculations shown in the same section, particularly in Figure 5-26. For distances of 50 to 100 feet, the increases were generally 0 to 1 dBA. At 400 feet, the measured results were a 2.4-dBA increase as calculated. For longer distances, the increases were difficult to discern with accuracy but never more than 3 dBA, even in complex terrain as discussed in Section 5.1.7.2.

### **Study Results for Parallel Barriers**

The results of studies involving parallel noise barriers (i.e., one on each side of the highway), as discussed in Section 5.1.7.4, showed degradations in performance of each barrier because of multiple reflections between two reflective barriers. The degradations appeared to increase with distance from and height above the highway/barrier configuration. Degradations also appeared to be a function of the W/H ratio, discussed in Section 5.1.7.4 and depicted in Figure 5-33. The VNTSC study at Dulles International Airport concluded that the maximum degradation at a 6:1 W/H ratio was 6 dBA at distances for which noise barriers are typically designed. At another location near Baltimore, a maximum degradation of 2.8 dBA was measured by VNTSC for a 9:1 W/H ratio. Caltrans measured a maximum degradation of 1.4 dBA for a W/H ratio of 15:1 along SR 99.

Almost all parallel barrier configurations in California have a W/H ratio of at least 10:1, and most are about 15:1. Based on the studies by VNTSC and Caltrans, Caltrans Highway Design Manual Chapter 1100 advises a minimum W/H ratio of 10:1 or more to avoid degradations of 3 dBA or more. Please note that degradation in barrier performance does not indicate an increase in noise level above that without a noise barrier. Instead, it reduces the effectiveness of each barrier on each side of the highway.

Studies along I-680 and I-80 in the Bay Area also showed no measurable noise increase at receivers 0.25 to 2 miles from the highway and barriers.

### **Study Results for Receiver behind Single Barrier**

For receivers behind a single barrier, field studies indicate that barriers are effective within about 330 feet of a highway. Caltrans has collected an abundance of data in research and routine studies over the years to substantiate this claim.

Caltrans has also experienced, in the course of many measurements, that beyond 330 feet or so from a highway, traffic noise levels often approach background levels (the noise levels associated with normal day-to-day activities in the community). Although soundwalls cannot attenuate noise below these levels, Caltrans has never experienced noise increases (above no-barrier noise levels) at any distance behind noise barriers. However, some people continue to believe that noise barriers will increase noise levels at distant receivers behind a barrier.

Explanations have sometimes centered on noise waves “going over the wall and coming back to the ground.” This is called diffraction and is actually responsible for noise attenuation, rather than an increase in noise, when compared to the direct noise received without a noise barrier, as explained in Sections 2, 4, and 5.

Another popular “explanation” for perceived noise increase from soundwalls is that the soundwall “lifts” the noise over tiers of homes that normally would shield the receiver. A soundwall will elevate the noise source over tiers of homes no more than the intervening homes do. Soundwalls in California are generally limited in height to 16 feet, approximately equal to the average height of residential development.

There generally is a loss of “ground effect” behind a noise barrier. Without a noise barrier, the direct path of the traffic noise to the receiver travels closer to the ground than after a noise barrier is built. Noise waves close to the ground are subject to excess attenuation because of absorption

by the ground. Therefore, when a noise barrier is built, there is a trade-off between barrier attenuation (a decrease in noise) and a loss of excess attenuation.

The net reduction of noise from barrier attenuation and loss of excess attenuation is called barrier insertion loss (see Section 5.1.5). Close to a barrier, the barrier attenuation benefit far outweighs the loss of excess attenuation. At farther distances, however, barrier attenuation diminishes while the cumulative effects of the loss of excess attenuation increase. Caltrans acoustical design procedures for noise barriers take these factors into consideration by applying different noise dropoff rates to with- and without-noise barrier cases. If these drop-off rates were kept constant and applied to long distances, there would be a distance at which the loss in ground effect would eventually exceed the barrier attenuation.

Extensive amounts of field data gathered during a Caltrans noise propagation research project show that differences between excess attenuation rates of elevated sources (e.g., truck stacks, noise diffracted over a noise barrier) and those close to the ground (e.g., tire noise) diminish after few hundred feet or so. The findings can be applied to noise barriers, which in essence “elevate” the source. The cumulative effect of decreasing differences in elevated and near-ground excess attenuation rates with distance appear to be at a maximum at about 200 to 300 feet behind the barrier, where the effect of the differences is the greatest. At greater distances, the differences in elevated and near-ground noise levels appear to become smaller until they disappear at some distance beyond about 400 feet.

Questions have also been raised at times about whether noise “redirected” by noise barriers “bounces off” temperature inversion layers. Redirections on the scale being discussed involve a maximum of 16-foot-high noise barriers and a distance of 0.25 mile or more, are less than 1 degree, and therefore are negligible. Studies under these conditions have confirmed that the difference between barrier and no barrier was not measurable although the noise levels were considerably higher.

After years of research and field measurements under controlled conditions, Caltrans has found no objective evidence that noise levels increase perceptibly because of noise barriers. It is widely accepted by acousticians that normal human ears can barely perceive 3-dBA changes in traffic noise levels when the frequency content of the noise has not changed. Such an increase in noise levels from noise barriers has never been measured.



### 7.1.1.3 Studying the Effects of Noise Barriers on Distant Receivers

Allegations of noise barriers increasing noise levels at distant receivers based on perception only are unreliable at best. With possible noise fluctuations of more than 10 dBA from meteorological factors alone, people making such claims must not only remember the noise levels before the barrier, but also have knowledge of the meteorological conditions associated with those noise levels. To confirm whether noise barriers do increase noise levels in some instances, a complex before- and after-barrier field study must be undertaken.

Before- and after-noise barrier noise measurements do not adequately address the previous issues unless the measurements are carefully matched by before- and after-barrier conditions of meteorology, traffic, and topography. These types of studies are not routine. Technical Advisory, Noise, TAN-98-01-R9701 *General Guidelines for the Effects of Noise Barriers on Distant Receivers*, November 30, 1998, provides guidelines and criteria for conducting such studies. The advisory is available on the website of Caltrans Division of Environmental Analysis, Noise and Vibration Studies (<http://www.dot.ca.gov/hq/env/noise/index.htm>).

Procedures for measuring the performance of noise barriers including parallel barriers are provided in the 2009 version of TeNS.

### 7.1.2 Shielding Provided by Vegetation

No discussion on noise barriers is complete without mentioning the shielding effectiveness of trees, shrubs, and other vegetation typically used for landscaping along highways. Caltrans research on the shielding effectiveness of such vegetation at three different sites in late 1980s and early 1990s concluded that the mean noise reduction was less than 1 dBA, and ranged from 0 dBA to less than 3 dBA (California Department of Transportation 1995). The research further concluded that such vegetative barriers were not an effective measure to reduce highway traffic noise on a routine basis.

However, Caltrans receives complaints of noise increases when Caltrans maintenance personnel trim shrubs and bushes along highways. The most likely explanation for the increase in noise complaints is more related to visual aspects than noise. When shrubs shield traffic from the view of residences, the awareness of the traffic is reduced (i.e., “out of sight, out of mind”). When the vegetation is trimmed or eliminated, the adjacent residents will be able to see the traffic and will be reminded of the noise.

In some cases, residents complaining about ineffective noise barriers have been satisfied when noise barriers have been combined with trees, shrubs, or ivy. Although noise did not noticeably decrease in those cases, the aesthetics of the barriers were improved. Early community acceptance studies have indicated a correlation between barrier acceptance and perceived effectiveness in reducing noise. Therefore, the use of vegetation with noise barriers can be beneficial by improving community acceptance and perceived effectiveness.

As discussed above wind can cause sound waves to refract (bend) upward or downward. When wind is blowing from a source to a receiver downward refraction can increase the sound energy received at the receiver. When a barrier is located between the source and the receiver downward wind refraction can reduce the affective noise reduction provided by the barrier. Research conducted by University Ghent in Belgium (Renterghem and Botteldooren 2008) studied how a tree canopy between the barrier and the receiver affects the degradation of barrier performance from downwind refraction. The study concluded that the presences of a row of trees between a barrier and receiver can provide an important improvement in downwind noise barrier performance up to a distance of 30 times the noise barrier height. Coniferous trees were found to be the most effective in this regard. Other references indicate that 100 horizontal feet of tall grass and thick shrubbery can provide up to 5 dB of additional attenuation and 100 feet of dense woods can provide up to 2 dB of additional attenuation (Hoover & Keith 2000).

## 7.2 Sound Intensity and Power

This document has consistently described the amplitude of sound at a specific location in terms of sound pressure level or noise level. This is also the case for all noise standards, criteria, and descriptors mentioned in this document. In fact, SPL is used in virtually all environmental noise studies for two primary reasons: 1) it is easiest to measure, and 2) it best describes the impact at the receiver.

However, it is important for the noise analyst to know that there are other ways to express sound amplitude. Although considerably more difficult to measure, sound intensity and sound power often provide more useful information about noise sources than sound pressure level. Caltrans has begun using sound intensity in pavement noise studies, and future plans call for other uses to locate and map specific locations of vehicle noise subsources. This section briefly discusses sound power and intensity to broaden the knowledge of noise analysts who may in the future be involved with sound intensity or sound power studies.

## 7.2.1 Sound Power

Sound pressure level describes a local condition. When the noise from a certain source is measured, such as a truck, in terms of sound pressure level, the information is incomplete without knowing the distance, nature, and radiation pattern of the source, intervening terrain, obstacles, reflections, and atmospheric conditions. A change in one or more of these factors will probably change the sound pressure level.

Sound power is a property of the noise source and is independent of the factors influencing sound pressure. Knowing the sound power of a noise source, the sound pressure level can be calculated under a variety of conditions and at different locations. The sound power of a source is a constant. Power is a rate of energy, or the amount of energy produced each second. Energy is force times distance, most commonly expressed as newton meters (Nm), with newton (N) being the unit of force. A force of 1 N is the force required to accelerate 1 kilogram 1 meter per second per second. If sound power is the rate of energy flow, the units are Nm/s, or watts (W).

Sound power may be visualized as the wattage of a light bulb and sound pressure level as the amount of light received by a reader in a room. The latter would depend on many factors, such as the power of the light bulb, distance from the light bulb, shadows from obstacles between the light bulb and reader, and reflections from walls.

From Section 2.1.3.2, sound pressure level is expressed in decibels, and 1 dB is defined as follows:

$$10\log_{10}(P_1 / P_0)^2 \quad (7-1)$$

Where:

$P_1$  = the sound pressure

$P_0$  = a reference pressure of 20  $\mu$ Pa

Pascal is the unit of pressure (force per unit area); 1 Pa = 1 N/m<sup>2</sup>. Sound power may similarly be expressed in decibels. The definition of a sound power level ( $L_W$ ) is:

$$L_W = 10 \log_{10}(W_1 / W_0) \quad (7-2)$$

Where:

$$W_0 = 10^{-12} \text{ W}$$

$W_1$  = total acoustic power

$L_W$  = sound power level in decibels

Sound pressure level should actually be referred to as  $L_p$ , although in environmental noise just  $L$  (e.g.,  $L_{eq}$ ) has normally been used. Using decibels in both sound power and sound pressure levels can be confusing. To avoid confusion, the international standard ISO 9296 requires documentation of sound power ratings in units of bels (B) rather than decibels. However, in the United States, decibels are often also used for sound power levels. In any case, the descriptors should be clearly noted whether they are sound power level or sound pressure level units. If a quantity is expressed in bels,  $1 \text{ B} = 10 \text{ dB}$ .

Sound power cannot be measured directly. However, it can be calculated from sound intensity, which can be measured. One practical use of sound power level is rating product noise from hair dryers to refrigerators.

## 7.2.2 Sound Intensity

Sound intensity is a measure of a directional rate of energy flowing through a unit of area. The units of sound intensity are watts per square meter ( $\text{W}/\text{m}^2$ ) and can be expressed in decibels RE: 1 picowatt (pW) per  $\text{m}^2$  ( $1 \text{ pW} = 10^{-12} \text{ W}$ ). This implies that if the entire measurement area around a source is known, its sound power can be calculated if the mean sound intensity for the measurement area is known. The measurement area (usually hemispherical) around a source increases with distance, and because sound intensity decreases with increasing area, sound power remains constant at any distance. To reduce the influence of background noise, sound intensity measurements are taken close to the source. Caltrans commonly uses on-board sound intensity (OBSI) measurements to characterize sound generated by various types of pavement. OBSI measurements are discussed in more detail in Section 7.3 below.

The sound intensity level ( $L_I$ ) is calculated as follows:

$$L_I = 10 \log_{10}(I_1 / I_0) \quad (7-3)$$

Where:

$L_I$  = sound intensity level in decibels

$I_1$  = sound intensity of interest in  $W/m^2$

$I_0$  = reference intensity of  $10^{-12} W/m^2$

The sound intensity of interest ( $I_1$ ) in  $W/m^2$  can be calculated as follows:

$$I_1 = I_0 * 10^{(L_I/10)} \quad (7-4)$$

Sound intensity ( $I$ ) is the product of sound pressure ( $P$ ) and particle velocity ( $v$ ):

$$I = P * v \quad (7-5)$$

Sound pressure is measured in pascals ( $N/m^2$ ). Particle velocity is measured in meters per second (m/s). Therefore, the product of sound pressure and particle velocity yields  $W/m^2$  ( $N/m^2 * m/s$ ). In Section 2.1.3.1, it is explained briefly that particle velocity is the (back and forth) movement of air molecules. In Figure 2-2, it was shown that the motion is  $90^\circ$  out of phase with the fluctuating sound pressure. When the sound pressure is 0, the particle velocity is at its maximum either in a positive (away from the source) or negative (toward the source) direction.

A sound field includes both sound pressure and particle velocity and is therefore described by sound intensity, which includes amplitude and direction. Where sound pressure fluctuations are easy to measure with a sound level meter, the measurement of particle velocity requires more sophisticated instrumentation.

Sound intensity is most commonly measured with a pair of phase-matched microphones facing each other at a fixed distance apart (Figure 7-1). This two-microphone sound intensity probe measures only the total sound intensity traveling parallel to the microphones' axis and is therefore highly directional. If the probe is pointed at the source (Microphone 1 toward the source and Microphone 2 away from the source) the sound intensity is positive. If the probe is pointed away from the source, the sound intensity will be negative. Because of this directional characteristic, sound intensity is useful in measuring and mapping sound fields around sound sources. The reference point of a sound intensity probe is halfway between the diaphragms of the two microphones facing each other, and the reference direction is along the axis of the microphones.

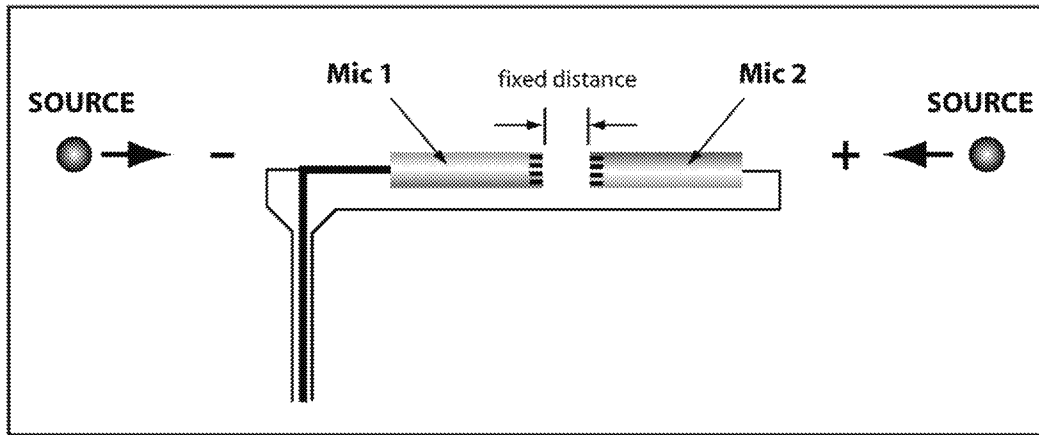

**Figure 7-1.** Schematic of a Sound Intensity Probe

Other sound intensity probes include a two-microphone, side-by-side system. This type of probe is aimed at 90° to the source and relies on “grazing” type microphones, which are sensitive to sound pressures directed parallel to the membranes, instead of perpendicular (Figure 7-2).

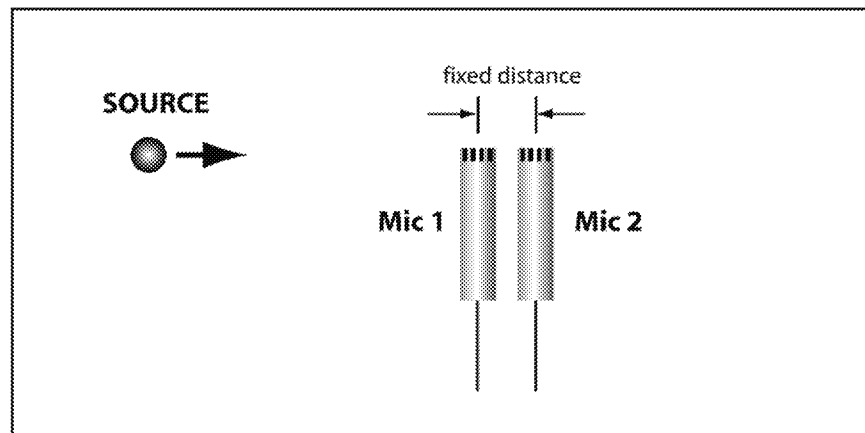

**Figure 7-2.** Side-by-Side Microphone Probe

To determine the total sound power of a source in watts, the sound intensity ( $I_k$ ) must be first measured perpendicular to the unit area ( $A_k$ ) (Figure 7-3). The power for that unit area ( $W_k$ ) is then the product of  $I_k$  and  $A_k$ . Therefore, the total power ( $W_{total}$ ) is calculated as follows:

$$W_{total} = \sum_1^K (A_k \times I_k) \tag{7-6}$$

The result in units of decibel can be calculated from Equation 7-2, or shown in B by dividing the decibel result by 10.

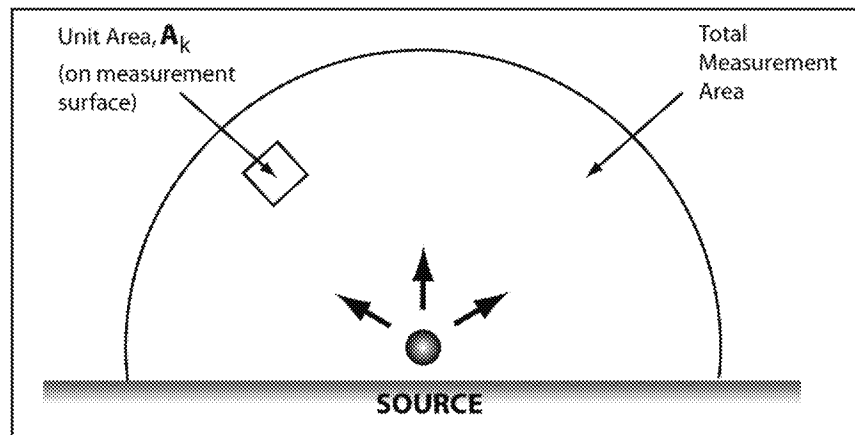

Figure 7-3. Sound Power Measurement Area

## 7.3 Tire/Pavement Noise

In Section 2, noise is discussed in terms of source, path, and receiver. All three components must be present before noise impacts can occur. Strategies involving quieting the source, disrupting the path, or insulating the receiver may conceptually be used to achieve noise abatement. Using a common analogy of a loud stereo set in a room, there are three options open to lowering the sound to a listener in an adjacent room. The first is lowering the volume at the stereo, quieting the source. The second option is to close the door between the two rooms, disrupting the path. As a third option, the listener can wear earplugs, insulating the receiver.

Although quieting the source would conceptually be the simplest and most effective method of noise abatement, Caltrans has so far dealt with noise abatement by disrupting the path by constructing noise barriers between the highway source and resident receivers. This approach is used because Caltrans has limited options at quieting the highway noise source. For instance, Caltrans has no control over quieting vehicles. This has been the responsibility of the U.S. Environmental Protection Agency, which over the years, through regulatory and legislative action, has mandated stricter new vehicle noise standards, especially for trucks. The only control Caltrans has at the source is highway design. Highway alignments could be selected away from sensitive receivers, and new highways could be depressed. Unfortunately, many factors other than noise dictate highway design. In addition, new development often occurs along existing highways, further limiting noise abatement options.

One detail of highway design that affects noise at the source is the type and texture of pavement used. There are two major types of pavement:

flexible asphalt concrete (AC) which is black in color and rigid PCC which is white in color. Historically, new AC generally tends to be quieter than new PCC, but aggregate size, surface texture, and age/condition can cause wide variations in tire pavement noise levels. The differences in noise reducing characteristics between AC and PCC are narrowing as new construction techniques are being developed. It has been well known for at least a decade that OGAC produces less noise from tire/pavement interaction than DGAC. It is also known that longitudinal (parallel to direction of travel) texturing, tining, or grooving in PCC is much less noisy than transverse (perpendicular to direction of travel) texturing, tining, or grooving. What is least understood is the longevity of the lower noise benefits associated with “quieter” pavement. There are many regional variables that affect pavement performance, such as road base condition, environment, traffic loads, mix design, and quality of construction material and methods. In general as pavements age and wear, the acoustic characteristics change and tire/pavement noise becomes louder.

Caltrans has gathered increasing evidence that OGAC retains its noise reduction benefits throughout the years in typical applications at lower elevations on snow-free highways. The longest-running quiet pavement noise study to date, being conducted on I-80 near Davis, California, demonstrates that after over 13 years of operation, OGAC continues to yield 4- to 5-dBA lower noise levels than the previous DGAC pavement. Other studies have shown the same trend. The pavement noise results are based on actual traffic streams, wayside noise measurements carefully controlled for the effects of meteorology, and supplemental OBSI measurements.

Studies using innovative approaches such as sound-intensity measurements of tire/pavement interactions have been employed to study the relative noise benefits of various pavement mixes and textures. In all cases, the sound-intensity measurements are augmented and correlated with wayside noise measurements. This is important because vehicle noise consists of four primary subsources: mechanical noise, exhaust noise (stack exhaust on heavy trucks), tire/pavement noise, and aerodynamic noise (at high speeds). The stricter EPA standards initiated in the 1970s have lowered mechanical and exhaust noise subsources. At highway speeds, tire/pavement noise affects total vehicle noise to a greater extent than all the other vehicle noise subsources combined. Tire/pavement noise on a passenger car operating at a steady freeway speed may account for as much as 75% to 90% of the vehicle noise energy, but these percentages may not be the same on louder, more acoustically complex heavy trucks. It is possible to perceptively lower overall traffic noise levels by careful pavement selection and design. Future Caltrans-sponsored research will include the relative contribution of subsources of vehicles to help confirm



the validity of the importance of tire/pavement noise through the use of complex microphone arrays and multi-channel signal processors.

FHWA policy does not allow quieter pavement to be considered as a noise abatement measure. Caltrans practice of calibrating noise prediction models allows for optional calibration adjustments for various pavement types (California Department of Transportation 2003). This practice does not mean that quieter pavement is to be used as a noise abatement measure. Rather, the process is used to account for an otherwise unexplained portion of differences between measured and predicted noise results. Without the adjustment for pavement, this difference would have been added anyway, without explaining the cause.

The following studies and reports provide useful and relevant information related to tire/pavement noise.

*Determining End Limits of Quieter Pavement Projects* (Rymer and Donavan 2011).

*Standard Method of Test for Measurement of Tire/Pavement Noise Using the On-Board Sound Intensity (OBSI) Method* (American Association of State Highway and Transportation Officials 2012)

*I-80 Davis OGAC Pavement Noise Study* (Illingworth & Rodkin 2011a)

*Eight Year Evaluation of the Noise Performance of the Caltrans Asphalt Research Pavements on LA 138* (Illingworth & Rodkin 2011b)

*Initial and Long-Term Evaluation of the Tire-Pavement Noise Produced by Various Portland Cement Concrete Surface Textures Measurements on the State Route KN 58 Mojave Bypass 2003 to 2010* (Illingworth & Rodkin 2011c)

*Comparative Measurements of Tire/Pavement Noise in Europe and the United States Noise Intensity Testing in Europe (NITE) Study* (Illingworth & Rodkin 2006)

*Caltrans Thin Lift Study: Effects of Asphalt Pavements on Wayside Noise* (Rochat et al. 2010)

Caltrans Memorandum—Quieter Pavement Bulletin (Shatnawi 2009)

NCHRP Report 635 Acoustic Beamforming: Mapping Sources of Truck Noise (National Cooperative Highway Research Program 2009)

NCHRP Project 1-44: Measuring Tire-Pavement Noise at the Source (National Cooperative Highway Research Program 2011a)

NCHRP Project 1-44 (1) Measuring Tire-Pavement Noise at the Source: Precision and Bias Statement (National Cooperative Highway Research Program 2011b)

*The Little Book of Quieter Pavement* (Federal Highway Administration 2007)

Rumble strips and expansion joints can be the source of impulse noise when vehicle tires strike the strips or joints. Locations of rumble strips or expansion joints relative to noise sensitive receptors should be considered to minimize community noise impacts. Alternative rumble strip and expansion joint designs that reduce noise are currently being explored by Caltrans.

## 7.4 Insulating Facilities from Highway Noise

Revisions to 23 CFR 772 that occurred in 2011 eliminated the interior noise abatement criterion for residential uses and eliminated noise insulation of private residences as a fundable form of noise abatement. 23 CFR 772 does however include an interior noise abatement criterion for Activity Category D land use facilities (auditoriums, day care centers, hospitals, libraries, medical facilities, places of worship, public meeting rooms, public or nonprofit institutional structures, radio studios, recording studios, schools, and television studios.) Noise insulation of Activity Category D land use facilities is listed in 23 CFR 772 as a fundable form of noise abatement.

If a situation arises where interior noise at Activity Category D land use facilities must be evaluated as part of a noise study report, the normal procedure is to determine exterior noise levels using standard modeling methods and then to apply building noise reduction factors recommended by FHWA based on the building construction type and window condition. Table 7-1 summarizes building noise reduction factors recommended by FHWA (Federal Highway Administration 2011).

**Table 7-1. FHWA Building Noise Reduction Factors**

Building Type	Window Condition	Noise Reduction Due to Exterior of Building
All	Open	10 dB
Light Frame	Ordinary Sash (closed)	20 dB
	Storm Windows	25 dB
Masonry	Single Glazed	25 dB
	Double Glazed	30 dB
The windows shall be considered open unless there is firm knowledge that the windows are in fact kept closed almost every day of the year.		

Source: Federal Highway Administration 2011.

If interior noise impacts are identified the first course of action is to consider the use of an exterior barrier to reduce noise. If an exterior barrier is not feasible or does not provide sufficient noise reduction, insulation of the facility can be considered. This would require a detailed evaluation of existing building noise reduction and potential methods for improving the noise reduction. The 2009 version of TeNS provides detailed methods for measuring existing building noise reduction which are consistent with ASTM E966-02, “Standard Guide for Field Measurements of Airborne Sound Insulation of Building Facades and Façade Elements.”

## 7.5 Construction Noise Analysis, Monitoring, and Abatement

Construction noise is usually a concern only in exceptional cases, such as when pile driving and crack-and-seat pavement rehabilitation operations are planned. Ground vibration generated by pile driving and crack-and-seat operation also increase concern by the public. Caltrans Standard Specifications Sections 14-8 and the Caltrans Standard Special Provisions Section 5-1 discuss construction noise levels. Caltrans Standard Specifications are applied to all construction projects. The Standard

Special Provisions provide a menu of special provisions that can be selectively applied to a project based on the specific needs of the project.

Section 14-8 of the Caltrans standard specifications addresses noise and states:

Do not exceed 86 dBA  $L_{max}$  at 50 feet from the job site activities from 9 p.m. to 6 a.m.

Equip an internal combustion engine with the manufacturer-recommended muffler. Do not operate an internal combustion engine on the job site without the appropriate muffler.

Section 5-1, *Noise Control*, of the Standard Special Provisions states the following.

**General**

This section applies to equipment on the project or associated with the project, including trucks, transit mixers, stationary equipment, and transient equipment. Do not exceed 86 dBA  $L_{max}$  at 50 feet from the job site activities from \_\_\_\_ p.m. to \_\_\_\_ a.m. except you may perform the following activities during the hours and for the days shown in the following table:

Noise Restriction Exceptions				
Activity	Hours		Days	
	From	To	From	Through

Do not operate construction equipment or run the equipment engines from 7:00 p.m. to 7:00 a.m. or on Sundays except you may operate equipment within the project limits during these hours to:

1. Service traffic control facilities.
2. Service construction equipment.

**Noise Monitoring**

Provide one Type 1 sound level meter and one acoustic calibrator to be used by the Department until contract acceptance. Provide training by a person trained in noise monitoring to one Department employee designated by the Engineer. The sound level meter must be calibrated and certified by the manufacturer or other independent acoustical laboratory before delivery to the Department. Provide annual recalibration by the manufacturer or other independent acoustical laboratory. The sound level meter must be capable of taking measurements using the A-weighting network and the slow response settings. The measurement microphone must be fitted with a windscreen. The Department returns the equipment to you at contract acceptance. Use if a sound meter is required. The contract lump sum

price paid for noise monitoring includes full compensation for furnishing all labor, materials, tools, equipment and incidentals and for doing all work involved in noise monitoring.

As a state agency, Caltrans is not required to comply with local noise ordinances. However, as a matter of practice, it is Caltrans' intent to comply with 23 CFR 771.105 which states that it is FHWA policy that:

[t]o the fullest extent possible all environmental investigations, reviews, and consultation be coordinated as a single process, and compliance with all applicable environmental requirements shall be reflected in the environmental documentation.

If construction noise on any highway project is anticipated to be a substantial concern, further analysis is recommended. The following items are to be examined.

- Land uses or activities that may be affected by construction noise.
- Level, timing (scheduling), and duration of construction.
- Measures to reduce adverse construction noise impacts on the community that could be included in the project's plans and specifications.

Caltrans does not routinely analyze construction noise during the project development phase. However, as is discussed in Section 6.3.2, construction noise impacts and likely abatement measures (if necessary) should be discussed briefly in the noise study report for all projects. Generally, Caltrans will only consider construction noise and its abatement in greater detail during the project impact analysis if the project is large, is controversial, or has a prolonged construction phase with extensive pile driving or other loud operations. Construction noise impacts on wildlife may also need to be considered in some special situations. An example would be where pile driving will occur near nesting birds that are on the endangered species list. The effects of noise on wildlife are discussed in more detail in Section 7.8.

Caltrans construction or environmental personnel are sometimes asked to monitor construction noise levels during the construction phase to ensure the contractor's compliance with the Caltrans Standard Specifications, project-specific Special Provisions, or other construction noise limits that may be imposed on the project. The monitoring is usually performed in response to complaints from adjacent residents, but there may also be situations where the contractor must demonstrate compliance with a specific limit on noise.

In January 2006, the FHWA published the FHWA Roadway Construction Noise Model Users guide, which provides guidance on how to use the

FHWA Windows-based construction noise model. It provides useful information on construction noise analysis, equipment noise source levels, and impact criteria.

In addition to noise, construction activities can potentially generate earthborne vibrations that may disturb, damage, or interfere with activities at vibration-sensitive receivers. Section 7.6 briefly discusses earthborne vibrations.

## **7.5.1 Consideration of Construction Noise during Project Development Phase**

If the project is large, is controversial, or has a prolonged construction phase with extensive pile driving or other loud operations, construction noise should be analyzed during the project development phase, along with routine noise analyses, and the analysis should be included in the environmental documentation. Details of construction operations are frequently lacking or minimal in this phase. Therefore, the analysis will usually be qualitative rather than quantitative, and addressed in the environmental document only in general terms, with references to the Standard Specification, Standard Special Provisions, and other appropriate directives. A qualitative discussion may include information on the following topics.

- Residences or land use activities to be impacted most by construction noise.
- Principal types of equipment to be used.
- Noise characteristics (impact noise, continuous noise, etc.) and range of noise levels of equipment used at reference distances.
- Duration of construction and the loudest operations.
- Appropriate specifications, special provisions, and regulations by which the contractor must abide.
- Noise monitoring for compliance during construction.
- Abatement strategies that can potentially be provided, such as one or more of the following.
  - Temporary walls, earth berms, or noise curtains.
  - Alternative, less noisy construction methods.
  - Restricted hours of operation.
  - Planning and routing haul roads away from residences.

- Building soundwalls required for traffic noise abatement for the project first.

If some details about the types and numbers of construction equipment, types of operations, duration, and scheduling are available during the project development phase, a quantitative analysis may be performed. A quantitative analysis may include all of the factors for the qualitative analysis and the following.

- Calculating expected noise levels at the affected receivers or at a standard distance (usually 50 feet) as dictated by criteria.
- Comparisons of calculated noise levels to specifications, special provisions, and other pertinent criteria.

Caltrans construction noise criteria are typically expressed using the  $L_{\max}$  descriptor at a reference distance. As stated above, an  $L_{\max}$  of 86 dBA at 50 feet is commonly used by Caltrans as a maximum construction noise limit. Equipment and operations are usually at or less than that level, except for blasting, pile drivers (impact or vibratory), hoe rams, pavement breakers for crack-and-seat operations, and other impact equipment. Table 7-2 summarizes typical construction noise levels identified in the FHWA Roadway Construction Noise Model User's Guide (Federal Highway Administration 2006). These noise levels come directly from data developed during the construction of the Central Artery Tunnel Project in Boston completed December 2007.

**Table 7-2. Typical Construction Equipment Noise**

Equipment Description	$L_{\max}$ Noise Limit at 50 feet, dB, Slow	Usage Factor	Impact Device?
All other equipment more than 5 horsepower	85	50	No
Auger drill rig	85	20	No
Backhoe	80	40	No
Bar bender	80	20	No
Blasting	94	N/A	Yes
Boring jack power unit	80	50	No
Chain saw	85	20	No
Clam shovel	93	20	Yes
Compactor (ground)	80	20	No
Compressor (air)	80	40	No
Concrete batch plant	83	15	No
Concrete mixer truck	85	40	No
Concrete pump truck	82	20	No
Concrete saw	90	20	No

Equipment Description	$L_{\max}$ Noise Limit at 50 feet, dB, Slow	Usage Factor	Impact Device?
Crane (mobile or stationary)	85	16	No
Dozer	85	40	No
Dump truck	84	40	No
Excavator	85	40	No
Flat bed truck	84	40	No
Front end loader	80	40	No
Generator (25 kilovolt-amperes [kVA] or less)	70	50	No
Generator (more than 25 kVA)	82	50	No
Gradall	85	40	No
Grader	85	40	No
Horizontal boring hydraulic jack	80	25	No
Hydra break ram	90	10	Yes
Impact pile driver (diesel or drop)	95	20	Yes
Jackhammer	85	20	Yes
Mounted impact hammer (hoe ram)	90	20	Yes
Paver	85	50	No
Pickup truck	55	40	No
Pneumatic tools	85	50	No
Pumps	77	50	No
Rock drill	85	20	No
Scraper	85	40	No
Slurry plant	78	100	No
Slurry trenching machine	82	50	No
Soil mix drill rig	80	50	No
Tractor	84	40	No
Vacuum street sweeper	80	10	No
Vibratory concrete mixer	80	20	No
Vibratory pile driver	95	20	No
Welder/Torch	73	40	No

Source: Federal Highway Administration 2006.

Table 7-2 also provides a typical usage factor for each equipment type. The usage factor is an estimate of the fraction of time each piece of equipment operates at full power. The usage factor can be used to estimate  $L_{\text{eq}}$  from the  $L_{\max}$  values listed in Table 7-2 in those cases where the impact criteria is expressed in terms of  $L_{\text{eq}}$ . Equation 7-10 can be used to estimate  $L_{\text{eq}}$  from  $L_{\max}$ . It also includes a term for estimating noise at distances other than 50 feet.



$$L_{eq}(h), \text{ dBA} = L_{max} \text{ at 50 feet} - 20\log(D / 50) + 10\log(UF) \quad (7-7)$$

Where:

$L_{max}$  at 50 feet can be looked up in Table 7-2 or similar table

D = distance of interest

UF = usage factor or fraction of time period of interest equipment is in use

If more than one piece of equipment is in operation in the same location, Equation 7-7 can be used for each piece of equipment and the results can be summed to give a combined noise level at the location of interest. Typically, only noise levels from the two or three loudest pieces of equipment are summed. The FHWA Roadway Construction Noise Model automates most of this process.

## 7.5.2 Noise Monitoring during Construction

Construction noise monitoring may be part of a program called for in the environmental document, in regulatory permits, or in response to noise complaints. Noise monitoring requirements may be in response to effects on both humans and wildlife. Refer to Section 7.8 for more discussion on the effects of construction noise on wildlife. In most cases, the noise measurements are used to ensure compliance with the appropriate criteria specified in construction contract specifications or other applicable regulations. In the case of complaints, measurements may be conducted to identify the source of the complaints and to develop solutions for reducing the noise. As discussed above, Caltrans is not required to comply with local noise ordinances. However, as a matter of practice, it is Caltrans intent to comply with all applicable environmental requirements per 23 CFR 771.105.

If construction noise monitoring is necessary, the districts' environmental units or trained construction personnel will usually perform the measurements. In some cases, the contractor or subcontractor may perform noise monitoring as part of the construction contract.

The manner in which construction noise measurements are taken depends on the applicable criteria. If the criterion calls for a certain  $L_{max}$  at a reference distance, the sound level meter must be placed at the requested distance from stationary equipment and the noise measured in the  $L_{max}$  mode during full operation of the equipment. Ideally, the noise level should be measured from four different directions, approximately 90° from each other (Figure 7-4). This may not be possible, however, and perhaps only two or three directions can be measured. A sufficient time period in each of the microphone positions should be allowed to permit the

$L_{max}$  to occur. Sound level meters usually have an  $L_{max}$ -hold button. In this mode, the recorded  $L_{max}$  only changes when a higher noise level than the previous maximum is recorded. If the noise is relatively constant and the  $L_{max}$ -hold does not change for 30 seconds, the measurement is completed. If the noise is not constant, such as with pile driving, a longer time period of at least 2 minutes is recommended.

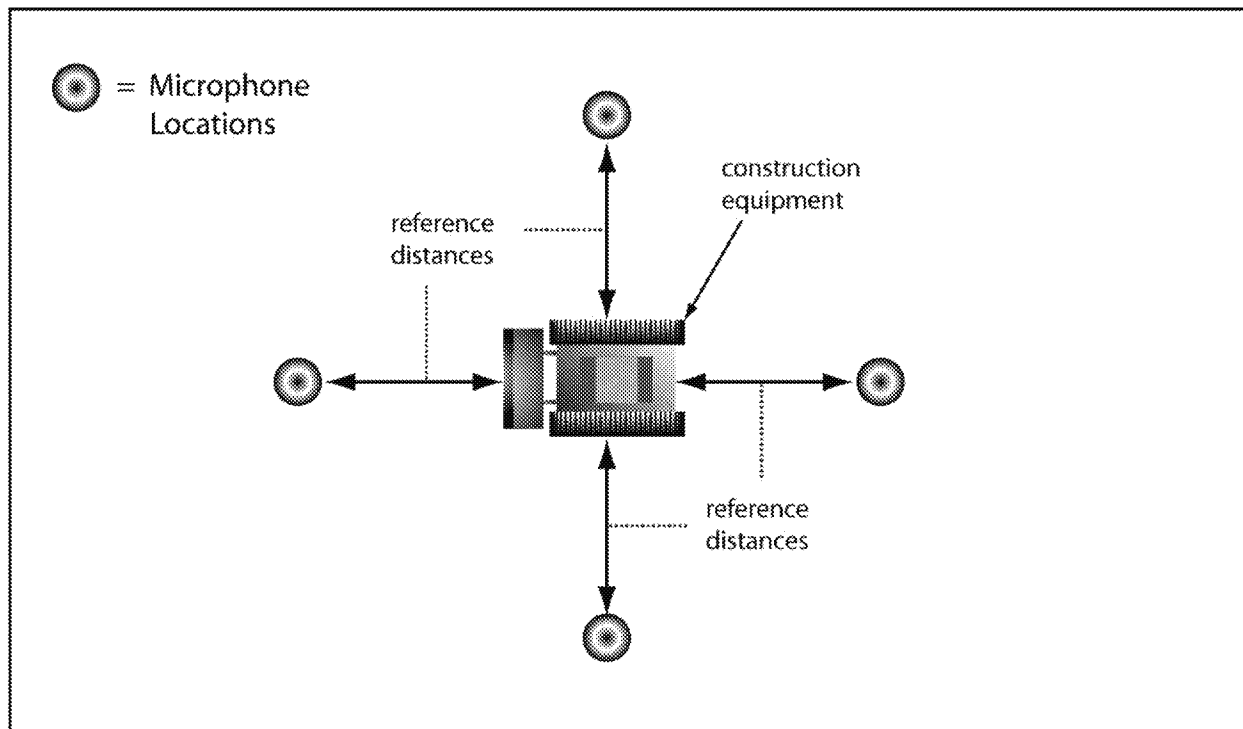
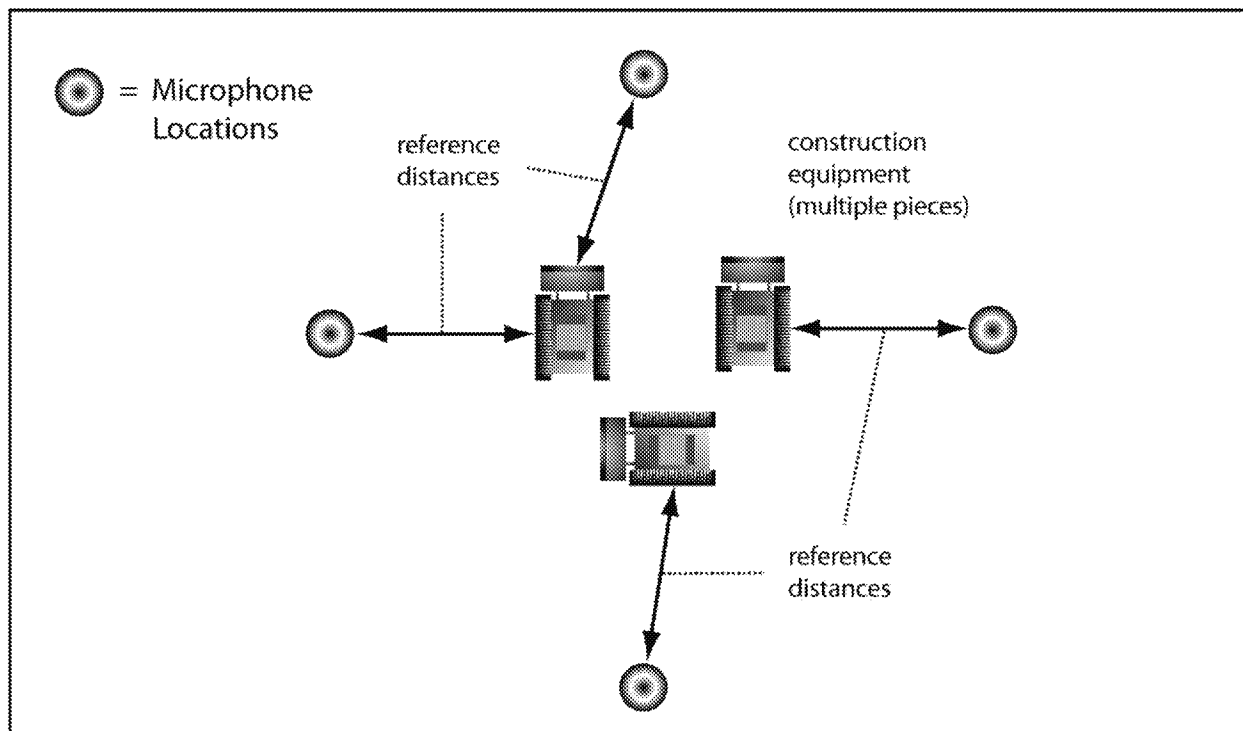

Figure 7-4. Measuring One Piece of Equipment

If more than one piece of stationary construction equipment is involved in the same operation, the reference distance should be measured from the nearest piece of equipment, preferably from various directions (Figure 7-5).



**Figure 7-5.** Measuring Multiple Pieces of Equipment Operating in Same Area

For mobile equipment, the reference distance is the closest distance at the point of passby. The equipment should be measured from two directions—equipment moving from left to right and from right to left.

If the response time setting of the meter is not specified in the criteria, the slow setting should be used for equipment producing continuous noise. For impact noise, such as pile driving, the response setting should be switched to impulse. In all cases, a minimum of three measurements should be taken at each microphone position. The highest  $L_{max}$  should be used for comparison with applicable standards or criteria.

In the less frequent cases where a construction noise criterion may call for a certain noise level at the project right-of-way line or a residence, the microphone locations must coincide with the locations called for in the criterion. In the event a criterion calls for a descriptor different from  $L_{max}$ , such as  $L_{eq}$ , the proper descriptor must be measured by the sound level meter. All previously mentioned provisions are applicable. Section 3 should be consulted for general noise measurement provisions.

Additional information on construction noise measurements can be found in “Measurement of Highway-Related Noise,” Report FHWA-PD-96-046, May 1996, available through the National Technical Information Service

in Springfield, Virginia, and in the FHWA Construction Noise Handbook which is available:

[http://www.fhwa.dot.gov/environment/noise/construction\\_noise/handbook](http://www.fhwa.dot.gov/environment/noise/construction_noise/handbook)

## **7.5.3 Construction Noise Abatement**

In the event that construction noise exceeds or is expected to exceed applicable standards and criteria, the following options are open to abate the noise at the source, in the path, and at the receiver.

### **7.5.3.1 Abatement at Source**

Noise control at the source is the most sensible approach because it does not limit abatement for a single source-receiver pair, but instead lowers construction noise at all receivers. Caltrans Standard Specifications require all construction equipment to have adequate mufflers and be well maintained. If these specifications are not enough to reduce noise levels to less than the standards and criteria, other options can be used, including one or more of the following.

- Reroute haul routes away from residences.
- Require modern equipment.
- Plan noisiest operations for times of day when people are less sensitive to noise.
- Plan operations to minimize the use of backup warning devices.
- Set backup warning devices to lowest level without jeopardizing safety.
- Operate equipment at minimum power.
- Use quieter alternate methods or equipment.

### **7.5.3.2 Abatement in Path**

There are several options open to abate construction noise in the source-to-receiver noise path. These usually include temporary enclosures around stationary equipment, temporary barriers, and noise curtains. If permanent noise barriers are part of the project, their construction should be scheduled first. Other strategies include effective use of temporary earth mounds as barriers, creating buffer zones between equipment and residences, or making use of existing structures as barriers.

### **7.5.3.3 Abatement at Receiver**

Abatement at the residence is usually done as a last resort. Strategies include window treatment or other insulation techniques. This is usually only cost-effective if relatively few residences are involved. Another strategy is temporary relocation of residents.

### **7.5.3.4 Community Awareness**

Community awareness may be the most effective approach to reduce complaints of construction noise. Residents' tolerance toward construction noise is greatly increased if they are informed that the noise is temporary, that they have a telephone number to call for more information and to report specific noise concern, and that every effort will be made to address those concerns. Door-to-door personal contacts are the most effective, but this may be time-consuming. Other ways to relate the information are hotlines, project websites, automated phone calls, frequent community meetings, letters to the impacted residences, and local news coverage.

If construction noise is anticipated to be a major issue, the community should have an opportunity to provide considerable input early in the project development stage. It is essential that communication channels between the Caltrans resident engineer and the community stay open during the construction phase as well. A real time monitoring and reporting system with posting of measured noise levels on a website can be an effective way to keep the public informed on the project noise conditions associated with large, long-term projects. Responsibilities for addressing noise complaints should be included in the construction contract documents.

## **7.6 Earthborne Vibration**

Caltrans has been involved with vibration studies since 1958. Until 1992, the Caltrans Transportation Laboratory in Sacramento conducted all vibration studies. Since then, most vibration studies have been contracted out. However, the Caltrans Division of Environmental Analysis does perform some vibration monitoring to investigate complaints.

Earthborne vibrations generated by construction activities or by traffic once a transportation facility is in operation can under certain circumstances be a serious concern. This section emphasizes the awareness and early recognition of potential vibration issues. When vibration-sensitive receptors or activities are located near a proposed new

alignment or near an existing facility scheduled for heavy reconstruction, potential vibration impacts should be addressed during the project development phase with assistance of the Caltrans Division of Environmental Analysis. Caltrans' *Transportation- and Construction-Induced Vibration Guidance Manual* (2004) provides a wealth of information on vibration, including summaries of Caltrans experiences, and should be consulted.

During construction, pile driving, pavement breaking for crack-and-seat operations, demolition of old structures, and blasting are among the worst vibration offenders. Concerns may include annoyance, interference with activities, and structural damage. Therefore, construction activities involving generation of high-level vibrations must be carefully planned.

Although construction activities potentially generate the highest vibration levels and most damage, they are temporary in nature. Long-term effects of vibration may be caused by the transportation facility after it is completed. Normally, highway traffic does not generate high enough levels to cause damage to residences or other structures, even at very close distances. However, vibrations caused by heavy trucks can interfere with vibration-sensitive activities or equipment. Laboratories using sensitive electronic equipment, laser surgery, or close-tolerance machining are a few examples of operations that can be affected by nearby highway traffic.

In addition trains can produce some of the highest vibrations on a transportation facility. Caltrans has needed to consider cases involving train vibrations where a new highway or light-rail facility necessitated realignment of railroad tracks closer to residences or sensitive operations.

Potential vibration issues should be recognized as early as possible, and strategies to address the concerns should be coordinated with the Caltrans Division of Environmental Analysis. Potentially impacted vibration-sensitive receptors should be considered early in the design development process so that effective mitigation design strategies can be identified.

## **7.7 Occupational Hearing Loss and OSHA Noise Standards**

This section does not pertain to environmental noise standards or NAC. Occupational hearing loss is a concern in certain occupations where workers are exposed to high noise levels. These occupations could be relevant to Caltrans operations, such as construction, maintenance, and materials laboratories. OSHA has set standards for permissible noise exposures. When the limits of these permissible exposures are approached,

OSHA requires the employer “to administer a continuing, effective hearing conservation program” to prevent hearing loss. When the maximum allowable noise exposure is exceeded, the employer must take certain steps to control the noise. OSHA occupational noise exposure standards are addressed by 29 CFR 1910.95 and should be consulted if excessive noise exposure is suspected. For general reference, the most relevant information in 29 CFR 1910.95 is summarized below.

### 7.7.1 Noise-Induced Hearing Loss

Occupational noise-induced hearing loss develops slowly over a period of time when exposed to high continuous or intermittent noise levels. This should not be confused with traumatic hearing loss, which is caused by a single transient high-level noise event, such as a gunshot or explosion. The most important aspects of occupational noise-induced hearing loss are listed below.

- It is always sensory-neural (affects the hair cells in the inner ear).
- It typically affects both ears equally.
- The first sign of hearing loss is a *notching*, or reduced hearing sensitivity at 3,000, 4,000, or 6,000 Hz, with normal sensitivity in higher or lower frequencies. This is in contrast to age-related hearing loss, which also begins at 3,000 to 6,000 Hz but continues into higher frequencies.
- Noise-induced hearing loss due to chronic noise exposure is greatest during the first 10 years or so of exposure and slows down afterward. Age-related hearing loss, however, accelerates over time.
- Noise-exposed ears are not more sensitive to future noise exposure and do not progress beyond the added normal age-related hearing loss once the noise exposure is discontinued.

### 7.7.2 OSHA Noise Standards

Occasionally, the exposure of Caltrans personnel or contractors to noise is a concern. 29 CFR 1910.95(a) requires the employer to protect the employee against the effects of noise exposure when the permissible noise exposures in Table 7-3 are exceeded. The noise levels must be measured on the A-scale with the sound level meter at slow response.

29 CFR 1910.95(b)(1) requires that when the permissible noise exposure levels are exceeded, “feasible administrative or engineering controls shall be utilized. If such controls fail to reduce sound levels within the levels of

Table [7-3], personal protective equipment shall be provided and used to reduce sound levels within the levels of the table.”

29 CFR 1910.95(b)(2) considers variations in noise level involving maxima at intervals of 1 second or less to be continuous.

**Table 7-3. Table G-16 Permissible Noise Exposure**

Duration per Day (Hours)	Sound Level (dBA, Slow Response)
8	90
6	92
4	95
3	97
2	100
1.5	102
1	105
0.5	110
0.25 or less	115

Notes: When the daily noise exposure is composed of two or more periods of noise exposure of different levels, their combined effect should be considered, rather than the individual effect of each. If the sum of the following fractions  $[C(1) / T(1)] + [C(2) / T(2)] + \dots + [C(n) / T(n)]$  exceeds 1, the mixed exposure should be considered to exceed the limit value. C(1), C(2), etc. indicate the times of exposure at a specific noise level. T(1), T(2), etc. indicate the times permissible for that specific exposure. Exposure to impulsive or impact noise should not exceed 140 dB peak (as opposed to rms) sound pressure level.

Two simple examples of the calculation shown in the footnote of the above table are provided below.

- C(1) = 3 hours at 95 dBA and C(2) = 5 hours at 90 dBA. The corresponding T(1) and T(2) values from the permissible noise exposure table are T(1) = 4 hours and T(2) = 8 hours. Using the calculation in the footnote, the exposure is:

$$3/4 + 5/8 = 0.75 + 0.625 = \mathbf{1.375 (>1)}.$$

The maximum allowable exposure has been exceeded.

- C(1) = 1 hour at 100 dBA and C(2) = 3 hours at 90 dBA. The corresponding T(1) and T(2) values from the permissible noise exposure table are T(1) = 2 hours and T(2) = 8 hours. Using the calculation in the footnote, the exposure is:

$$1/2 + 3/8 = 0.50 + 0.375 = \mathbf{0.875 (<1)}.$$

The maximum allowable exposure has not been exceeded.



The fractions may also be expressed as percentages, with 100% the maximum allowable exposure level. The first example would result in 137.5% and the second in 87.5%.

29 CFR 1910.95(c)(1–2) requires the employer to “administer a continuing, effective hearing conservation program... whenever employee noise exposures equal or exceed an 8-hour time-weighted average sound level... of 85 decibels, measured on the A-scale (slow response). Or equivalently, a dose of fifty percent.” The 85-dBA noise level or dose of 50% is also referred to as the action level. The hearing conservation program is fully described in 29 CFR 1910.95(c–o).

## **7.8 Effects of Transportation and Construction Noise on Marine Life and Wildlife (Bioacoustics)**

The effects of highway and construction noise on marine life and wildlife is generally referred to as bioacoustics. Concerns regarding these effects generally arise in response to requirements of the federal Endangered Species Act, National Marine Fisheries Service, U.S. Fish and Wildlife Service, California Department of Fish and Wildlife, and other resource agencies that have jurisdiction in the project area.

Caltrans biologists routinely address environmental issues related to all of the effects of transportation and construction on animals. Noise is only one of the issues, but it can be an important factor in the overall impact assessment. Underwater noise from pile driving can affect some fish within close range. In the San Diego area, Caltrans has built earth berms and soundwalls to protect nesting areas for Least Bell’s Vireo, an endangered bird species. The task of addressing noise impacts on marine and terrestrial wildlife rests primarily with the biologists. However, noise analysts provide a supporting role to the biologists in providing technical noise expertise. Accordingly, it is critical that biologists coordinate directly with the project noise analyst when evaluating noise impacts on wildlife.

Addressing the effects of noise on marine and terrestrial animal species provides an exceptionally difficult challenge and requires specialized expertise. With marine life, the acoustical environment is vastly different than on land. In both marine and terrestrial environments, there is a great variety of animal species, each with different tolerances to noise. The nature of the adverse effects on the different species can also differ. On land, some birds may be flushed from their nesting areas, which may

interfere with reproduction. Songbirds, which depend on their songs to find a mate, may be unable to communicate with each other in a noisy environment, therefore missing the opportunity to reproduce. Other animals may be temporarily or permanently driven from their habitat. The hearing frequency response to noise is also different in each species. For example the hearing range for humans is 20 to 20kHz whereas the hearing range for bats is 10 Hz to 200 kHz and the range for birds is 1KHz to 5 KHz. Accordingly, the use of the human response A-scale when evaluating noise impacts on other species may not be appropriate in some cases.

The Caltrans' document *Technical Guidance for Assessment and Mitigation of the Hydroacoustic Effects of Pile Driving on Fish* (Guidance Manual) provides detailed guidance on the process for evaluating underwater noise impacts on fish from pile driving (2009). This document is available:

<[http://www.dot.ca.gov/hq/env/bio/fisheries\\_bioacoustics.htm](http://www.dot.ca.gov/hq/env/bio/fisheries_bioacoustics.htm)>.

National Cooperative Highway Research Program Research Results Digest 363- Hydroacoustic Impacts on Fish from Pile Installation (National Cooperative Highway Research Program 2011c) provides additional on pile driving noise impacts on fish. This document is available:

<[http://onlinepubs.trb.org/onlinepubs/nchrp/nchrp\\_rrd\\_363.pdf](http://onlinepubs.trb.org/onlinepubs/nchrp/nchrp_rrd_363.pdf)>.

Specific guidance on how to address airborne noise effects on terrestrial wildlife has not yet been developed by Caltrans. Caltrans has however commissioned a report entitled *The Effects of Highway Noise on Birds* (Dooling and Popper 2007) which provides background on the effects of noise on birds and provides recommended criteria for impact assessment. This document is available:

<[http://www.dot.ca.gov/hq/env/bio/avian\\_bioacoustics.htm](http://www.dot.ca.gov/hq/env/bio/avian_bioacoustics.htm)>

Another useful resource is the FHWA document *Synthesis of Noise Effects on Wildlife Populations* (Federal Highway Administration 2004).

## Section 8

# Glossary

The terms and definitions in this glossary are either used in this TeNS or are commonly found in environmental noise literature. To make this glossary more useful to the highway traffic noise analyst, these definitions are generally oriented toward highway traffic noise and abatement, not general acoustics.

**Absorption:** The attenuation of sound caused by conversion of sound energy into other forms of energy, usually heat, within a medium. Absorption is a property of the medium. In noise barrier material, absorption can be considered the complement of reflection. A perfectly absorptive material does not reflect any sound energy, and a non-absorptive (i.e., reflective) material reflects almost all sound energy. In either case, a small portion of sound energy is transmitted through the barrier and continues in roughly the same direction as the incident noise propagation. In typical highway traffic noise barriers, the sound energy passing through is less than 1% of the incident noise energy. See also “Transmission Loss.”

**Absorption Coefficient:** A term that approximately equals the ratio of sound energy absorbed by a material to the energy incident on the material. Absorption coefficients range from 0 (no absorption) to 1 (perfect absorption). In highway noise barriers, material with an absorption coefficient of 0 will reflect back almost all incident noise energy, and material with a coefficient of 1 will not reflect back any sound energy. The absorption coefficient depends on material, sound frequency, and angle of incidence.

**Absorptive Grounds:** Types of ground, such as normal earth and most grounds with vegetation, that are absorptive to sound energy and that reverse the phase of reflected energy at grazing angles of incidence. See also “Soft Sites” and “Ground Effects.”

**Acoustics:** The broad field of science that deals with the production, propagation, reception, effects, and control of sound, both audible and inaudible to the human ear, and occurring in all media.

**Airborne Sound:** Sound that reaches the point of interest primarily by propagation through the air.

**Ambient Noise:** All-encompassing noise at a given place and time. This is usually a composite of sounds from all sources near and far, including any specific sources of interest.

**Amplitude:** The strength or magnitude of the pressure of a sound wave.

**Anechoic Chamber:** A room that has boundaries designed to absorb nearly all of the sound incident on them, producing a test room that is essentially free from reflected sound, and simulates free field conditions for the limited space defined by the room's boundaries.

**Angle of Diffraction:** The angle through which sound energy is diffracted as it passes over the top of a noise barrier and proceeds toward the receiver. Receivers deeper into the shadow zone have larger angles of diffraction and therefore higher barrier attenuation. See also "Diffraction" and "Shadow Zone."

**Angle of Incidence:** The angle formed by the radial line of sound waves striking a surface at a specific location and the plane of that surface. See also "Angle of Reflection."

**Angle of Reflection:** The angle formed by the radial line of sound waves reflecting off a surface at a specific location and the plane of that surface. See also "Angle of Incidence."

**Atmospheric Effects:** Sound absorption by air molecules and water vapor, sound refraction caused by temperature and near-ground wind gradients, and air turbulence are collectively called atmospheric effects. Although atmospheric effects are mostly responsible for substantial noise fluctuations at distant receivers, they also can have a significant effect at distances within 330 feet.

**Audible Spectrum:** The frequency range normally associated with human hearing, usually considered between 16 and 20,000 Hz. For noise control purposes, the audible spectrum of interest usually lies between 20 and 10,000 Hz.

**Audiogram:** A graph showing hearing loss as a function of frequency.

**Audiometer:** An instrument for measuring hearing sensitivity or loss.

**Automobile:** A vehicle classification for the purpose of noise prediction modeling, defined as all vehicles with two axles and four wheels designed

primarily for transportation of nine or fewer passengers (automobiles) or transportation of cargo (light trucks). Generally, the gross weight is less than 10,000 pounds.

**Average Level:** Typically the energy-averaged noise level in decibels, wherein the contributing levels are first converted to relative energies or energy ratios, and added and divided by the number of contributing levels. The result is then converted back to decibels.

**A-Weighted Sound Level:** Expressed in dBA or dB(A). Frequency-weighted sound pressure level approximating the frequency response of the human ear. It is defined as the sound level in decibels measured with a sound level meter having the metering characteristics and a frequency weighting specified in the American National Standards Institute Specification for Sound Level Meters, ANSI S 1.4–1983. The A-weighting de-emphasizes lower frequency sound sounds below 1,000 Hz (1 kHz) and higher frequency sounds above 4 kHz. It emphasizes sounds between 1 and 4 kHz. A-weighting is the most commonly used measure for traffic and environmental noise throughout the world.

**Background Noise:** The total noise in a system or situation independent of the presence of (i.e., without) the noise source of interest.

**Baffle:** A shielding structure or series of partitions used to increase the effective external transmission path length between two points in an acoustic system.

**Band:** See “Frequency Band.”

**Band Center Frequency:** The designated geometric mean frequency of a band of noise.

**Band Pressure Level:** The SPL contained within a specified band.

**Barrier Attenuation:** The noise reduction from barrier diffraction only.

**Broadband Noise:** Noise with components over a wide range of frequencies.

**Calibrator:** A device used to calibrate or properly adjust for valid measurement results a sound level meter and microphone system. Calibration must be performed before and after the sound level measurement sequence.

**Community Noise Equivalent Level:** A noise level that accounts for all the A-weighted noise energy from a source during 24 hours, and weights

the evening (7 p.m. to 10 p.m.) and night (10 p.m. to 7 a.m.) noise by adding 5 and 10 dBA, respectively, during these periods.

**Compression:** The portion of a sound wave in which the air molecules are slightly compressed with respect to the barometric air pressure. The opposite of rarefaction.

**Cylindrical Divergence:** Sound waves generated by a line source, such as approximated by a highway, tend to form cylindrical wavefronts that propagate by radiating outward from their original line source in cylindrical pressure waves of ever-increasing areas. This process is referred to as cylindrical divergence or spreading. The same sound energy distributed over an ever-increasing cylindrical area is responsible for reducing the sound's energy per unit area (i.e., intensity) by half for each doubling of distance. This corresponds with a noise level decrease of 3 dB per doubling of distance.

**Cycles per Second:** See "Hertz."

**Day-Night Level:** See " $L_{dn}$ ."

**Decibel:** A decibel is one-tenth of a bel. It is a measure on a logarithmic scale that indicates the squared ratio of sound pressure to a reference sound pressure (unit for sound pressure level) or the ratio of sound power to a reference sound power (unit for sound power level). See also "Sound Pressure Level" and "Sound Power Level."

**Descriptor:** A generic term for a noise indicator such as  $L_{eq}$ ,  $L_{max}$ , or  $L_{dn}$ .

**Diffuse Sound Field:** A sound field in which the time average of the mean square sound pressure is the same everywhere and the flow of acoustic energy in all directions is equally probable. For example, a sound source in a reverberation room, where many reflected sound waves are present and the sound level is equal at any location in the room.

**Diffraction:** The bending of sound pressure waves around an obstacle. The ease with which the pressure waves diffract around an obstacle depends on the ratio of wavelength to the size of the obstacle. Pressure waves with a given wavelength diffract more readily around a small object than a large one. Pressure waves with longer wavelengths diffract more easily around an object of a given size than pressure waves with a shorter wavelength. Because of the above principles, highway traffic noise barriers provide a more defined noise "shadow" behind the barrier and more noise attenuation for higher-frequency noise than lower-frequency noise. See also "Angle of Diffraction" and "Shadow Zone."

**Doppler Effect:** The change in observed frequency of a sound wave caused by a time rate of change in the effective path length between the sound source and receiver. If the path length rate of change causes the source and receiver to approach each other, the observed frequency shifts upward. If the source and receiver recede relative to each other, the frequency shifts downward. The frequency shift is called the Doppler shift, and the unit is hertz.

**Dosimeter:** An instrument measuring noise exposure for compliance with OSHA standards.

**Dynamic Range:** The range in sound levels, in decibels, through which a source or receiver can emit or receive sound. For example, the dynamic range of a sound level meter typically ranges from 20 to 140 dB.

**Emission Level:** A measure of the noise output of a single vehicle. It is the maximum noise level, in dBA, observed during a passby of the vehicle at 50 feet. See also “Reference Energy Mean Emission Level.”

**Energy Average:** The result of energy averaging or a method of averaging various SPLs based on their squared pressures. This method involves the conversion of decibels to equivalent relative energy or energy ratios, averaging the values, and changing the values back to decibels.

**Energy Ratio:** See “Relative Energy.”

**Equivalent Distance:** The distance to a specific receiver from an imaginary single lane that acoustically represents a multilane highway or a group of lanes, such as directional lanes.

**Equivalent Level:** See “ $L_{eq}$ .”

**Excess Attenuation:** Sound attenuation in addition to that caused by geometric spreading. It is usually meant to be the attenuation from ground effects and sometimes atmospheric effects. See also “Geometric Spreading,” “Ground Effects,” and “Atmospheric Effects.”

**Existing Noise Levels:** The noise resulting from the natural and mechanical sources and human activity considered to be usually present in a particular area.

**Far Field:** The region beyond the near field, where the effects of source dimensions are less important and noise propagates with a simple relationship between sound level and distance.

**Filter:** A device for separating components of a signal based on their frequency. It allows components in one or more frequency bands to pass relatively unattenuated and attenuates components in other frequency bands.

**Flanking Noise:** Refers to noise energy that arrives at an observer by an unexpected or unexamined pathway. For example, in the design of noise barriers, the calculations predict the energy that diffracts over the top of the barrier. If significant amounts of noise energy reach the observer by passing around its ends far up and down the roadway, this energy has flanked the barrier along unexpected “flanking paths.”

**Flow Resistivity:** A measure of the acoustical absorption of the ground located between a sound source and receiver. As applied in the FHWA TNM the units of flow resistivity are cgs rayls. Water and hard pavement are highly acoustically reflective and are assigned a flow resistivity value of 20,000 cgs rayls. At the other extreme is power snow which is assigned a value of 10 cgs rayls.

**Free Field:** A sound field that is free from enclosures or boundaries, and in which there are no reflections and accompanying interference and reverberation effects such as found in auditoriums.

**Frequency:** The number of oscillations per second of a periodic wave sound and of a vibrating solid, expressed in units of hertz, formerly cycles per second (cps).  $1 \text{ Hz} = 1 \text{ cps} = 1 \text{ oscillation per second}$ . The value is the reciprocal ( $1/x$ ) of the period of oscillations in seconds. The symbol for frequency is  $f$ .

**Frequency Band:** An interval of the frequency spectrum defined between an upper and lower cutoff frequency. The band may be described in terms of these two frequencies or (preferably) by the width of the band and the geometric mean frequency of the upper and lower cutoff frequencies (e.g., an octave band “centered” at 500 Hz).

**Frequency Response:** The response to an oscillating phenomenon (e.g., sound pressure) by an object (e.g., microphone or ear) measured in decibels as a function of frequency. For example, the A-weighting curve corresponds closely to the frequency response of human hearing at a certain constant level of sound energy. See also “A-Weighted Sound Level.”

**Frequency Spectrum:** The description of a sound wave’s resolution into components of different frequency and usually different amplitude and phase.



**Fresnel Number:** A dimensionless value used in predicting the attenuation of a noise barrier located between a noise source and receiver. In its simplest mathematical form,  $N = 2\delta / \lambda$ , where  $\delta$  is the path length difference between the sound path from the source to receiver via the top of the barrier and the straight line between the source and receiver, and  $\lambda$  is the wavelength of the sound (the units of  $\delta$  and  $\lambda$  must be the same). Generally, the larger the value of  $N$ , the greater the attenuation.

**Fundamental Frequency:** The frequency with which a periodic function (e.g., sound wave) reproduces itself, sometimes called the first harmonic. See also “Harmonic.”

**Geometric Divergence:** Refers to the shape of sound pressure wavefronts and the manner in which they propagate. Geometric divergence or spreading is a generic term used for specific types of divergence, such as cylindrical or spherical divergence. See also “Cylindrical Divergence” and “Spherical Divergence.”

**Gradient:** Variation of speed of sound, temperature, and wind velocity with height above the ground surface. A gradient in speed of sound can be caused by differences in temperature with height above the ground or differences in wind velocities with height above the ground. The speed of sound gradient in turn causes atmospheric refraction of sound which can create noise “shadows” (i.e., decreases) in certain areas and noise concentrations (i.e., increases) in others. See also “(Atmospheric) Refraction.”

**Ground Effects:** The effects of sound grazing absorptive ground. See also “Absorptive Grounds.”

**Hard Site:** Term used for reflective characteristics of the ground surface between a noise source and receiver. The term is most often used in traffic noise prediction models, where it is associated with a 3 dB per doubling of distance line source attenuation (because of geometric spreading only, without excess attenuation).

**Harmonic:** A sinusoidal (i.e., pure-tone) component whose frequency is a whole-number multiple of the fundamental frequency of the wave. If a component has a frequency twice that of the fundamental frequency, it is called the second harmonic.

**Heavy Truck:** A vehicle type for the purpose of noise prediction modeling defined as all vehicles with three or more axles designed for transportation of cargo. Generally, the gross weight is more than 26,500 pounds.

**Hertz:** Unit of frequency, formerly called cycles per second. 1 Hz = 1 cps. See also “Frequency.”

**Hourly Equivalent Sound Level:** See “ $L_{eq}(h)$ .”

**Incident Sound:** Direct sound striking a surface. See also “Angle of Incidence.”

**Infrasound:** A sound with a frequency less than the audible sound spectrum (i.e., generally lower than 16 to 20 Hz).

**Insertion Loss:** The actual noise level reduction at a specific receiver from construction of a noise barrier between the noise source (e.g., traffic) and the receiver. Generally, it is the net effect of the barrier attenuation and loss of ground effects.

**Inverse First Power:** The increasing of sound amplitude from the process of cylindrical divergence from a line source. See also “Cylindrical Divergence.” For a line source, the sound pressure level  $SPL_1$  at distance  $D_1$  is related to the sound pressure level  $SPL_2$  at a distance of  $D_2$  as follows:

$$SPL_1 - SPL_2 = 10\log(D_1 / D_2)$$

**Inverse Square:** The increasing of sound amplitude from the process of spherical divergence from a point source. See also “Spherical Divergence.” For a point source, the sound pressure level  $SPL_1$  at distance  $D_1$  is related to the sound pressure level  $SPL_2$  at a distance of  $D_2$  as follows:

$$SPL_1 - SPL_2 = 10\log(D_1 / D_2)^2$$

**kHz:** Abbreviation for kilohertz, or 1,000 Hz. See also “Hertz.”

**$L_{dn}$ :** Abbreviation for the day-night level noise descriptor. It is the energy average of the A-weighted sound levels occurring during a 24-hour period, with 10 dB added to the A-weighted sound levels occurring from 10 p.m. to 7 a.m.

**$L_{eq}$ :** The equivalent steady-state sound level that in a stated period of time would contain the same acoustical energy as the time-varying sound level during the same period.

**$L_{eq}(h)$ :** The energy-average of the A-weighted sound levels occurring during a 1-hour period in decibels (i.e., a 1-hour  $L_{eq}$ ). See also “ $L_{eq}$ .”

**Level:** In acoustics, the value of a logarithm of the ratio or ratio squared of that quantity  $t$  a reference quantity of the same kind in decibels. The base of the logarithm is commonly 10. The reference quantity and kind of level must be specified (e.g., sound pressure level of 60 dB RE: 20  $\mu$ Pa, sound power level RE:  $10^{-12}$  W).

**Line of Sight:** A straight line between the observer's location and a specific noise source.

**Line Source:** A source of noise spread out into a line, such as approximated by the combined traffic on a roadway.

**$L_{\max}$ :** The highest SPL in a specific time period.

**Logarithm:** A mathematical operation that, for values more than 1, condenses these values into smaller values through the reverse of  $y^x$ , where  $x$  is the number being operated on. Normally, the base, or value of  $y$ , is taken as 10 (common log). If the base is not specified, its value is usually considered 10. Therefore, if  $10^x = a$ , then  $x = \log_{10}a$ , or  $\log a$ . If  $a > 1$ ,  $x$  is positive. If  $a = 1$ ,  $x = 0$ . If  $0 < a < 1$ ,  $x$  is negative. Please note that  $a$  must never be 0. For example:

$$10^2 = 100; \log 100 = 2; x = 2, a = 100$$

$$10^0 = 1; \log 1 = 0; x = 0, a = 1$$

$$10^{-2} = 0.01; \log 0.01 = -2; x = -2, a = 0.01$$

**Loudness:** The judgment of intensity of a sound in terms of which sounds may be ranked on a scale from soft to loud. On this scale, a doubling of a reference sound energy is barely perceptible to the human ear, a tripling of the sound energy is readily perceptible, and 10 times the sound energy is about twice as loud. Decreasing the sound by the same factors has a reciprocal effect—reducing the reference sound energy to one-tenth of the original energy the sound is perceived as half as loud. Although loudness depends primarily on the intensity of the sound, it also depends on the sound's frequency and wave form.

**Loudness Level:** Defined as the median SPL in a specified number of trials of a 1,000-Hz tone that is judged equally loud to the listener as the sound in question. Described in units of phons. Please note that the calculated loudness level,  $L$ , in phons is related to loudness in sones as follows:

$$L = 10\log_2 n_s$$

Where:

L = the loudness level in phons

$n_s$  = loudness in sones

A twofold change in loudness corresponds to an interval of 10 phons. See also “Phon” and “Sone.”

**$L_x$ :** The sound pressure level exceeded  $x$  percent of a specific time period. For example,  $L_{10}$  is the level exceeded 10% of the time, and  $L_{50}$  is the level exceeded 50% of the time.

**Masking:** The action of bringing one sound, audible when heard by itself, to inaudibility or unintelligibility by the introduction of another sound.

**Medium:** A substance carrying a sound wave, such as air, water, or steel.

**Medium Truck:** A vehicle classification for the purpose of noise prediction modeling, defined as all vehicles with two axles and six wheels designed for transportation of cargo. Generally, the gross weight is more than 10,000 pounds and less than 26,500 pounds.

**Meter Response:** Measure of the quickness with which the needle of an analog sound level meter or the display of a digital sound level meter follows changes in the actual sound level.

**Microphone:** An electroacoustic transducer that transforms sound waves into equivalent electric waves.

**Natural Frequency:** Frequency of free oscillation of a system (i.e., the frequency at which a system vibrates when given an initial excitation and allowed to vibrate freely without constraints).

**Near Field:** The part of a sound field, usually within about two wavelengths of the lowest sound frequency from a sound source, in which the dimensions of the sound source have an important effect and where there is no simple relationship between sound level and distance. For traffic noise, the near field usually exists within 25 feet of the nearest traffic. Noise measurements or predictions should be avoided in the near field.

**Noise:** Sound that is loud, unpleasant, unexpected, or otherwise undesirable.

**Noise Barrier:** A generic term for any feature that blocks or diminishes sound in its path from the source to receiver. Although the term can technically refer to any feature, manmade or natural, the two most common features included in noise barriers are soundwalls and earth berms. Almost all noise barriers in California are soundwalls; therefore, the terms “noise barrier” and “soundwall” are frequently interchanged, although soundwalls are a subset of noise barriers. See also “Soundwalls” and “Earth Berms.”

**Noise Contour:** An imaginary line shown on a plan along which all sound levels are equal.

**Noise Floor:** The level of noise, in decibels, that represents the threshold of sensitivity for a sound level meter and below which the inherent (i.e., device’s own) noise limits its detectability of low-level signals.

**Noise Reduction Coefficient:** A value representing the arithmetic average of the absorption coefficients in four octave bands with respective center frequencies of 250, 500, 1,000, and 2,000 Hz.

**Octave:** The interval between two sounds having a frequency ratio of 1:2; (e.g., 500 to 1,000 Hz; 440 to 880 Hz).

**Octave Band:** A frequency band in which the interval between the upper and lower cutoff frequency is one octave. As with all frequency bands, the octave band is usually described by its center frequency. Octave bands are centered by preferred frequencies described by ISO R 266. An example is the 500-Hz octave band. See also “Frequency Band.”

**One-Third Octave:** The interval between two sounds having a frequency ratio of the cube root of 2 (approximately 1.26). Three contiguous one-third octaves cover the same frequency range as an octave.

**One-Third Octave Band:** A frequency band in which the interval between the upper and lower cutoff frequency is one-third of an octave. As with all frequency bands, the one-third octave band is usually described by its center frequency. Three contiguous octave bands make up one octave band. As with octave bands, one-third octave bands are centered by preferred frequencies described by ISO R 266. For example, three one-third octave bands centered at 400, 500, and 630 Hz make up the 500-Hz octave band. See also “Frequency Band.”

**Overall Level:** The SPL that includes all the energy in all frequency bands of interest.

**Pascal:** A unit of pressure (in acoustics, normally rms sound pressure) equal to 1 Newton per square meter ( $\text{N/m}^2$ ). The pascal is abbreviated Pa. A reference pressure for a sound pressure level of 0 dB is 20  $\mu\text{Pa}$ .

**Peak Sound Level:** See “Peak Sound Pressure Level.”

**Peak Sound Pressure:** The maximum instantaneous (i.e., non-rms) sound pressure for a transient or impulsive sound of short duration or in a specified time interval for a sound of long duration. The unit is pascals.

**Peak Sound Pressure Level:** Level of peak sound pressure. The unit is decibels with stated frequency weighting, if any. See also “Peak Sound Pressure” and “Sound Pressure Level.”

**Permanent Threshold Shift:** Permanent hearing loss from frequent exposures to noise of high intensities. See also “Temporary Threshold Shift.”

**Phon:** Unit of loudness judged or calculated in definition of loudness level. See also “Loudness Level.”

**Pink Noise:** Broadband noise that yields the same energy for each octave band over its entire range of frequencies. Because, going from low to high frequencies, each subsequent octave band contains twice the frequency range as the previous band, the energy decreases with increasing frequency to maintain equal energy per octave band. Compare with white noise.

**Point Source:** A noise source essentially concentrated at a single point from which noise propagates outward in all directions. A single vehicle observed from some distance can be approximated as a point source. See also “Spherical Divergence” and “Spreading.”

**Propagation:** The passage of sound energy from a noise source to receiver through a medium (e.g., air).

**Pure Tone:** A sound wave whose waveform is a sine wave (single frequency).

**Random Incidence:** Refers to sound waves that strike the receiver randomly from all angles of incidence. Such waves are common in a diffuse sound field.

**Random Noise:** Noise that has random characteristics in both time and amplitude (i.e., any occurrence of any amplitude is as likely to occur at any one moment as any other).

**Rarefaction:** The portion of a sound wave in which the air molecules are rarefied or in a slight vacuum with respect to the barometric air pressure. The opposite of compression.

**Rate of Decay:** The time rate at which SPL decreases at a given receiver after the sound source is turned off. The commonly used unit is decibels per second (dB/s). It is used in measuring reverberation time of a room. See also “Reverberation” and “Reverberation Time.”

**Receiver:** Most basically defined as any natural or artificial sensor that can perceive, register, or be affected by sound (e.g., human ear, microphone). When modeling noise, a receiver is a point in the model that represents a single receptor or multiple receptors (defined below). For example if three single-family residences are in an area where acoustic conditions are the same, each residence is a receptor. For more modeling purposes the three residences can be represented by a single receiver in the model.

**Receptor:** Most basically defined as any natural or artificial sensor that can perceive, register, or be affected by sound (e.g., human ear, microphone). In the context of a noise analysis under the requirements of 23 CFR 772 a receptor is a single specific dwelling unit or the equivalent of a single dwelling unit. For example in a park with three baseball fields, each field is considered to be equivalent to a single dwelling unit for the purposes of noise analysis.

**Reference Energy Mean Emission Level:** The speed-dependent, energy-averaged maximum passby noise level generated by a defined vehicle type, as measured by a sound level meter at 50 feet from the centerline of travel at a height of 5 feet.

**Reference Pressure:** Any sound pressure to which a test pressure is being compared on a decibel scale, such as in the following expression:

$$\text{dB} = 10 \log_{10} \left( \frac{p_1}{p_0} \right)^2$$

Where:

$p_0$  = reference pressure (usually defined as 20  $\mu\text{Pa}$ ).

Also, the sound pressure at 1,000 Hz that normal young adults can just detect, taken as 20  $\mu\text{Pa}$ .

**Reflection:** Bouncing back of sound waves away from an object that is larger in exposed section than the wavelengths and of sufficient surface

weight, density, and stiffness to present a very large increase in impedance compared to the surrounding air.

**Reflective Ground:** Grounds that do not absorb sound energy and reflect back most of the energy. Examples are paved surfaces (e.g., asphalt, concrete) and hard-packed soils. The opposite of absorptive ground.

**Refraction:** The bending of sound waves in arcing curves either downward or upward because of different velocities of sound with respect to height above the ground. The sound velocity differences are caused either by differences in near-ground wind velocity from wind shear, or vertical changes in temperature (sound velocity increases with air temperature). Downward refraction occurs for downwind sound propagation and during near-ground temperature inversions (temperature increases with height), and is responsible for noise increases. Upward refraction occurs for upwind sound propagation and during near-ground temperature lapses (temperature decreases with height), and is responsible for noise decreases.

**Relative Energy:** The energy ratio between a sound level and reference level. For example, the sound energy of 60 dB is  $10^6$ , or 1,000,000 times larger than that of 0 dB. The sound energy of 67 dB is  $10^{6.7}$ , or 5,011,872 times larger than that of 0 dB.

To add or subtract sound levels, the relative energies (not the decibel levels) may be added directly. Therefore, for the case above, total relative energy is as follows:

$$60 \text{ dB} + 67 \text{ dB} = 1,000,000 + 5,011,872 = \mathbf{6,011,872 \text{ (RE: 0 dB)}}$$

$$10\log(6,011,872) = \mathbf{67.8 \text{ dB.}}$$

The same result would be obtained if a reference of 50 dB were selected, as shown below.

$$50 \text{ dB} + 10\log[10^{(6-5)} + 10^{(6.7-5)}] =$$

$$50 \text{ dB} + 10\log(10^1 + 10^{1.7}) =$$

$$50 \text{ dB} + 10\log(60.12) =$$

$$50 \text{ dB} + 17.8 = \mathbf{67.8 \text{ dB.}}$$

**Resonance:** The relatively large amplitude of sound or vibration produced when the frequency of the source of the sound or vibration “matches” (i.e., synchronizes) with the natural frequency of vibration of an object. See also “Natural Frequency.”



**Resonator:** A device that resounds or vibrates in sympathy with a source of sound and vibration (i.e., the source frequency matches the natural frequency of the resonator).

**Reverberant Field:** The region in a room where the reflected sound dominates, as opposed to the noise source where the direct sound dominates.

**Reverberation:** The persistence of sound in an enclosed space, because of multiple reflections, after the sound source has stopped.

**Reverberation Room:** A room having a long reverberation time, especially designed to make a sound field inside it as diffuse as possible. Also called a live room. The opposite of an anechoic chamber. See also “Anechoic Chamber.”

**Reverberation Time:** The time taken for the sound energy to decrease to one millionth ( $10^{-6}$ ), corresponding to a drop of 60 dB in SPL, of its steady-state value when the sound source is suddenly stopped. It is a measure of the persistence of an impulsive sound in a room and of acoustical absorption present inside the room.

**Root Mean Square Pressure:** The square root of the mean of the squares of a set of instantaneous positive, negative, or zero pressure amplitudes. The rms value is calculated by squaring the pressure values at each instant, adding them, dividing the total by the number of values, and taking the square root of the result. The squaring of both the positive and negative values ensures a positive result. An rms sound pressure is directly correlated with sound energy. For a single-frequency sound or sine wave, there is a simple relationship between the peak sound pressure and rms value:

$$\begin{aligned}\text{Peak} &= \sqrt{2} * \text{rms} \approx 1.414 * \text{rms} \\ \text{rms} &= (1 / \sqrt{2}) * \text{Peak} \approx 0.707 * \text{Peak}\end{aligned}$$

**Shadow Zone:** The area behind a noise barrier that is blocked from direct view of the source of noise on the roadway.

**Shielding:** A noise reduction at the receiver because of the placement or existence of natural or artificial barriers (e.g., walls, berms, rows of buildings, or trees, if thick and dense enough).

**Sine Wave:** A sound wave, audible as a pure tone, in which the sound pressure is a sinusoidal function of time.

**Soft Site:** See “Absorptive Ground.”

**Sound:** A vibratory disturbance created by a moving or vibrating source in the pressure and density of a gaseous, liquid medium or in the elastic strain of a solid that is capable of being detected by hearing organs. Sound may be thought of as mechanical energy of a vibrating object transmitted by pressure waves through a medium to the ears. The medium of main concern is air. Unless otherwise specified, sound will be considered airborne, not structureborne, earthborne, etc.

**Sound Energy:** See “Relative Energy.”

**Sound Insulation:** The use of structures and materials designed to reduce the transmission of sound from one room or area to another, or from the exterior to interior of a building. Also, the degree by which sound transmission is reduced by means of sound-insulating structures and materials.

**Sound Intensity:** The average rate of sound energy transmitted in a specified direction through a unit area normal to this direction at a point considered.

**Sound Level:** Frequency-weighted SPL measured using metering characteristics and frequency weighting, such as A, B, or C, specified in the ANSI Specification for Sound Level Meters.

**Sound Level Meter:** An instrument used for measuring sound levels in a specified manner. It generally consists of a microphone, amplifier, output display, and frequency weighting networks.

**Sound Power:** The total amount of energy radiated into the atmosphere per unit time by a source of sound.

**Sound Power Level:** The level of sound power, averaged over a period of time, the reference being  $10^{-12}$  watts.

**Sound Pressure Level:** Ten times the logarithm to the base 10 of the ratio of the time mean-square pressure of a sound, in a stated frequency band to the square of the reference sound pressure in gasses, of 20  $\mu$ Pa. SPL represents only unweighted rms levels. The unit is decibels. See also “Root Mean Square.”

$$\text{SPL} = 10 \log_{10} \left( \frac{P_1}{P_0} \right)^2$$

Where:

$P_0$  = reference pressure of 20  $\mu\text{Pa}$ .

$P_1$  = sound pressure.

**Source:** A general term designating the sound energy generator. In transportation, noise sources are classified as point and line sources, which have different propagation characteristics. See also “Point Source” and “Line Source.”

**Source Heights:** The effective acoustic height of vehicle noise sources. These heights have been determined from vehicle noise emission data, and are programmed in the appropriate computerized noise prediction models. The heights represent the energy average of all subsources (e.g., exhaust, tires, and engine noise) and are most important in evaluating noise barrier attenuation.

**Sound Transmission Class:** A single figure rating system designed to estimate sound insulation properties of a partition or a rank ordering of a series of partitions. It is intended for use primarily when speech and office noise constitutes the principal problem.

**Spectrum:** See “Frequency Spectrum.”

**Speed of Sound:** The speed of sound for standard temperature of dry air at 32°F and standard air pressure of 29.29 inches Hg standard is 1,087.3 feet per second. From these base values, the variation of speed of sound with temperature is described by the following equations:

$$\text{English Units: } c = 1051.3 \sqrt{1 + \frac{T_f}{459}}$$

Where:

$c$  = speed of sound

$T_f$  = temperature in °F

**Spherical Divergence:** Sound waves generated by a point source, such as approximated by a single vehicle, tend to form spherical wavefronts that propagate by radiating outward from their original point source in spherical pressure waves of ever-increasing areas. This process is referred to as “spherical divergence” or “spreading.” The same sound energy

distributed over an ever-increasing spherical area is responsible for reducing the sound's energy per unit area (intensity) by one-quarter for each doubling of distance. This corresponds with a noise level decrease of 6 dB per doubling of distance. See also "Cylindrical Divergence."

**Spherical Wave:** A sound wave in which the surfaces of constant phase are concentric spheres. A small (point) source radiating into an open space produces a free sound field of spherical waves.

**Steady-State Sound:** Sounds for which average characteristics remain constant in time (e.g., sound of an air conditioner, fan, or pump).

**Structureborne Sound:** Sound that reaches the receiver over at least part of its path by vibration of a solid structure.

**Temporary Threshold Shift:** A temporary hearing loss, evidenced by an increase in the threshold of audibility (see "Threshold of Audibility") occurring after exposure to noise of high intensity. After a given time, usually up to several hours, the ear recovers to almost normal, but not quite so. After an excessive number of exposures of high intensity a hearing loss, or permanent threshold shift develops gradually.

**Threshold of Audibility:** The minimum SPL at which a person can hear a specific sound for a specified fraction of trials.

**Transducer:** A device capable of being actuated by waves from one or more transmission systems or media, and supplying related waves to one or more other transmission systems or media (e.g., microphones, loud speakers, accelerometers, seismometers).

**Transient Sound:** Transient sounds are those whose average properties do not remain constant over time (e.g., aircraft flyover, passing train, sonic boom, gunshot).

**Transmission Loss:** The loss in sound energy at a specific frequency, expressed in decibels, as sound passes through a barrier or a wall. It may be expressed mathematically as:

$$10 \times \text{Log} \left[ \frac{E_1}{E_2} \right]$$

Where:

$E_1$  = sound energy leaving the back of the wall

$E_2$  = sound energy as it strikes the front of the wall

Transmission loss is not a reduction in total energy, only a transformation from sound energy into heat. Almost all highway noise barriers provide a loss of at least 25 dBA, which means that less than 1/3 of a percent of the sound energy travels through the wall.

**Wave:** In acoustics, a propagation wave is a cyclic pressure variation in air. The waves move at a characteristic speed (e.g., the speed of sound) through the medium (e.g., air) as an elastic response to a pressure perturbation at a source.

**Wave Front:** A portion of any wave, whether in compression or rarefaction state, that can be followed as it propagates throughout the medium, analogous to the crest of a tidal wave as it crosses the ocean. At all points on the wave front, the wave has equal amplitude and phase.

**Wavelength:** For a non-periodic wave, such as sound in air, the normal distance between analogous points of any two successive waves. The wavelength of sound in air or water is inversely proportional to the frequency of the sound. Therefore, the lower the frequency, the longer the wavelength.

**White Noise:** Broadband noise, the energy of which is constant over a wide range of frequencies (i.e., energy/Hz = constant). Because each octave band range increases by a factor of two, from low to high frequencies, each subsequent octave band contains twice the acoustical energy as the previous one. This corresponds to an increase of 3 dB in energy for each subsequent octave band. Compare with “Pink Noise.”

**Ultrasonic:** Pertaining to sound frequencies above the audible sound spectrum (in general, more than 20,000 Hz).

*This page intentionally left blank*

Appendix A  
**References Cited**

*This page intentionally left blank*



## Appendix A

# References Cited

- American Association of State Highway Transportation Officials. 2011. Draft Standard TP 99-12. *Determining the Influence of Road Surfaces on Traffic Noise Using the Continuous-Flow Traffic Time-Integrated Method (CTIM)*. Washington, DC.
- . 2012. Standard Method of Test for Measurement of Tire/Pavement Noise using the On-Board Sound Intensity (OBSI) Method. Washington, DC.
- American National Standards Institute. 1983. *American National Standard Specification for Soundlevel Meters*. New York, NY.
- California Department of Transportation. 1995. *Traffic Noise Attenuation as a Function of Ground and Vegetation*. Final Report. Sacramento, CA.
- . 1998. *General Guidelines for Studying the Effects of Noise Barriers on Distant Receivers*. Sacramento, CA.
- . 2002. *Distance Limits for Traffic Noise Prediction Models*. Technical Advisory, Noise TAN-02-02. Prepared by Hendriks, R. for the Division of Environmental Analysis, Sacramento, CA.
- . 2003. *Additional Calibration of Traffic Noise Prediction Models*. Technical Advisory, Noise TAN-03-01 Final. Prepared by Hendriks, R., for the Division of Environmental Analysis.
- . 2004. *Transportation- and Construction-Induced Vibration Guidance Manual*. Prepared by Jones & Stokes for California Department of Transportation Environmental Program – Noise, Vibration, and Hazardous Waste Management Office, Sacramento, CA.
- . 2009. *Technical Guidance for Assessment and Mitigation of the Hydroacoustic Effects of Pile Driving on Fish*. Final. Prepared by ICF

- Jones & Stokes and Illingworth and Rodkin, Inc., for California Department of Transportation, Sacramento, CA.
- . 2013. *Traffic Noise Analysis Protocol for New Highway Construction, Reconstruction Projects, and Retrofit Barrier Projects*. September.
- Dooling, R. J. and A. N. Popper. 2007. *The Effects of Highway Noise on Birds*. Rockville, MD.
- Federal Highway Administration. 1978. *Highway Traffic Noise Prediction Model*. Report FHWA-RD-77-108. Washington, DC.
- . 1996a. *Measurement of Highway-Related Noise*. Report FHWA-PD-96-046. Washington, DC.
- . 1996b. *Development of National Reference Energy Mean Emission Levels for the FHWA Traffic Noise Model (FHWA TNM®), Version 1.0*. Report No. FHWA-PD-96-008/DOT-VNTSC-FHWA-96-2. U.S. Department of Transportation, Research and Specialties Program.
- . 2004. *Synthesis of Noise Effects on Wildlife Populations*. Report FHWA-HEP-06-016. Washington, DC.
- . 2006. *FHWA Roadway Construction Noise Model User's Guide*.
- . 2007. *The Little Book of Quieter Pavement*. Washington, DC.
- . 2011. *Highway Traffic Noise: Analysis and Abatement Guidance*. Washington, DC.
- Fleming G. G., A. S. Rapoza, and C. S. Y. Lee. 1995. *Development of National Reference Energy Mean Emission Levels for the FHWA Traffic Noise Model (FHWA TNM®) Version 1.0*. Report No. FHWA-PD-96-008/DOT-VNTSC-FHWA-96-2. John A. Volpe National Transportation Research Center, Acoustics Facility, Cambridge MA. U.S. Department of Transportation, Research and Special Programs Administration.
- Fleming, G. G., H. S. Knauer, C. S. Y. Lee, and S. Pederson. 2011. *FHWA Highway Noise Barrier Design Handbook*. Prepared for U.S. Department of Transportation, Federal Highway Administration.
- Harris, Cyril M. 1979. *Handbook of Noise Control*. McGraw-Hill, Inc.

- Hoover & Keith. 2000. *Noise Control for Buildings, Manufacturing Plants, Equipment, and Products*. Houston, TX.
- Illingworth & Rodkin, Inc. 2006. *Comparative Measurements of Tire/Pavement Noise in Europe and the United States Noise Intensity Testing in Europe (NITE) Study*.
- . 2011a. *I-80 Davis OGAC Pavement Noise Study*. Petaluma, CA.
- . 2011b. *Eight Year Evaluation of the Noise Performance of the Caltrans Asphalt Research Pavements on LA 138*. Petaluma, CA.
- . 2011c. *Initial and Long-Term Evaluation of the Tire-Pavement Noise Produced by Various Portland Cement Concrete Surface Textures Measurements on the State Route KN 58 Mojave Bypass 2003 to 2010*. Petaluma, CA.
- National Cooperative Highway Research Program. 2009. NCHRP Report 635 Acoustic Beamforming: Mapping Sources of Truck Noise. Washington, DC.
- . 2011a. NCHRP Project 1-44: Measuring Tire-Pavement Noise at the Source. Washington, DC.
- . 2011b. NCHRP Project 1-44 (1) Measuring Tire-Pavement Noise at the Source: Precision and Bias Statement. Washington, DC.
- . 2011c. *Research Results Digest 363 - Hydroacoustic Impacts on Fish from Pile Installation*. Washington, DC. Renterghem, T. V. and D. Botteldooren. *Optimal Tree Canopy Shape for Improving Noise Barrier Efficiency*. University of Ghent, Belgium.
- Rochat, J. L., D. R. Read, G. G. Fleming, and G. Gregg. *Caltrans Thin Lift Study: Effects of Asphalt Pavements on Wayside Noise*. Volpe National Transportation Systems Center. Cambridge, MA.
- Rymer, B. and P. Donovan. 2011. *Determining End Limits of Quieter Pavement Projects*. Petaluma, CA. Sandberg, Ulf and Jerzy Ejsmont. 2002. *Tyre/Road Noise Reference Book*, INFORMEX Ejsmont & Sandberg Handelsbolag, Kisa, Sweden.
- Shatnawi, S. 2009. Caltrans Memorandum—Quieter Pavement Bulletin. Available:  
<[http://www.dot.ca.gov/hq/maint/Pavement/Offices/Pavement\\_Engineering/PDF/QP\\_Memo\\_Bulletin\\_Oct-15-09.pdf](http://www.dot.ca.gov/hq/maint/Pavement/Offices/Pavement_Engineering/PDF/QP_Memo_Bulletin_Oct-15-09.pdf)>. Accessed September 2013.

Woehner, Helmut. 1992. Sound Propagation at Tunnel Openings. *Noise Control Engineering Journal* 39(2).