



## **REDUCING BIRD COLLISIONS WITH BUILDINGS AND BUILDING GLASS BEST PRACTICES**

US FISH AND WILDLIFE SERVICE  
DIVISION OF MIGRATORY BIRD MANAGEMENT  
FALLS CHURCH, VIRGINIA

JANUARY 2016  
UPDATED JULY 2016

## Table of Contents

OVERVIEW .....	2
<i>THE ISSUE</i> .....	2
<i>THE AVOIDANCE/MINIMIZATION OPTIONS</i> .....	2
GLASS OPTIONS .....	3
CREATE YOUR OWN PATTERN.....	3
INSTALL A SPECIAL FILM, GLASS OR COVERING.....	5
<i>External Films and Coverings</i> .....	5
<i>Fritted Glass</i> .....	5
<i>Ultraviolet Patterned Glass</i> .....	6
<i>Screens and Netting</i> .....	6
<i>Architectural Features</i> .....	6
LIGHTING OPTIONS .....	8
LIGHTING DESIGN.....	8
LIGHTING OPERATION.....	8
LANDSCAPING OPTIONS .....	9
EXTERIOR.....	9
INTERIOR .....	9
IMPLEMENTATION .....	10
MEASURES FOR A RESIDENCE .....	10
<i>Assess your home's risk for bird collisions</i> .....	10
<i>Implement Measures</i> .....	11
MEASURES FOR COMMERCIAL AND INSTITUTIONAL BUILDINGS.....	12
<i>Assess your building's risk for bird collisions</i> .....	12
<i>Implement Measures</i> .....	13
<i>Educate Others</i> .....	14
MEASURES FOR NEW BUILDINGS, BUILDING RENOVATIONS AND RETRO-FITS .....	14
REFERENCES .....	15

### A Special Thanks to Our Contributors!

U.S. Fish & Wildlife Service would like to extend a special note of appreciation to the number of highly knowledgeable experts and authorities on bird interactions with building, glass and lighting infrastructure that contributed to the content and review of this document. This product is a true representation of the power of partnerships and coordination across agencies and institutions. This document will continue to be updated with the best available information, and our partnerships with experts in the field will be critical in making that happen. Thanks to all of you for the important work you do for bird conservation!

## OVERVIEW

The U.S. Fish and Wildlife Service (Service) has responsibility to protect and conserve migratory birds as part of four international treaties (Mexico, Japan, Canada, and Russia) and the Migratory Bird Treaty Act. As part of this mission, the Service is working to address human-caused sources of mortality by developing and providing information on options for reducing hazards to migratory birds. Bird collisions associated with building glass and building lighting are hazards where a variety of potential avoidance and minimization options exist. This document is intended to provide straight-forward options for reducing bird collisions with buildings by offering recommendations for simple, no cost building occupant best practices; low cost avoidance and minimization actions; and strategies for new buildings, building renovations, and building retro-fits.

### *THE ISSUE*

Birds generally do not see clear or reflective glass (Klem and Saenger 2013). Glass reflectivity and transparency create a lethal illusion of clear airspace that birds do not see as a barrier. During the daytime, birds collide with windows because they see reflections of the landscape in the glass (e.g., clouds, sky, vegetation, or the ground); or they see through glass to perceived habitat (including potted plants or vegetation inside buildings) or to the sky on the other side. At night, during spring and fall bird migrations when inclement weather occurs, birds can be attracted to lighted structures resulting in collisions, entrapment, excess energy expenditure, and exhaustion (Manville 2009). This phenomenon has resulted in a number of concentrated avian mortality events. These mass events are less common at city, office or residential buildings, but still a possibility under the right weather and lighting conditions. The majority of collisions with both residential and urban buildings happen during the day, as birds fly around looking for food. Large avian mortalities at night more frequently occur at communication towers, offshore drilling platforms and in other situations where there is a bright light source in a dark area, especially during inclement weather.

Annual bird mortality resulting from window collisions in the U.S. is estimated to be between 365-988 million birds (Loss et al. 2014). While most people consider bird/glass collisions an urban phenomenon involving tall, mirrored-glass skyscrapers, the reality is that 56% of collision mortality occurs at low-rise (i.e., one to three story) buildings, 44% at urban and rural residences, and <1% at high-rises (Loss et al. 2014).

In an effort to reduce bird collisions with building glass, the Service's Division of Migratory Bird Management has compiled the following list of best practices and best available technologies. These best practices are grouped into measures that can be implemented at residences and office buildings, and provides options for both new buildings, and for existing building renovations and retro-fits. Many of these measures not only provide protection to birds, but also provide energy and cost savings to building owners.

### *THE AVOIDANCE/MINIMIZATION OPTIONS*

The Service recommends the following options to avoid and minimize bird/glass collisions. Any mention of trade names or commercial products in this document or the documents or websites referenced within does not constitute endorsement or recommendation by the Federal government. Readers should be aware that each product has benefits and limitations. Users of these products should work with technical experts to determine which specific product may work best for a particular application.

## GLASS OPTIONS

There are a variety of glass and window design options that can be integrated into building designs to reduce mortality from bird collisions. The goal of these glass options is to create a visual signal or cue to help birds detect and avoid glass. To make an effective virtual cue, all window treatment should be applied to at least the first two to three stories or the height of the adjacent vegetation. However, applying treatments to just the first story windows or known problem windows can be helpful as well.

### Create Your Own Pattern

The key to creating bird-friendly glass is to increase visual noise on the surface of the glass. Visual noise is a visible pattern that breaks up transparent or reflective areas of glass enough that birds perceive they cannot fit through the transparent or reflective areas. There is still research needed to determine the most effective dimensions of various visual patterns on glass for bird strike prevention. However, in general, vertical stripes that are at least 1/4 inch wide with a maximum spacing of 4 inches, and horizontal stripes that are at least 1/4 inch wide with a maximum spacing of 2 inches have been effective at preventing strikes of most birds (Sheppard 2011; Klem 2009). Because hummingbirds are so much smaller than other birds, closer spacing of the elements of any pattern (striped or otherwise) will be necessary. Also, when using patterns other than stripes, closer spacing of elements is recommended because a series of smaller images like dots will not break up the glass as much as stripes using the 2" X 4" spacing rules.

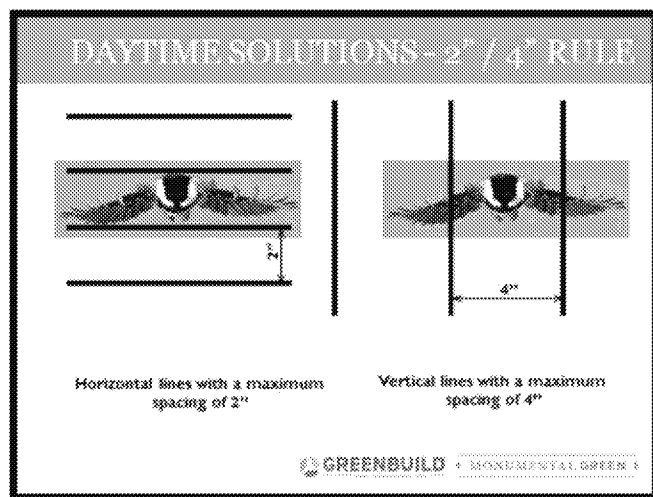

The image shows how pattern spacing on glass can work to deter birds. Images by ABC and Roy Handcliff

Pattern color contrast is important as well. Use colors that contrast well against the background or reflections (e.g., white stripes may be more effective than black stripes if there is a consistent reflection of dark color on the glass surface). The image to the right depicts the importance of the contrast between the color of the window pattern and the background. Notice that the white stripes are significantly more visible than the black stripes with the dark reflections on this window.

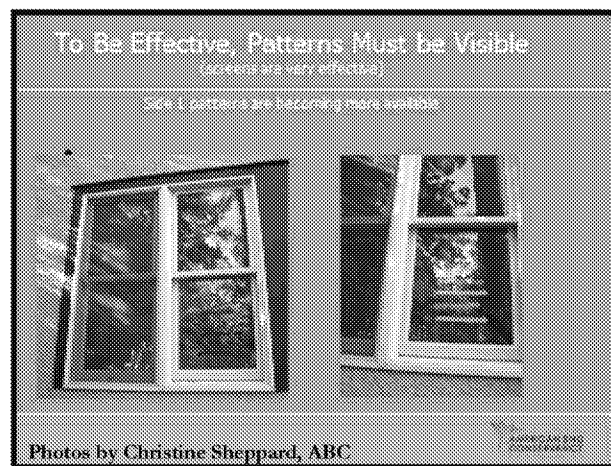

Applying a product to the outer surface (surface #1) of the glass is always most effective. Applying a product to surface #2 or #3 (inner surfaces) can be effective if surface #1 is not so reflective that the pattern beneath is not visible to birds(see Fig. 1).

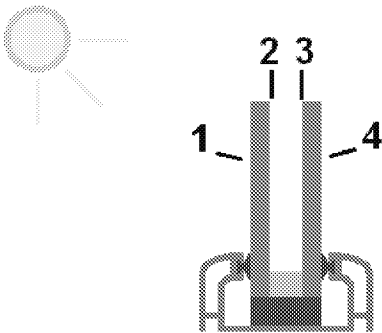

Image by NeLean/CC BY

Fig 1: Window Surface Diagram – Depicts surface #1 (outside facing pane), surface #2 (inside of outside facing pane), surface #3 (inside of inside facing pane and) and surface #4 (inside facing pane).

This image shows an example of a striped glass pattern that can be effective for preventing strikes of most birds (smaller spacing may be needed for hummingbirds). This particular pattern has been applied to the exterior surface (surface #1) of the window.



Striped glass pattern. Photo by Christine Sheppard, ABC

This image shows an example of non-striped pattern that can be effective for preventing strikes of most birds (smaller spacing may be needed for hummingbirds). This pattern has also been applied to the exterior surface (surface #1) of the window.

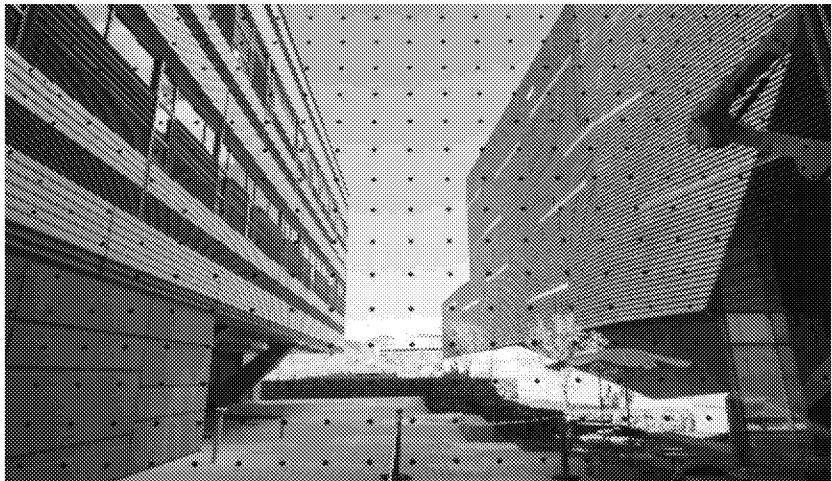

Dot pattern applied to the exterior of a National Renewable Energy Laboratory (NREL) building to help prevent bird collisions. Dots are approximately 1/2" in diameter spaced 2" vertically and horizontally. Photo by Dennis Schroeder, NREL 31193

There are several ways you can create your own patterns on glass. To see recommendations for creating your own patterns on glass, visit the ***Solutions and Materials*** section of the Bird-Safe Glass Foundation resources webpage (<http://www.birdsafeglassfoundation.org/contact-us/resources/>).

## Install a Special Film, Glass or Covering

### ***External Films and Coverings***

There are several effective external film and glass covering options. Some options are more expensive, but are highly effective. Films are good for retrofit applications. A drawback, however, is that they only have a guarantee lifetime of 5 to 7 years, although they may last longer. To see a list of the latest recommendations in external films and covering products, visit the ***Solutions and Materials*** section of the Bird-Safe Glass Foundation resources webpage (<http://www.birdsafeglassfoundation.org/contact-us/resources/>).



A bird friendly film was applied at the entrance of the Ding Darling Education Center at the J. N. "Ding" Darling National Wildlife Refuge. Photo shows entrance before (left) and after (right) application. Photos by USFWS

### ***Fritted Glass***

Fritting is the use of ceramic lines, dots or patterns that are most often placed on the #1 surface (outside-facing pane) or #2 or #3 (interior panes) (see [Fig. 1](#)) of insulated glass. Fritting is a commonly used measure, but is more expensive than other types of window coverings. This technique allows humans to see through the glass while reducing the transparency of the glass. It also provides energy savings by reducing heat gain, while still allowing day-lighting of buildings (Sheppard 2011). To see a list of the latest recommendations in fritted glass products, visit the ***Solutions and Materials*** section of the Bird-Safe Glass Foundation resources webpage (<http://www.birdsafeglassfoundation.org/contact-us/resources/>).



### ***Ultraviolet Patterned Glass***

Birds see in the ultraviolet (UV) spectrum so using glass that reflects UV light in a pattern can reduce bird collisions. While this glass is typically more expensive than other treatments, it is comparable in price to other energy-efficient glass (Eisenberg 2010). As of 2015, few UV patterned products are available. However, this option may be desired when seeking a product that is generally not visible to humans, but provides some benefit to birds. To see a list of the latest recommendations in ultraviolet patterned glass products, visit the ***Solutions and Materials*** section of the [Bird-Safe Glass Foundation resources webpage](http://www.birdsafeglassfoundation.org/resources) (<http://www.birdsafeglassfoundation.org/contact-us/resources/>).

### ***Screens and Netting***

Installing external screens or netting on windows is an effective and relatively inexpensive treatment. Screens reduce reflection and injury by providing a cushion between the bird and the window. This treatment can be installed on individual panes or attached to a façade. To be effective, the netting must be placed far enough in front of the window that a bird hitting it will not collide into the glass behind. The netting should have openings no larger than ½ inch. Several companies sell screens or other barriers that can be attached with suction cups or eye hooks. These treatments can be used on new construction, renovations, and retro-fits. To see a list of the latest recommendations in screen and netting products, visit the ***Solutions and Materials*** section of the [Bird-Safe Glass Foundation resources webpage](http://www.birdsafeglassfoundation.org/resources) (<http://www.birdsafeglassfoundation.org/contact-us/resources/>).

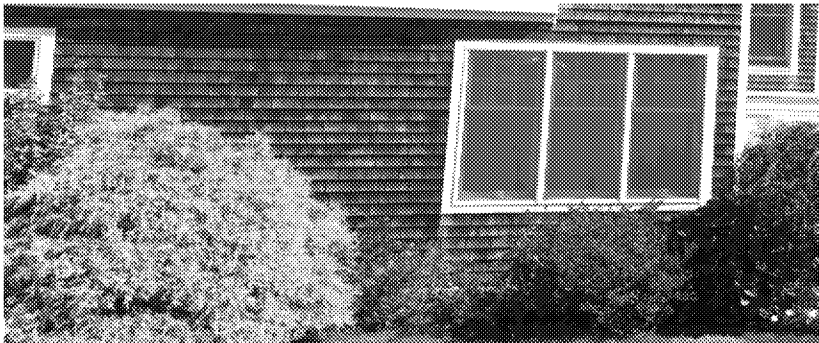

Basic home window screen. Photo by Christine Sheppard, ABC



Window netting installed feet from window on slanted wooden beams. Photo by USFWS

## *Architectural Features*

Building designers can use features such as overhangs, shutters, louvers, mesh and awnings to reduce glass reflections or reduce visibility into transparent areas.



Shading was applied around the windows on the exterior of the Research Support Facility (RSF) at the National Renewable Energy Laboratory (NREL) to reduce glare and overheating of the building interior. These windows are also bird friendly. Photo by Dennis Schroeder, NREL 19798



Shutters overhang windows at a facility at the San Diego Zoo. Photo by Christine Sheppard, ABC



## LIGHTING OPTIONS

Eliminating or reducing unnecessary lighting is one of the easiest ways to reduce collisions while also saving energy and reducing costs to building owners. Note that these measures will not eliminate collisions, and their effectiveness is highly dependent on local conditions, including the degree of bird friendly design and practices of neighboring buildings.



### Lighting Design

- a. Avoid unnecessary lighting, including perimeter lighting.
- b. Install motion sensors on all lights (both interior and exterior) that activate only when people are present. Motion sensors are fairly inexpensive and save energy. This is especially important during the bird migration periods (early April through late May and mid-August through early November), and periods of inclement weather.
- c. Ensure all exterior lighting is “fully shielded” so that light is prevented from being directed skyward. “Fully shielded” light fixtures are defined as those with an opaque shield so that all light is emitted below the lowest light emitting part of the fixture. “Fully shielded” is the same as “zero up light” and “dark sky compliant”. See [Appendix A](#) for examples of acceptable fixtures.
- d. Comply with all Federal Aviation Administration obstruction and marking guidelines by ensuring that required obstruction lighting is comprised of only L-864 strobe lights with appropriate flash rates and extinguish all steady burning L-810 lights ([FAA 2007](#), Patterson 2012).

### Lighting Operation

- a. Ensure that any lights that are not motion-activated are turned off at night; especially architectural lighting, upper story interior lighting, and lobby or atrium lighting.
- b. Eliminate the use of decorative/vanity lighting during the bird migration periods (early-April through late May and mid-August through early November). This includes upward directed spot- and flood-lights, and roof-top lighting.
- c. “Lights Out” programs exist throughout major cities across the country to encourage buildings to reduce light pollution during migration. For more information visit Audubon’s [Existing Lights Outs Programs](#) webpage (<https://www.audubon.org/conservation/existing-lights-out-programs>).
- d. Install window coverings to prevent light spill.

## LANDSCAPING OPTIONS

### Exterior

- Where habitat is adjacent to, seen through or reflected in any glass structures (e.g., windows, bus shelters, guard rails, glass walls, etc.), treat the glass using one of the [Glass Options](#) listed above. Avoid creating an effect where landscaping funnels birds towards glass panes (e.g., walkways, passageways, edges) or where approaches to a building (vehicles or people) flush birds towards windows.



An example of where trees and shrubs are reflected in the glass and create a type of funnel effect near the entrance of a building. Photo by USFWS

- Avoid using glass in supplemental structures (e.g., bus shelters, guard rails, glass walls, etc.). When it is not possible to avoid using glass for these structures, use only highly effective [Glass Options](#) to treat these structures. See the [Solutions and Materials](#) section of the [Bird-Safe Glass Foundation resources webpage](http://www.birdsafeglassfoundation.org/resources/) (<http://www.birdsafeglassfoundation.org/contact-us/resources/>) for a list of tested materials and their product effectiveness rating.

### Interior

- If you have indoor plants, trees or shrubs, either treat the adjacent glass or move all plants away from clear glass windows far enough that they can't be seen from the outside by birds. If you were at window level looking in, could you see the plant? If the answer is “yes”, then birds can probably see it too.



An example of where a potential bird hazard has been created by placing plants inside of a building near the window. Photo by USFWS

## IMPLEMENTATION

### Measures for a Residence

#### *Assess your home's risk for bird collisions*

Not all windows are equally hazardous. The most hazardous windows are likely those that are most reflective of bird habitat (e.g., trees, shrubs, flowers, sky), and closest to areas where you see birds when they are active.

Professional assistance is available to assess your home's risk for bird impacts, and to identify specific problem areas and apply avoidance/minimization measures. However, these services are likely at a cost to the homeowner. One example of this type of service is the Fatal Light Awareness Program (FLAP), which offers a risk assessment service for this purpose. To learn more about this service, visit the [FLAP BirdSafe Building Risk Assessment website](http://www.flap.org/bird-safe-consulting.php) (<http://www.flap.org/bird-safe-consulting.php>) and contact their assessment team to see if a local assessment can be arranged. You can also pinpoint problem areas by conducting regular monitoring around your home for dead or injured birds, or noting where you observe collisions.

You can also do your own assessment by conducting regular monitoring around your home, especially in areas that are potentially problematic. Monitoring can identify problem areas and tell you how frequent collisions occur. Monitoring is recommended even after collision prevention measures have been applied to ensure treatments are working. To monitor around your house, follow these basic steps in the early morning (around 8am or before) at least a few times a week and daily, if possible, during bird migration periods (early April through late May and mid-August through early November):

1. Walk around your house looking at the ground below windows for dead birds;
2. Inspect each window for feather spots or bird imprints; inspect windows daily when bird feeders are in use;
3. If you find an injured bird, per 50CFR 21.31(a), you may pick it up only if you intend to take it immediately to a rehabilitator. If the bird is dead, or you do not intend to take the bird to a rehabilitator, you should not attempt to handle the bird, unless you are permitted to do so. If necessary, contact a wildlife official or agency or local licensed wildlife pest control company that is permitted for the possession, handling, transport, and disposal of migratory birds.
4. If helpful, maintain a personal log of information about any dead or injured birds you find during your searches including the species and locations where the birds were found. Logs can be useful for helping you remember where collisions occur and revealing recurring problem areas over time.

Basic guidance for monitoring can be found in the ***Monitoring*** section of the [Bird Safe Glass Foundation resources webpage](http://www.birdsafeglassfoundation.org/contact-us/resources/) (<http://www.birdsafeglassfoundation.org/contact-us/resources/>).

## ***Implement Measures***

After you have identified which windows may be causing bird collisions, you should follow the steps below to reduce the risk of collision.

### **1. Ensure proper operation of window covers**

Proper operation of window covers can help reduce bird collisions, but should be paired with a window treatment using one of the [Glass Options](#) listed above for optimal results.

- **If you have blinds**, keep them partially opened during the daytime when birds are concentrated, especially during bird migration periods (early April through late May and mid-August through early November), and closed completely at night. A partially open blind during the day will appear as a striped pattern that can break up reflections.
- If, during the day, you notice birds are still colliding, it may mean a reflection is still occurring, and you should consider an exterior window treatment.
- **If you have shades**, apply a pattern to the shade on the window side and keep them closed as much as possible during the day, particularly when the room is not in use. Use strong contrasting colors in the design so the bird can see it through the window and any reflection. At night, close them completely to keep the escape of indoor lighting to a minimum.



Photo by Elf/ WC PD

### **2. Apply a window treatment**

Exterior treatments applied on the outside of see-through windows and reflective glass is the most effective action to prevent bird-glass collisions. However, applying treatments on the inside can also be helpful. If you can see the markings from the outside of the window from window level, birds probably can too. Check this several times during the day, as reflections may only occur during certain light conditions. See options under [Glass Options](#) for a list of window treatment options for existing structures.

### **3. Distance bird feeders appropriately**

Once you have treated your glass, be sure to place your bird feeder 3-feet or less from your windows; the closer, the better.

### **4. Reduce light trespass**

You can reduce light trespass into the environment with appropriate lighting structures and operation (refer to items under [Lighting Options](#)).

### **5. Follow landscaping best practices**

Following landscaping best practices will ensure a hazardous condition is not created (refer to items under [Landscaping Options](#)).

## Measures for Commercial and Institutional Buildings

Avoiding or reducing bird collisions with windows for commercial and institutional buildings can be challenging. First, office buildings have a wide range of architectural styles, floor levels, size, type and configuration of windows. All of these factors influence the risk of bird collisions. Second, occupants of commercial and institutional buildings may not own the building, making actions to reduce collisions more difficult. However, whether you own the building or are simply a building occupant, there are a number of measures you can take to make your building more bird friendly.

The following measures will help reduce bird attraction to your building, and many of them will save in overall building maintenance and energy costs.

### ***Assess your building's risk for bird collisions***

Professional assessments are available to assess your building's risk for bird impacts and for identifying specific problem areas (note: this is likely at a cost). The Fatal Light Awareness Program (FLAP) offers a risk assessment service for this purpose. To learn more about this service, visit the [FLAP BirdSafe Building Risk Assessment website](http://www.flap.org/bird-safe-consulting.php) (<http://www.flap.org/bird-safe-consulting.php>) and contact their assessment team to see if a local assessment can be arranged. There are also several ways to conduct your own assessment to identify potential problem areas. Not all windows are equally hazardous. Check to see which of your windows are most reflective of bird habitat (e.g., trees, shrubs, flowers, sky), and closest to areas where you see birds when they are active. You can also use direct observations of collisions (e.g., dead birds, feather prints on windows, etc.) to pinpoint problem areas.

An effective and recommended way to identify and verify problem areas is by monitoring regularly around your building for dead or injured birds, especially in areas that are potentially problematic. Monitoring can help you track and confirm where regular collisions are occurring and help you influence changes in these areas (e.g., moving plants away from windows) or open a dialogue with building management for where collision prevention measures may be necessary. Monitoring is recommended even after collision prevention measures are applied to ensure treatments are working properly. When establishing your monitoring program, follow these basics steps:

- Consider establishing a standardized monitoring plan that all employees helping with the monitoring effort can follow. Assign people to certain days and times, and map out the route to follow. It is suggested monitoring be done at least once in the early morning (around 8am or before) a few times a week and daily, if possible, during bird migration periods (early April through late May and mid-August through early November).
- Collect information about any dead or injured birds that employees report or find during building searches in a personal log. Logs can be useful for revealing recurring problem areas over time, and can help communicate and support why and where avoidance and minimization measures may be necessary to those who will need to assist in implementing these measures (e.g. building managers, building tenants).

- If you find an injured bird, per 50CFR 21.31(a), you may pick it up only if you intend to take it immediately to a rehabilitator. If the bird is dead, or you do not intend to take the bird to a rehabilitator, you should not attempt to handle the bird, unless you are permitted to do so. If necessary, contact a wildlife official or agency or local licensed wildlife pest control company that is permitted for the possession, handling, transport, and disposal of migratory birds.

Basic guidance for monitoring, including suggested fields to be included in a tracking spreadsheet can be found in the **Monitoring** section of the [Bird Safe Glass Foundation resources webpage](http://www.birdsafeglassfoundation.org/contact-us/resources/) (<http://www.birdsafeglassfoundation.org/contact-us/resources/>).

### ***Implement Measures***

After you have identified which windows may be causing bird collisions, you should follow the steps below to reduce the risk of collision.

#### **Use Window Covers (Blinds and Shades)**

Window covers should be paired with a window treatment using one of the [Glass Options](#) listed above for optimal results in helping reduce bird collisions.

- **If you have blinds**, keep them partially opened during the daytime when birds are concentrated, especially during bird migration periods (early April through late May and mid-August through early November), and close them completely at night. A partially open blind during the day will appear as a striped pattern that can break up reflections. If, during the day you notice birds are still colliding, it may mean reflection is still occurring, and you should consider an outside window treatment.
- **If you have shades (and it is OK with building management to do so)**, apply a pattern to the shade on the window side and keep them closed as much as possible during the day, particularly when the room is not in use. Use strong contrasting colors in the design so the bird can see it through the window and any reflection. At night, close them completely to keep the escape of indoor lighting to a minimum.

#### **Avoid or Minimize Evening Lighting**

- **Building Occupants** – If the lights are on when you are leaving for the evening, turn the lights off, especially in windowed offices, and encourage others to do the same.
- **Building Owners** – Conduct building cleaning during the daytime. This will reduce bird incidents at night and provide energy and cost savings. Daytime cleaning may also result in salary savings by eliminating nighttime overtime cleaning costs.

#### **Avoid or Minimize Interior Landscaping**

If you have indoor plants, trees and shrubs, move them away from clear glass windows far enough that they can't be seen from outside by birds. If you can see the plant standing at window level and looking in, then birds can probably see it too.

### **Apply a Window Treatment or Barrier**

If you are a building occupant, this is something you will likely have to work with building management to approve and implement since it requires modification of the building windows. However, if it is an option, exterior treatments applied on the outside of see-through windows and reflective glass is the most effective action to prevent bird-glass collisions. If exterior treatments are not an option, applying treatments on the inside can also be helpful. If you can see the markings from the outside of the window at window level, birds probably can too. Check this several times during the day, as reflections may only occur during certain light conditions See items under **Glass Options** for a list of window treatment options for existing structures.

### ***Educate Others***

Take steps to educate building owners and occupants about the risk of bird collisions and the simple steps that can be taken to reduce collisions such as turning off lights and closing window coverings at night.

## **Measures for New Buildings, Building Renovations and Retro-fits**

### ***Building Design***

- Follow the LEED Pilot Credit 55: Bird Collision Deterrence recommendations for new construction (<http://www.usgbc.org/Docs/Archive/General/Docs10402.pdf>).
- Minimize the number of, or co-locate roof-top antennas. Make all antennas free standing (i.e., no guy wires).
- Use architectural features to reduce the amount, reflectivity, and transparency of glass.
- If clear glass corridors, skyways, walkways, or courtyards are proposed it is imperative to use bird collision mitigation measures.

### ***Glass Design/Pattern***

- Avoid over-use of glass: keep the percentage of total glass below American Society of Heating, Refrigerating, and Air-Conditioning Engineers (ASHRAE) standard of 40% of surface area (ANSI/ASHRAE/IES Standard 90.1 2013).
- Use smaller pane sizes – less than 2.5 square meters - when possible.
- Do not use reflective glass. Use opaque, etched, or patterned glass that meets the suggested pattern dimensions, or has a Materials Threat Score of less than 30 (see LEED Pilot Credit 55: Bird Collision Deterrence; U.S. Green Building Council 2011). Refer to items 1-6 under Glass Options for glass and window design and treatment recommendations.

### ***Lighting***

- Refer to items under Lighting Options for best practice recommendations for lighting design and operation.

### ***Landscaping***

- Refer to items under Landscaping Options for landscaping best practices.

## REFERENCES

- ANSI/ASHRAE/IES Standard 90.1. 2013. Energy Standard for Buildings Except Low-Rise Residential Buildings. <https://www.ashrae.org/resources--publications/bookstore/standard-90-1>
- Eisenberg, A. 2010. Warning to Birds: All-Glass Buildings Ahead. New York Times. Aug. 28, 2010.
- Federal Aviation Administration. 2007. Advisory Circular: Obstruction marking and lighting. AC70/7460-1K.
- Fatal Light Awareness Program (FLAP).
- Klem, D. 2009. Preventing Bird-Window Collisions. *Wilson Journal of Ornithology* 121(2): 314-321.
- Klem, D. and P. G. Saenger. 2013. Evaluating the Effectiveness of Select Visual Signals to Prevent Bird-window Collisions. *The Wilson Journal of Ornithology* 125(2):406-411.
- Loss, S.R., T. Will, S.S. Loss, and P.P. Marra. 2014. Bird-building collisions in the United States: estimates of annual mortality and species vulnerability. *Condor* 116: 8-23.
- Manville, A.M. 2009. Towers, turbines, power lines, and buildings – steps being taken by the U.S. Fish and Wildlife Service to avoid or minimize take of migratory birds at these structures. In *Tundra to tropics: Connecting habitats and people*. Proceedings of the 4<sup>th</sup> International Partners in Flight Conference (eds. T.D. Rich, C. Arizendi, D. Demarest, and C. Thompson). Pp. 1-11.
- Patterson, J.W. 2012. Evaluation of new obstruction lighting techniques to reduce avian fatalities. Technical Note: DOT/FAA/TC-TN12/9.
- Sheppard, C. 2015. Bird-friendly Building Design. American Bird Conservancy, The Plains, VA.
- U.S. Green Building Council. 2011. LEED Pilot Credit 55: Bird Collision Deterrence.



# APPENDIX A. Examples of lighting fixtures.

## Examples of Acceptable / Unacceptable Lighting Fixtures

### Unacceptable / Discouraged

Fixtures that produce glare and light trespass

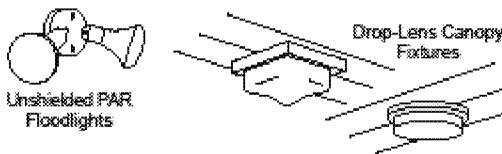
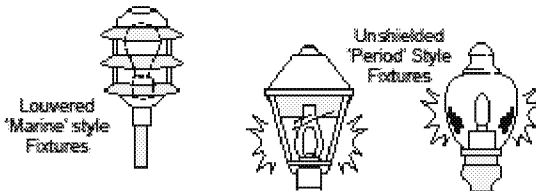
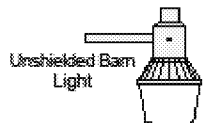
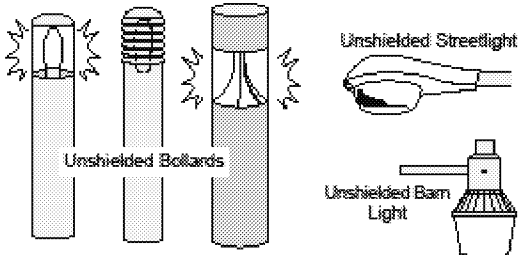
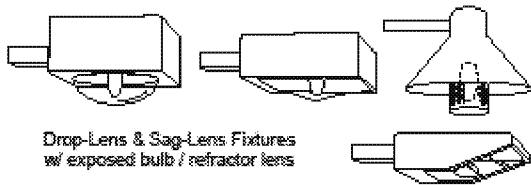
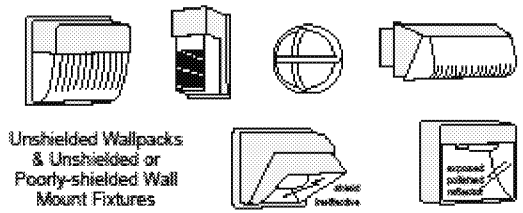
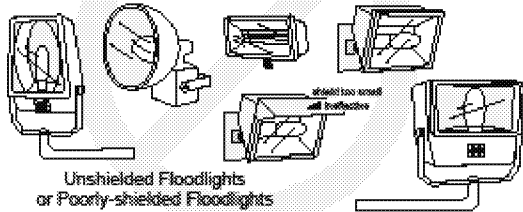

### Acceptable

Fixtures that shield the light source to minimize glare and light trespass and to facilitate better vision at night

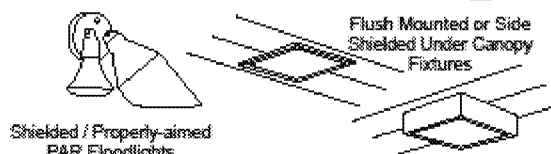
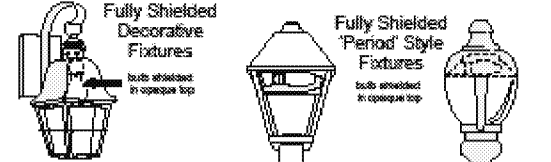
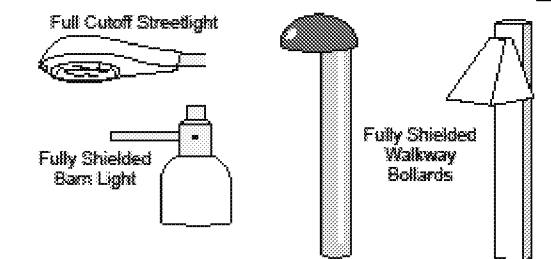
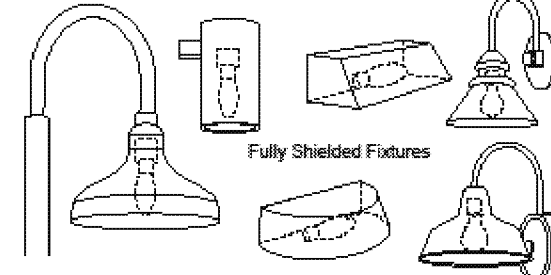
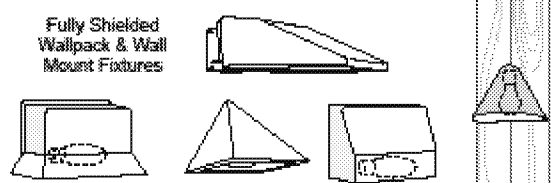
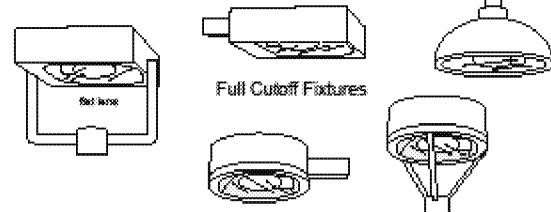

Revised for the Town of East Hampton, NY by Bob Cribb ©2005

## **Record of Document Revisions**

**3/16/16** – Removed the following sentence from page 11, #3: “If your feeders cannot be placed within 3 feet of a window, they should be placed at least 30 feet away.” The latest science indicates that distances greater than 30 feet may not be beneficial; and, in fact, may be detrimental.

**7/27/16** – Corrected typos and clarified instruction on pages 10 and 13 regarding what to do with dead or injured birds that are discovered.