

PROJECT: TYPE: CATALOG NUMBER: SOURCES: NOTES:

CATALOG NUMBER LOGIC

Example: Material: Series: Source: LED Type: Optics: Finish:

Table with columns for Powder Coat Color, Satin, Visible, Machined, etc.

Lens Type: Shielding: Cap Style: Option: 360 SL™ Rotational (Infinite) Mounting System

B-K LIGHTING 40420 Blvdwood Drive • Marina, CA 90251 • USA

HOLLYWOOD PARK RESIDENTIAL | LOS ANGELES, CA 12 MAR 2018 LIGHTING CATALOG PAGE TYPE AL1, AS1 1 of 24

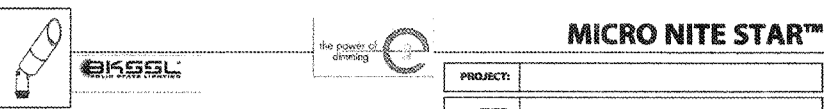

PROJECT: TYPE: CATALOG NUMBER: SOURCES: NOTES:

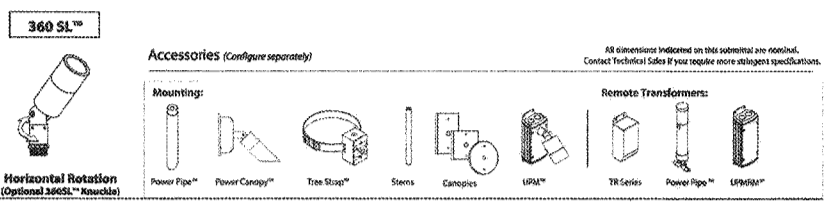
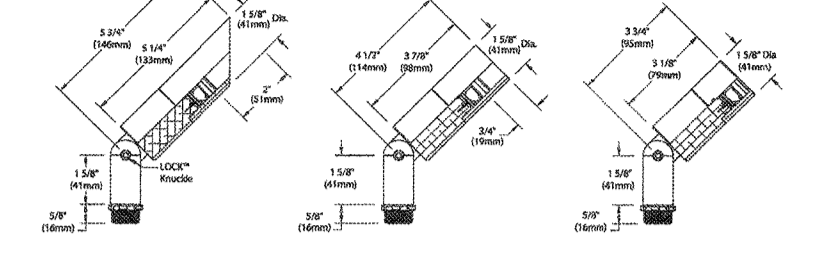

Specifications: GreenSource hollow™: Materials: Body: Lens: Cap: Optics: Remote Transformer: Wiring: Hardware: Finish: Warranty: Certification and Listing:

B-K LIGHTING 40420 Blvdwood Drive • Marina, CA 90251 • USA

HOLLYWOOD PARK RESIDENTIAL | LOS ANGELES, CA 12 MAR 2018 LIGHTING CATALOG PAGE TYPE AL1, AS1 2 of 24



PROJECT: TYPE: CATALOG NUMBER: SOURCES: NOTES:

DRIVER DATA table with columns: Input Volts, Inrush Current, Operating, Dimmable, Operation Ambient Temperature

LM79 DATA table with columns: BK No., CCT, CRI, Input Watts, Minimum Rated Life, 70% of Initial Lumens

OPTICAL DATA table with columns: Angle, CIRC, Delivered Lumens

B-K LIGHTING 40420 Blvdwood Drive • Marina, CA 90251 • USA

HOLLYWOOD PARK RESIDENTIAL | LOS ANGELES, CA 12 MAR 2018 LIGHTING CATALOG PAGE TYPE AL1, AS1 3 of 24



TYPE: SPECIFICATIONS:

CONSTRUCTION: FIXTURE: FLEX ARM: MOUNT: FINISH: SWITCH: LENS: C-RING: 12V ELECTRICAL SPECIFICATIONS: LAMP SUPPLIED: LAMP OPTIONS: SOCKET: WIRING: 120V ELECTRICAL SPECIFICATIONS: LAMP SUPPLIED: LAMP OPTIONS: SOCKET: WIRING:

ORDERING INFORMATION table with columns: CATALOG NO., DESCRIPTION, LAMP, SHIP WEIGHT

JOB INFORMATION form with fields: Job Name, Date, Job No., Location, etc.

B-K LIGHTING 40420 Blvdwood Drive • Marina, CA 90251 • USA

HOLLYWOOD PARK RESIDENTIAL | LOS ANGELES, CA 12 MAR 2018 LIGHTING CATALOG PAGE TYPE AS2 4 of 24



TYPE: SPECIFICATIONS:

Post construction: Lamp enclosure: Electrical: Finish: Anchor base: Luminaire Lumens: Tested in accordance with LM-79-08

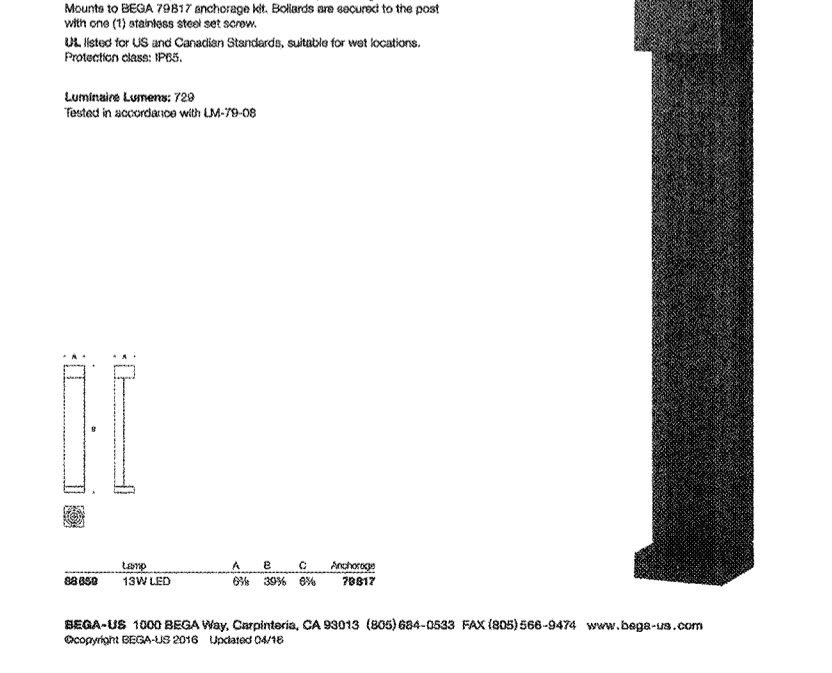

B-K LIGHTING 40420 Blvdwood Drive • Marina, CA 90251 • USA

HOLLYWOOD PARK RESIDENTIAL | LOS ANGELES, CA 12 MAR 2018 LIGHTING CATALOG PAGE TYPE BH1 5 of 24



TYPE: SPECIFICATIONS:

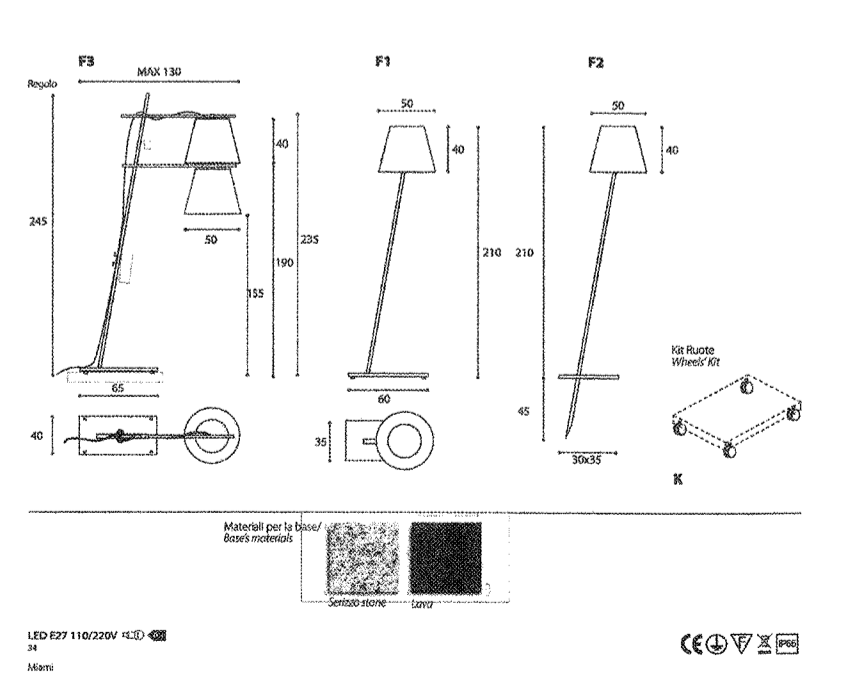
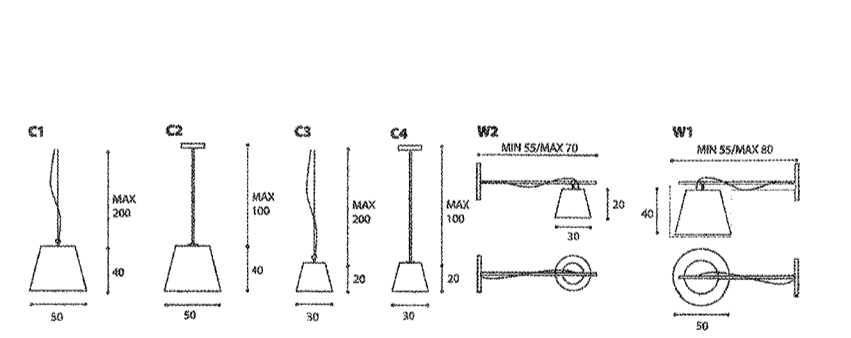

B-K LIGHTING 40420 Blvdwood Drive • Marina, CA 90251 • USA

HOLLYWOOD PARK RESIDENTIAL | LOS ANGELES, CA 12 MAR 2018 LIGHTING CATALOG PAGE TYPE DF1 6 of 24

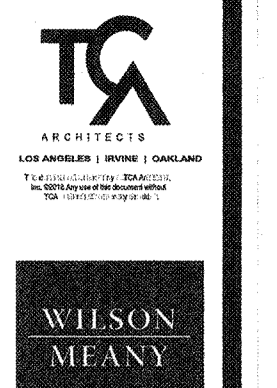

Table with columns: No., Description, Qty., Unit, Price, Total

HOLLYWOOD PARK RESIDENTIAL - MU-10 INGLEDWOOD, CALIFORNIA LIGHTING CUT SHEETS - 01 NOT FOR CONSTRUCTION LD0.11 2017-083 JOB NUMBER 08-21-2018