

City of Inglewood

Proposed Well No. 8

Preliminary Design Report

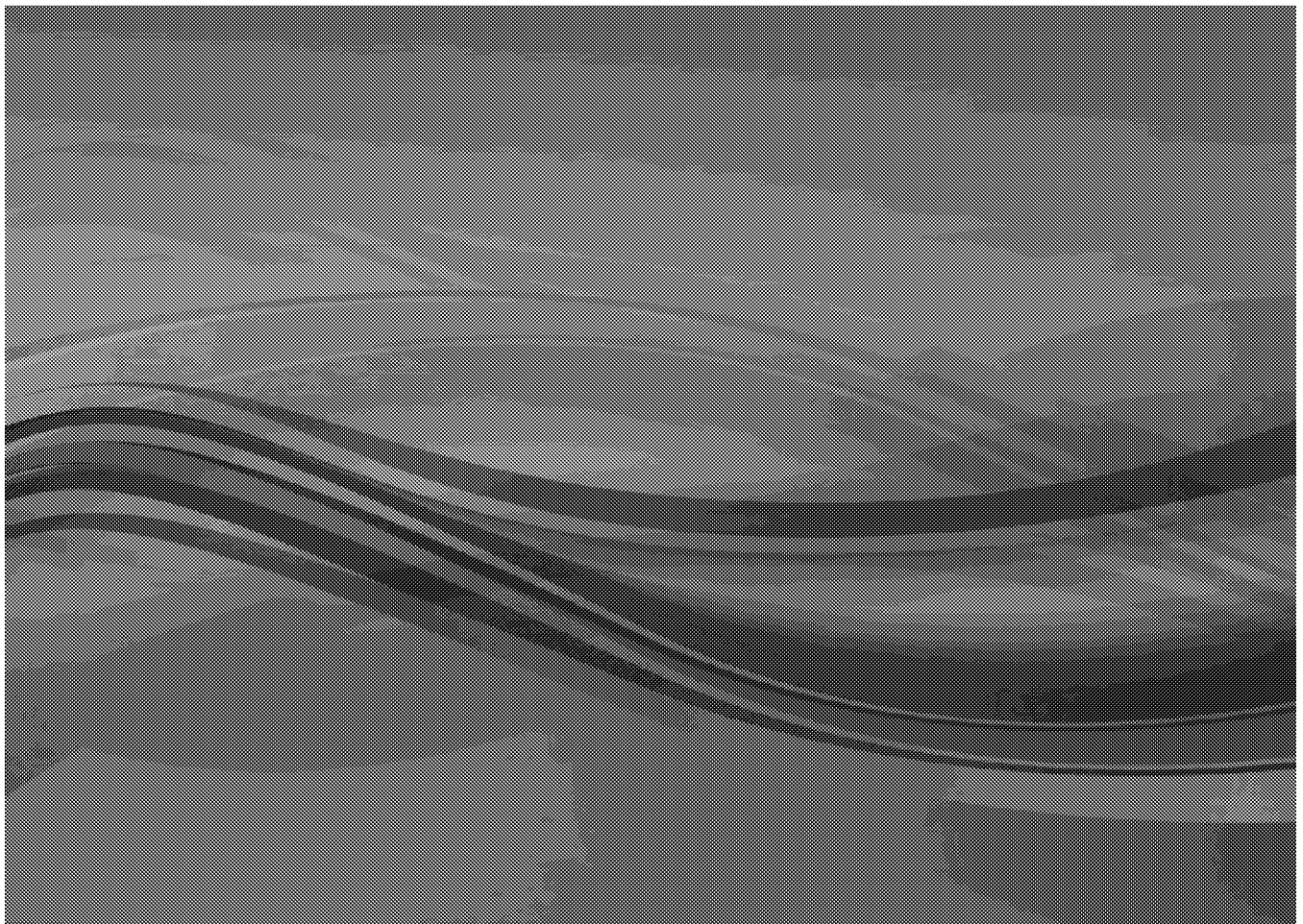

July 2018

Proposed Well No. 8 Preliminary Design Report

July 2018

PREPARED FOR

Murphy's Bowl LLC

10400 NE 4th Street Suite 3000
Bellevue, WA 98004

PREPARED BY

Tetra Tech

160 Via Verde, Suite 240
San Dimas, CA 91773

Phone: 909-305-2930:
tetratech.com

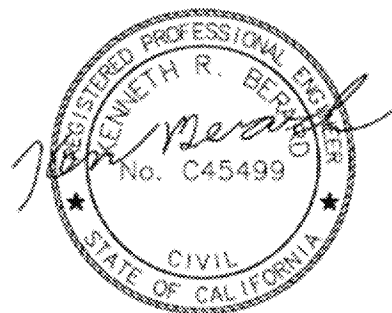

Tetra Tech Project #200-202670-18001

CONTENTS

Introduction.....	1
Existing Well No. 6 Conditions.....	1
Proposed Well No. 8 Site.....	1
Hydrogeologist Report.....	3
Equipping.....	4
Other.....	6
Permitting and Approvals.....	6
Existing Well No. 6 Destruction	6
Engineer's Estimate.....	9

Tables

Table 1. Potable Well Distance Guidelines.....	2
Table 2. Estimated Existing Pavement Restoration Requirements.....	3
Table 3. Preliminary Well-8 Development Design Parameters.....	5
Table 4. Estimate Design Fees and Costs Summary	10

Figures

- Figure 1 - Site Plan
- Figure 2 - Mechanical Plan and Sections
- Figure 3 - DDW Exhibit

Appendices

- Hydrogeology Report
- Well No. 6 Record Drawing WS741

INTRODUCTION

There are current considerations to develop the area around the City of Inglewood Well No. 6 which would require destruction of that well and construction of a replacement well. The City refers to this potential replacement well as Well No. 8.

This Preliminary Design report assesses the feasibility and requirements for the destruction of Well No. 6, and the construction of Well No. 8 at a City lot located approximately 500' from Well No. 6 and near the intersection of 102nd St. and Doty Ave. Specifically, this report includes a preliminary assessment of the well drilling, well equipping, and site improvements including an estimate of construction costs.

EXISTING WELL NO. 6 CONDITIONS

The City of Inglewood's Well-6 was constructed in 2003 and has experienced declining pumping capacity and specific capacity over the years.

The well consists of a Flowserve constant speed 200 HP vertical turbine pump set approximately 400-feet below grade. The well includes approximately 180-feet of screen and 550 feet of 20-inch blank casing. Initial pumping tests were at flows of 1,500 to 4,400 gpm and the original recommended flow rate for Well-6 was 2,800 gpm. The pump was replaced in 2011 with a reduced flow of 1,400 gpm. However, water quality issues have reduced the average day use to approximately 1,200 gpm.

Well-6 had been scheduled for rehabilitation to increase its capacity to 1,500 gpm in 2017. The proposed rehabilitation work is designed to seal off holes in the casing and cleaning perforations. Also, the rehabilitation work will provide additional perforations in the well casing located in the lower aquifer (440 – 510 feet below grade), which has better water quality, with the goal to increase the overall flow capacity from Well-6. However, this work has been delayed due to potential relocation of the well.

PROPOSED WELL NO. 8 SITE

Well Location

The City of Inglewood has identified Lot 35, located near the intersection of Doty Ave and 102nd Street, as the proposed location for Well No. 8. This lot is divided into two sublots (both owned by the City) and we have assumed that both lots can be utilized for Well No. 8 facilities. Refer to Figure-1 "Well No. 8 Site Plan" and Figure-2 "Well No. 8 Mechanical Plan and Sections" for illustrations of the proposed site location and well equipment. Piping and pump sizes illustrated are based on the hydrogeologist recommendations (discussed later this PDR) and may change dependent on the final testing results on the drilled well.

The State Water Resource Control Board's Department of Drinking Water (DDW) sets guidelines for well separation distances to certain utilities.

The following table shows the DDW guidelines and the actual distances from the proposed well location in the PDR to the utilities:

Table-1: Potable Well Distance Guidelines

DDW GUIDELINES FOR SEPARATION FROM POTABLE PIPING		
Utility	DDW Guideline	Actual Distance
Any sewer line (sanitary, industrial, or storm: main or lateral)	50 feet	179 feet (SS) 193 feet (SD) >300 feet (MH)
Watertight septic tank or subsurface leaching field	100 feet	NA
Cesspool or seepage pit	150 feet	NA
Recycled water use area	50 to 100 feet*	NA
Animal or fowl enclosure	100 feet	NA

* Depending on level of treatment of recycled water

In addition, there is a 50-foot Control Zone requirement. The 50-foot Control Zone refers to an area that is necessary to have some assurance that potentially detrimental land uses will not be introduced in the future. For example, that a third party would not construct a sewer line within 50 feet of the well.

The highest level of control would be if the 50-foot control zone was entirely within our project property. If this is the case, DDW generally would not take issue with the control zone. Our proposed well location is on the longitude north-south centerline of Lot 35, a City of Inglewood owned property, and provides 50 feet of separation from the both the eastern and western limits of the lot. The proposed well location is 260 feet south of the northern property line of Lot 35, and 50 feet north of the southernmost limit of the lot. Figure-3 “Well No. 8 DDW Exhibit” illustrates the proposed well location and its approximate distances to vicinity sanitary and storm sewers and 50-ft Control Zone for use in future discussions with DDW, if required.

Currently Lot 35 is unimproved, rough graded level, with native grasses. Properties to the east and south are residential homes, the property immediately to the west (Lot 34) is commercial.

DDW has issued approval on previous similar projects and has sometimes added additional well design requirements, such as a deeper well sanitary seal. Of course, the formal permitting process will need to be completed to obtain DDW approval and identification of any mitigation measures.

The location of the well was also determined based on logistical constraints during well drilling and future well maintenance. The site was evaluated to assure adequate space for drilling equipment during well construction and equipping.

Site Access and Security

A 15-ft wide driveway is proposed adjacent to the western side of the proposed well location and wraps around to the south of the electrical control cabinet in order permit maintenance vehicles to turn around. Areas outside the pavement will be furnished with crushed stone, and therefore larger vehicles will be able to access the well, if needed.

A six-foot-tall concrete masonry unit (CMU) security fence is proposed to enclose the project site and includes an automated sliding access gate along its northern fence line. Fencing the entire of perimeter of Lot 35 is assumed to be unnecessary. Anti-climb accessories (spikes/barbed-wire/razor-wire) for the fencing are not proposed, see Appendix Figure-1.

Two security cameras will be provided. One camera will monitor the pumping equipment, and the other camera stationed on the property access gate. Video will be provided to the City of Inglewood via the pump station telemetry system.

Landscaping

Currently the site contains no trees or landscaping and consists of level terrain with a turf of native grasses. The project proposes to use 1-inch minus crushed stone on interior fenced areas along the access driveway. The finished grading of the site will direct all rainfall precipitation flow to the project on-site catch basin for the waste line.

No landscaping or irrigation systems are assumed for the interior project site.

Landscaped areas along the sidewalk of 102nd Street disturbed by the project work will be restored in kind.

Curbing and Sidewalk

Curbing and sidewalk areas disturbed by the project construction will be replaced in kind and is anticipated to be less than 100 feet, see Figure-1. Curbing in front of the proposed access drive will be modified with a gentle slope to meet the elevation of 102nd Street.

Street Improvements

Pavement restoration on 102nd Street will be required for the trenched installation of the Well-8 discharge piping, waste line, and relocated water main. Table-1 below lists the three restoration areas and approximate lengths of restoration.

Table-2: Estimated Existing Pavement Restoration Requirements/Proposed Means

PAVEMENT RESTORATION REQUIREMENTS/PROPOSED MEANS		
<u>LOCATION</u>	<u>ESTIMATED LENGTH</u>	<u>PAVEMENT RESTORATION</u>
Discharge Piping	30 Feet	Tee Patch
Waste Line Piping	115 Feet	Tee Patch
Relocated Water Main	150 Feet	Tee Patch

Tee patching of the trenched lines is planned for the pavement restoration and no full lane pavement replacements are proposed. Restriping of the pavement will be restored where destroyed.

Low Impact Development

The proposed improvements to the Well No. 8 are not required to comply with the Low Impact Development (LID) improvements as identified in the City’s municipal code Section 10-208, since the site is less than 1 acre and since the area of the proposed impervious improvements is less than 5,000 square feet. (The existing site is 0.75-acres and proposed impervious improvements are approximately 3,000 square feet.) However, the project does comply with the spirit of LID by reducing impervious areas and increasing pervious areas as much as practical. The impervious site improvements will be a new 15-ft wide paved access road leading to a small paved area around the well equipping. The majority of the lot will remain unpaved and pervious, allowing the majority of onsite storm water to percolate to groundwater.

Electrical Power

Power will be provided by Southern California Edison (SCE). An existing utility pole located 50 feet east of the site on south r/w of 102nd Street is expected to be the connection location to provide the power for the new Well-8 facility. Because this report is preliminary, the power requirements are unknown and therefore the availability of power from SCE on this utility pole cannot be confirmed at this time. It is recommended to contact SCE early in the design phase that follows this PDR in that coordinating the power hook up can be a long lead time of 6 months or more.

Noise

Submersible pumps are proposed to minimize noise impacts to the adjoining residential property owners. Because the pump motor will be inside the well itself (below grade) very little operational noise is expected from Well-8.

Portions of the drilling operations of the well will operate on a 24-hour basis at times. To reduce the impacts on the adjacent residential properties the drilling contractor will be required to install temporary sound attenuating walls.

Water Quality

The water quality of the proposed well will be evaluated with laboratory testing during the drilling operations phase of the project. The hydrogeological report concludes the proposed Well-8 site is hydrogeologically feasible. However, it should be noted that water quality issues regarding elevated TDS, Fe, Mn or other problematic constituents could be present in the final wellblend sample from the well.

Because groundwater at the proposed well site may have elevated concentrations of Fe and/or Mn and potentially TDS, isolated aquifer zone testing will be conducted to aid to check for the presence of these constituents. Zone testing will include analysis for other parameters including VOCs and perchlorate, which have been documented to occur in prior, shallow, monitoring wells at the former Hollywood Park Racetrack.

Water from the proposed Well-8 is intended for use at the City of Inglewood's Sanford Water Treatment Plant, which has some capacity to accept and treat some levels of the water quality constituents discussed. Also, onsite treatment systems may be capable of pretreating the proposed Well-8 water prior to its discharge into the city's 27-inch water main on 102nd Street, but is dependent the specific constituent and concentration level. It should be noted that development of a well presents many variables in respect to water quality constituents that cannot be known until field work is performed and provides laboratory samples for testing. The suitability of the proposed site for Well-8 will require verification by the laboratory analysis of the water samples collected from the site.

However, the hydrogeological report indicates the water quality at the proposed Well-8 site will likely to be similar to the nearby existing Well-6, which does not require onsite treatment systems and is in current use by the city's water treatment facility. Therefore, options and costs presented in this report assume that onsite treatment systems at the proposed Well-8 site to reduce/remove water quality constituents will not be required.

Existing Raw Water Main Connection

The Well-8 discharge piping will connect to the existing City of Inglewood raw water main, located immediately in front of the proposed site on 102nd Street. The preliminary design will assume a connection point pressure in the existing raw water main of 40 psi.

HYDROGEOLOGIST REPORT

A final hydrogeological report was prepared by Richard C. Slade on March 2018, see Appendix-D. The report estimates the potential well capacity to be up to 2,500 gpm. A conservative flowrate of 2,000 gpm will used for the

preliminary design and will be updated (if necessary) when testing results provide more refined data on the Well-8 capacity.

Additional Well-8 preliminary development design parameters are summarized in Table-3 on the next page.

Table-3: Preliminary Well-8 Development Design Parameters

PELIMINARY WELL-8 DESIGN PARAMETERS	
Pilot Borehole Depth	750 ft bgs*
Preliminary Cased Depth	720 ft bds*
Casing Diameter	20-inches*
Casing Material	Type 304L Stainless Steel*
Casing Size	20-inches*
Current Static Water Level	130 ft bgs*
Specific Capacities	30 to 40 gpm/ft ddn*
Potential Water Quality Constituents of Concern	TDS, Fe, Mn, and perchlorate**
Preliminary Drilling, Development, Testing, Equipping, and Destruction of Well 6 Costs Estimate	\$2.6M to \$2.9M*
*Final depth, design, costs to be determined (see Appendix: RC Slade Report)	
**Water quality to be evaluated during pilot bore hole operations.	

EQUIPPING

Preliminary equipment selection and sizing is described below.

Submersible Pump

A submersible pump is recommended for Well-8 to reduce noise to nearby residences. The pump bowl diameter should be sized to perform within the 20-inch inside diameter casing. The pump bowl diameter should be sized to provide maximum velocity of 10 ft./sec across the motor in order to prevent excessive wear on pump, motor, and casing. This translates to a maximum pump bowl diameter of approximately 17.5 inches.

A minimum velocity should also be considered to provide adequate circulating water across the submersible motor for cooling. The pump bowl diameter should be sized to provide a minimum velocity of 0.5 ft./sec across the motor for cooling. A low velocity scenario should be considered when pumping at low capacity of 200 gpm over an extended period. Under this scenario, the minimum pump bowl diameter should be 15 inches.

Discharge Piping and Control

The Well 8 piping configuration will be the similar as the City of Inglewood’s plans for Well 7. This includes a Pump Control Valve with Check feature on the discharge line and a solenoid controlled valve on the waste line.

Well start-up will follow the procedure below:

1. Both the pump control valve and the solenoid valve will be closed when the well pump is off.

2. When an 'on' signal is received, the solenoid valve will begin to open and then the pump will begin to ramp up with a variable frequency drive (VFD) increasing the pump speed. This allows 'first flush' of the well water to be sent to waste.
3. The solenoid valve will then begin to slowly close and the pump control valve will begin to open. The closing/opening of the two valves will be synchronized via a pressure sensing line connecting the two valves.
4. The solenoid valve will completely close and the pump control valve will completely open, and the pump VFD will then run at the set speed.

A surge analysis was not performed as part of this report and no surge protection system is included in this proposed preliminary design.

Pump Control

A variable frequency drive will be included to allow well discharge adjustments in response to water demands, to aquifer changes, and to provide long term power savings. For example, a VFD will allow less water to be pumped to the conveyance piping system when water demands are lower. Changes in water quality may also benefit by adjusting the flow as this will give some control of the combined water quality in the raw water transmission mission main, which is a blended composition of water from multiple well sources. Due to the length of power cable required between the VFD and the submersible pump, a filter will be required to limit high frequency noise.

Buildings/Shelters

The City of Inglewood well facilities typically do not include buildings/shelters for the pumping equipment. No buildings or shelters are proposed for the Well 8 design.

VFD Cooling

Typically, a VFD drive is rated to operate under 40 degree Celsius, or about 104-degree Fahrenheit. Sources of heat impacting the VFD include heat generated from the VFD itself, ambient temperature, and solar heating from sunlight.

Based on NOAA data at the nearby Torrance and Hawthorne airports, ambient temperatures near the City of Inglewood can reach around 100 degrees, and occasionally may peak above 100 degrees Fahrenheit for short periods during the summer. Therefore, some cooling of the VFD will be required.

There are several methods that are sometimes used separately or in combination to cool VFD's, including:

1. Using a "De-rated" VFD that is larger than required. For example, using a 350 HP VFD instead of a 300 HP. A 350 HP would generate less heat when running a pump that only requires 300 HP.
2. Add air vented heat sinks to the VFD.
3. Put the VFD cabinet in another cabinet, and then supply air conditioning to cool the space between the two cabinets.
4. Put a shade structure or enclosure around the VFD cabinet to shield it from sunlight.

After considering cost and future maintenance required for the different VFD cooling options, we recommend using a larger cabinet with air conditioning system to keep the VFD running under the rated temperature. Based on our research from various manufacturers, a 300 HP VFD with the air conditioning unit will cost about \$75,000 (material only). In addition, a small shade structure should be added to the cabinet to shade the cabinet during the hottest

parts of the day. Due to the high ambient temperatures, it is difficult to maintain low enough temperatures through methods other than air conditioning.

Emergency Power

No permanent on-site back-up power source (generator) will be provided for the Well 8 pumping system. The electrical design will include the required connections to use a trailer mounted portable generator at Well 8.

Lighting

No lighting of the project site is proposed.

OTHER

Waste Line Discharge

The nearest storm drain system to the well site is a LA County Flood Control District catch basin (located at the southwest corner of 102nd Street and Doty Ave) that is connected to an 84" storm drain (located in the eastern r/w of Doty Ave). A gravity well drain line will need to be constructed from the site east to the LACFCD storm catch basin. Record information obtained during the detail design phase will confirm that a sufficient gradient exists between the air-gap catch basin and the proposed discharge point at the LACFCD catch basin. Because the receiving storm drain from the LACFCD catch basin is a large diameter, gravity flow is not expected to be an issue.

Because the waste discharge line will require gravity flow, we are including the relocation of a short section of the existing 6-inch water main (see Figure-1) to ensure there are no conflicts with its existing elevation. The proposed alignment of the gravity waste line will parallel the relocated 6-inch potable line by more than 5 feet. This alignment maintains adequate clearance from existing utilities and meets DDW separation requirements from potable water lines.

PERMITTING AND APPROVALS

The project will require permitting and/or approvals from various agencies in order to be constructed and operated. The following listing identifies the key agencies to be coordinated with during the subsequent design phase of the project.

- Division of Drinking Water (DDW)
- City of Inglewood Public Works Department
- City of Inglewood Encroachment Permit
- State of California (Application for Well Permit)
- Los Angeles County (Application for Well Permit)
- Los Angeles County Flood Control District
- Los Angeles County Department of Environmental Health (Well-6 destruction)

EXISTING WELL-6 DESTRUCTION

The purpose of the existing Well-6 destruction is to ensure it will no longer act as a conduit for surface water contamination, cross-contamination of water of differing quality into multiple aquifers, and the pressure head in the aquifer is preserved. If vertical movement of water within the well bore, including the annular space, is prevented, then the objective for destruction of the well has been achieved.

Because there is a strong likelihood of future development on the existing Well-6 site after its destruction, the proposed destruction will remove all materials to an elevation of 10 feet below the existing grade to help avoid conflicts. This proposed clearance elevation will require the approval of the DDW, Los Angeles County, and the City of Inglewood.

Predestruction Activities

- Obtain record information on existing Well-6 construction, static water levels/well depths, and maintenance logs, if available.
- Inspect and remove any obstructions from the existing bore (old pumps or debris).
- Perform a video survey of the well to determined casing conditions.
- Remove sediment from bottom of casing.

Well Casing Destruction

Well-6 destruction will involve pulling any existing casing out of the ground as applicable and/or feasible, or perforating or otherwise causing openings to be made in the casing. Openings in casing may be made with a gun-perforator per oilfield practice, an air-percussion perforator, ripped with a mechanical knife or similar device if casing condition allows, or destroyed using explosive devices. In some situations, detonator cord or shaped charges may be placed in the well at selected intervals, and after placement of neat cement sealing material, exploded, thus simultaneously opening the casing and driving the sealing material into the annulus and borehole wall.

Because Well-6 has known casing repair patches there is the potential for a mechanical knife to become irretrievably lodged in the casing and impede the sealing material from reaching the full extents of the casing, therefore the second method of explosive charges is proposed. Shot charges will be placed along the entire length of the existing casing to an elevation of 10 feet below grade.

The purpose of these operations is to facilitate entry of sealing material into the annulus and achieve penetration into the native formation or any existing gravel pack to the maximum extent possible.

Sealing Materials

Neat cement grout will be used for the sealing of Inglewood Well-6. Neat cement grout generally involves using a ratio of one 94-lb bag of Portland cement to no more than 6-1/2 gallons of water (which is equal to a 17-sack cement/water mix as available from a “ready-mix” source). A small amount of bentonite (up to 6 percent) may be added to make the mixture more “fluid” and reduce shrinkage.

Sealing Materials Placement

The sealing materials will be placed from the bottom of the well up, using a tremie pipe which is kept submerged in the mixture and is periodically raised as the well bore is filled in one continuous operation. The sealing method will also determine the volume of the hole to be filled, and compare to the volume of sealing materials used, to be sure that the volume of materials emplaced is at least equal to the hole volume.

Once the sealing materials have been placed the shot charges will be detonated. It should be noted that the nearest residences to the site are approximately 250 ft to the northeast. The hydrogeological report indicates the shockwaves generated by the detonation of the charges will likely undergo significant attenuation and thus are not likely to impact those residences.

The bore hole will be sealed to 10-ft below existing grade to aid in reducing conflicts with any future development on the site, pending approvals, as previously discussed. After the cement has cured, the casing will be excavated to

remove approximate 6-ft of the casing and the construction of a “mushroom cap” composed of concrete with rebar reinforcement.

The excavations will be back-filled with native soils and compacted to 95%. Two inches of crushed stone (1-inch minus) will be placed over the compacted excavated areas to match the existing grounds cover.

Destruction Completion Notifications

The Contractor will complete and file the well destruction forms with the Los Angeles Department of Environmental Health and DWR as notification of completion and to provide final destruction documentation.

Preliminary Well-6 Borehole Destruction and Sealing Costs:

The preliminary Contractor costs for the destruction of the existing Well-6 is estimated to range from approximately \$60,000 to \$90,000 for destruction and sealing work.

Destruction/Disconnect of Existing Utilities

Record drawing WS-741 from 2003 illustrates the general layout for Well-6 and is included in the appendix of this report. The extents of existing facilities to be destroyed includes the following items:

- *Waste Water Disposal System:* The system consists of above and below grade 12-inch piping (approximately 50 LF) which transfers the waste water to a 12-ft diameter HDPE holding tank located on a 16-ft x 16-ft concrete support slab. From the holding tank the waste water flows by gravity through a below grade 6-inch line (approximately 140 LF) connected to an 8-inch gravity sanitary sewer located on the centerline of 102nd Street.
 - a. Destruction will include removal of all above and below grade waste water piping, the holding and its concrete support slab, disconnection from the sanitary sewer and concrete encasement of the disconnection point on sewer line.
- *Raw Water Discharge Line:* The existing Well-6 includes an 18-inch discharge line (approximately 120 LF) connected to a 27-inch raw water transmission main on 102nd Street.
 - a. The connection at the 27-inch raw water main will be severed at the gate located connection point. A blind flange will be installed on the gate valve, and entirely concrete encased. All 18-inch discharge piping will be removed from the site.
- *Above Grade Piping/Appurtenances:*
 - a. All above grade piping, valves, pump motor/mount, and appurtenances will be removed from form the site.
- *Electrical/MCC:* The facility contains a small MCC (approximately footprint 30-inches x 72-inches) with underground power conductors to an above grade transformer, located at the southwest corner of the site.
 - a. The MCC and underground conductors will be removed from the site. Conductors will be terminated at the SCE transformer. The SCE transformer will be remain in place.
- *Miscellaneous:*
 - a. The concrete slab (approximately 20 ft x 40 ft) surrounding the above grade piping at the well will be demolished removed from the site.
 - b. Security cameras and telemetry system will be removed from the site.
 - c. The existing concrete access drive will remain in place.
 - d. The site will be level graded and seeded with southern California native grasses.
 - e. The existing security fence will remain in place.

ESTIMATED DESIGN FEES AND COSTS SUMMARY

A summary of estimated design fees and preliminary costs described in this report are shown in Table-4 below.

Table-4: Estimate Design Fees and Costs Summary

ESTIMATED DESIGN FEES AND COSTS SUMMARY		
Well-8 Drilling		Range Estimate
Well-8 Drilling Contractor	\$ 1,000,000	\$ 1,300,000
Engineering and Construction Assistance	\$ 200,000	
Subtotal:	\$ 1,200,000	\$ 1,500,000
Well-8 Equipping		
Well-8 Equipping Contractor	\$ 1,023,000	
Engineering Design & Surveying	\$ 149,000	
Construction Assistance	\$ 50,000	
Subtotal:	\$ 1,222,000	
Well-6 Destructon		Range Estimate
Well-6 Destruction Contractor	\$ 70,000	\$ 90,000
Well-6 Equipment Demolition	\$ 27,000	
Engineering Design	\$ 14,550	\$ 17,550
Subtotal:	\$ 111,550	\$ 134,550
TOTAL:	\$ 2,600,000	\$ 2,900,000

Well-8 construction assistance costs for drilling do not include inspection services, but do include geologist and geohydrologist field time to monitor well drilling operations, and reviewing the field collected information to update well design parameters as needed.

Well-8 construction assistance services for equipping include reviews of contractor shop submittals, requests for information, and design clarifications.

FIGURES

7/23/2018 11:43:48 AM - P:\202670\200-202670-18001\CAD\SHEETFILES\FIG 1 SITE PLAN.DWG - LEE, ADRIAN

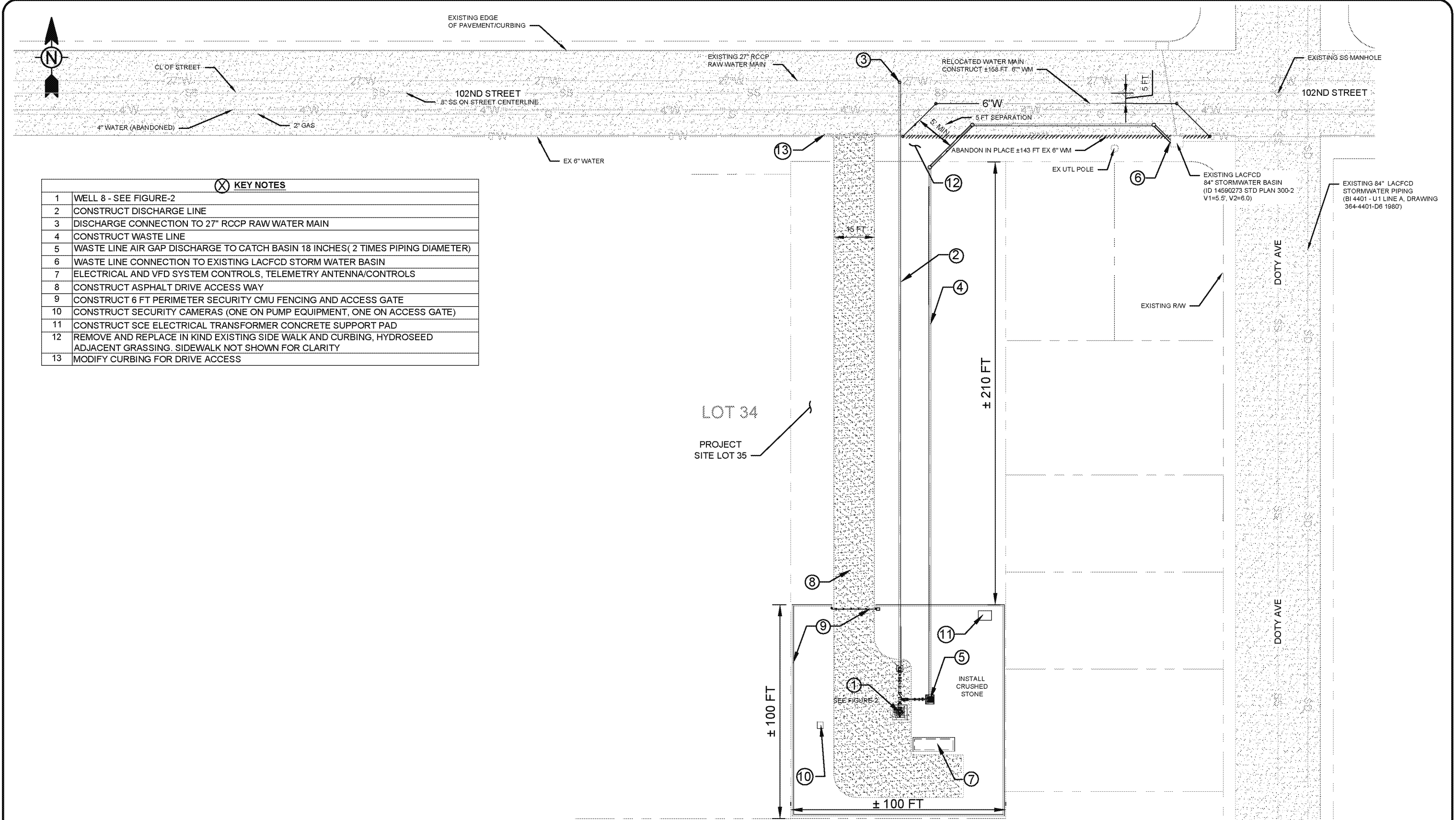

KEY NOTES	
1	WELL 8 - SEE FIGURE-2
2	CONSTRUCT DISCHARGE LINE
3	DISCHARGE CONNECTION TO 27" RCCP RAW WATER MAIN
4	CONSTRUCT WASTE LINE
5	WASTE LINE AIR GAP DISCHARGE TO CATCH BASIN 18 INCHES (2 TIMES PIPING DIAMETER)
6	WASTE LINE CONNECTION TO EXISTING LACFCD STORM WATER BASIN
7	ELECTRICAL AND VFD SYSTEM CONTROLS, TELEMETRY ANTENNA/CONTROLS
8	CONSTRUCT ASPHALT DRIVE ACCESS WAY
9	CONSTRUCT 6 FT PERIMETER SECURITY CMU FENCING AND ACCESS GATE
10	CONSTRUCT SECURITY CAMERAS (ONE ON PUMP EQUIPMENT, ONE ON ACCESS GATE)
11	CONSTRUCT SCE ELECTRICAL TRANSFORMER CONCRETE SUPPORT PAD
12	REMOVE AND REPLACE IN KIND EXISTING SIDE WALK AND CURBING, HYDROSEED ADJACENT GRASSING. SIDEWALK NOT SHOWN FOR CLARITY
13	MODIFY CURBING FOR DRIVE ACCESS

PREPARED FOR
MURPHY'S BOWL, LLC
 10400 BELLEVUE, WA 98004

TETRA TECH
 www.tetratech.com
 160 East Via Verde Ave, Suite 240
 San Dimas, CA 91773
 T: (909) 305-2930 F: (909) 305-2959

City of Inglewood Well 8
CITY OF INGLEWOOD
 WELL NO. 8
 SITE PLAN

Project No.: 200-202670-180001
 Date: Feb 2018
 Designed By: TT
FIGURE 1

Bar Measures 1 inch NOT TO SCALE

Copyright: Tetra Tech

7/17/2018 11:56:28 AM - P:\202670\200-202670-18001\CAD\SHSHEETFILES\FIG 2 MECHANICAL PLAN AND SECTIONS.DWG - LEE, ADRIAN

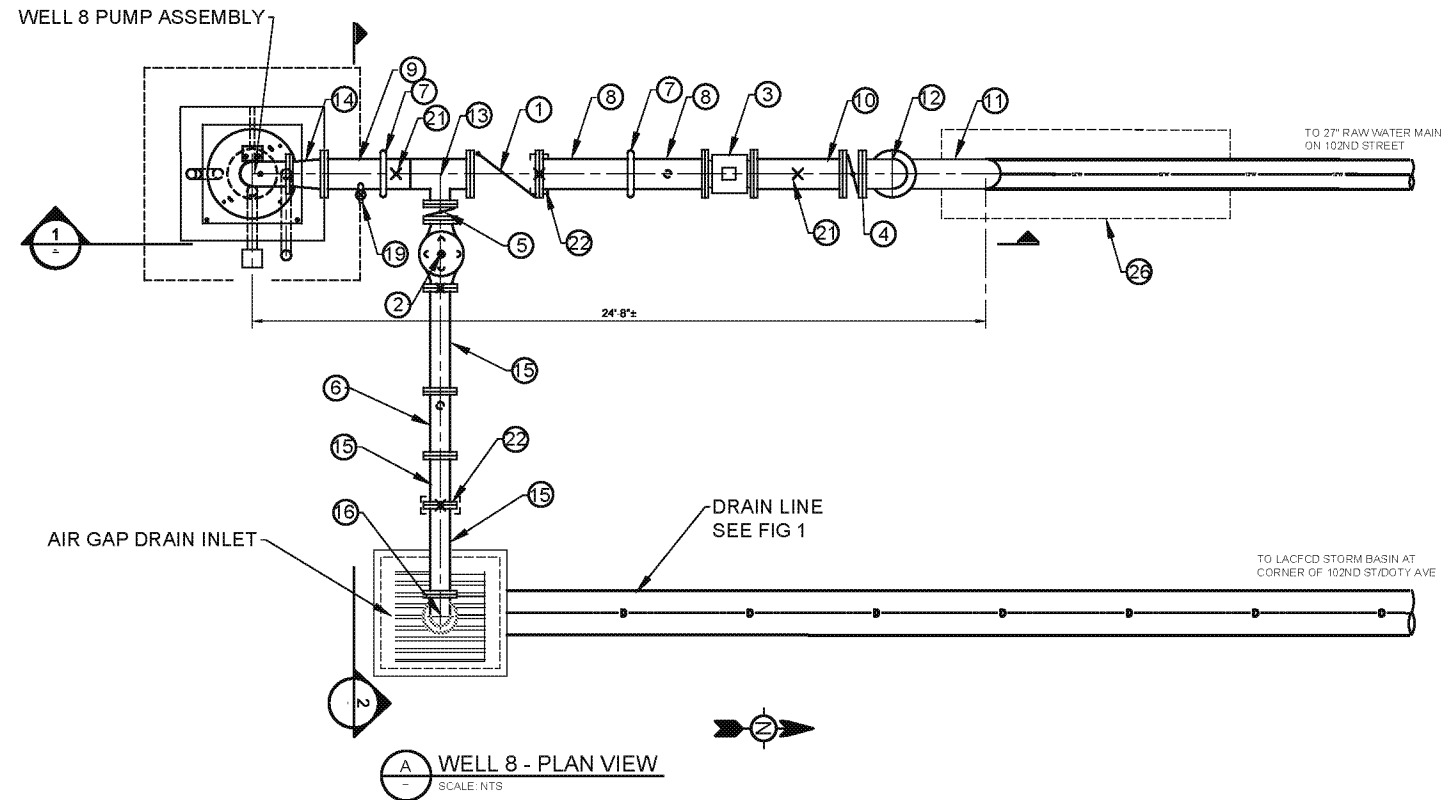

WELL 8 - PLAN VIEW
SCALE: NTS

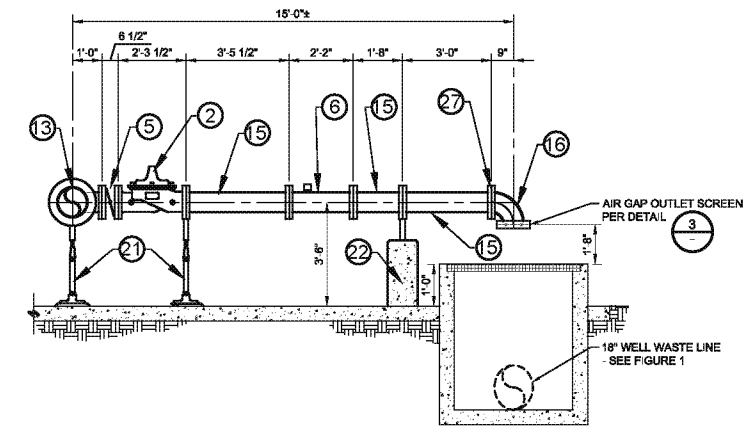

WELL 8 - SECTION
SCALE: NTS

CONSTRUCTION NOTES

- 1 12" SWING CHECK VALVE
- 2 8" SOLENOID CONTROL VALVE
- 3 12" MAGNETIC FLOW METER
- 4 12" BUTTERFLY VALVE
- 5 9" BUTTERFLY VALVE
- 6 8" V-CONE WATER METER
- 7 12" GROOVED END COUPLING
- 8 12" FLGxGE STEEL SPOOL (STD WT), CML AND PAINTED
- 9 12" PEAGE STEEL SPOOL (STD WT), CML AND PAINTED
- 10 12" STEEL PIPE (STD WT), CML AND PAINTED
- 11 12" STEEL PIPE (STD WT), CML AND CMC
- 12 12" 45-DEG STEEL BEND (STD WT), CML AND PAINTED
- 13 12"x8" FLGxPE STEEL TEE (STD WT), CML AND PAINTED
- 14 12"x10" STEEL ECCENTRIC REDUCER (STD WT), CML AND PAINTED
- 15 8" FLGxFLG STEEL PIPE (STD WT), EPOXY LINED AND PAINTED
- 16 8" FLGxFLG 90-DEG STEEL BEND (STD WT), EPOXY LINED AND PAINTED
- 17 2" COMBINATION AIR / VACUUM RELEASE VALVE
- 18 PRESSURE SWITCH AND GAUGE
- 19 SAMPLE TAP
- 20 WASHDOWN CONNECTION
- 21 ADJUSTABLE PIPE SUPPORT
- 22 CONCRETE PIPE SUPPORT
- 23 PRESSURE TRANSMITTER AND GAUGE
- 24 NOT USED
- 25 NOT USED
- 26 CONCRETE ENCASUREMENT
- 27 10" ORIFICE PLATE SEE SPECIFICATIONS

NOTE:

1. ALL ENDS ARE FLANGED, CLASS 125 OR CLASS 150 UNLESS NOTED OTHERWISE.
2. ALL STEEL PIPE SHALL BE STANDARD WEIGHT UNLESS NOTED OTHERWISE.

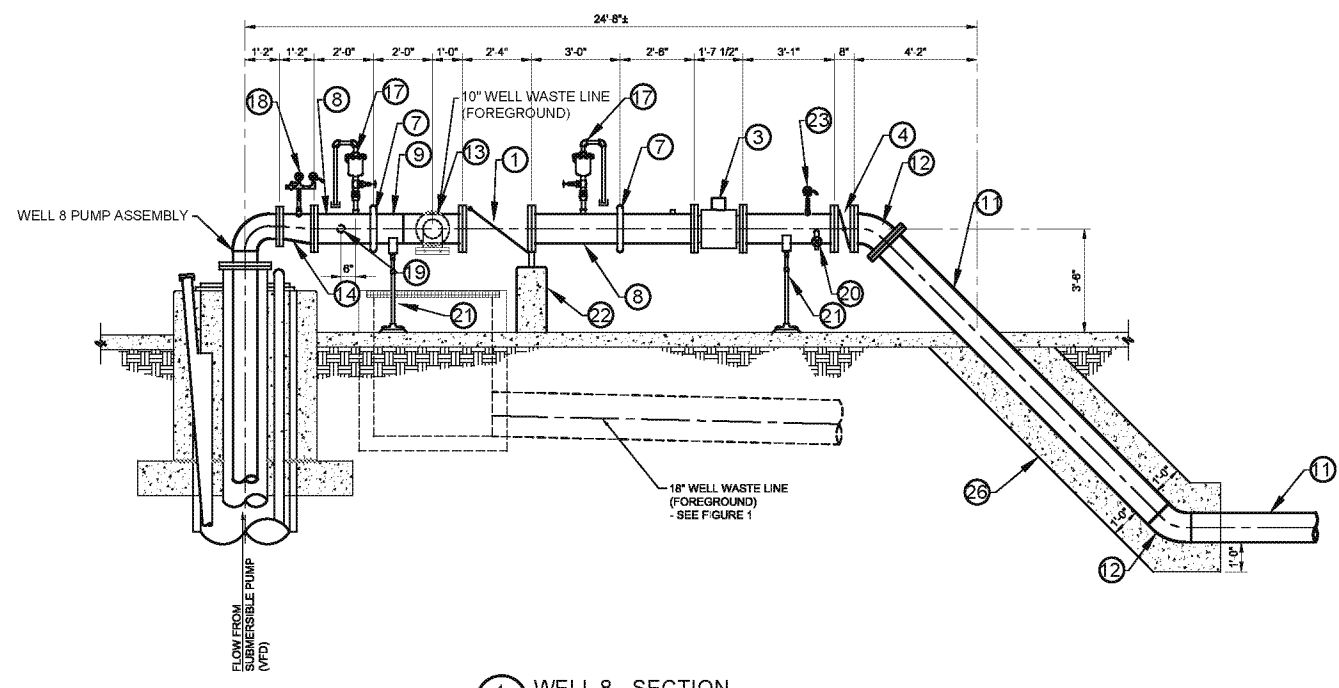

WELL 8 - SECTION
SCALE: NTS

PREPARED FOR
MURPHY'S BOWL, LLC
10400 BELLEVUE, WA 98004

TETRA TECH
www.tetrattech.com
160 East Via Verde Ave, Suite 240
San Dimas, CA 91773
T: (909) 305-2930 F: (909) 305-2959

City of Inglewood Well 8
**CITY OF INGLEWOOD
WELL NO. 8
MECHANICAL PLAN AND SECTIONS**

Project No.: 200-202670-180001
Date: Feb 2018
Designed By: TT
Figure
FIGURE 2

Bar Measures 1 inch
NOT TO SCALE

Copyright: Tetra Tech

7/23/2018 11:33:58 AM - P:\202670\200-202670-18001\CAD\SHEETFILES\FIG 3 DDW EXHIBIT.DWG - LEE, ADRIAN

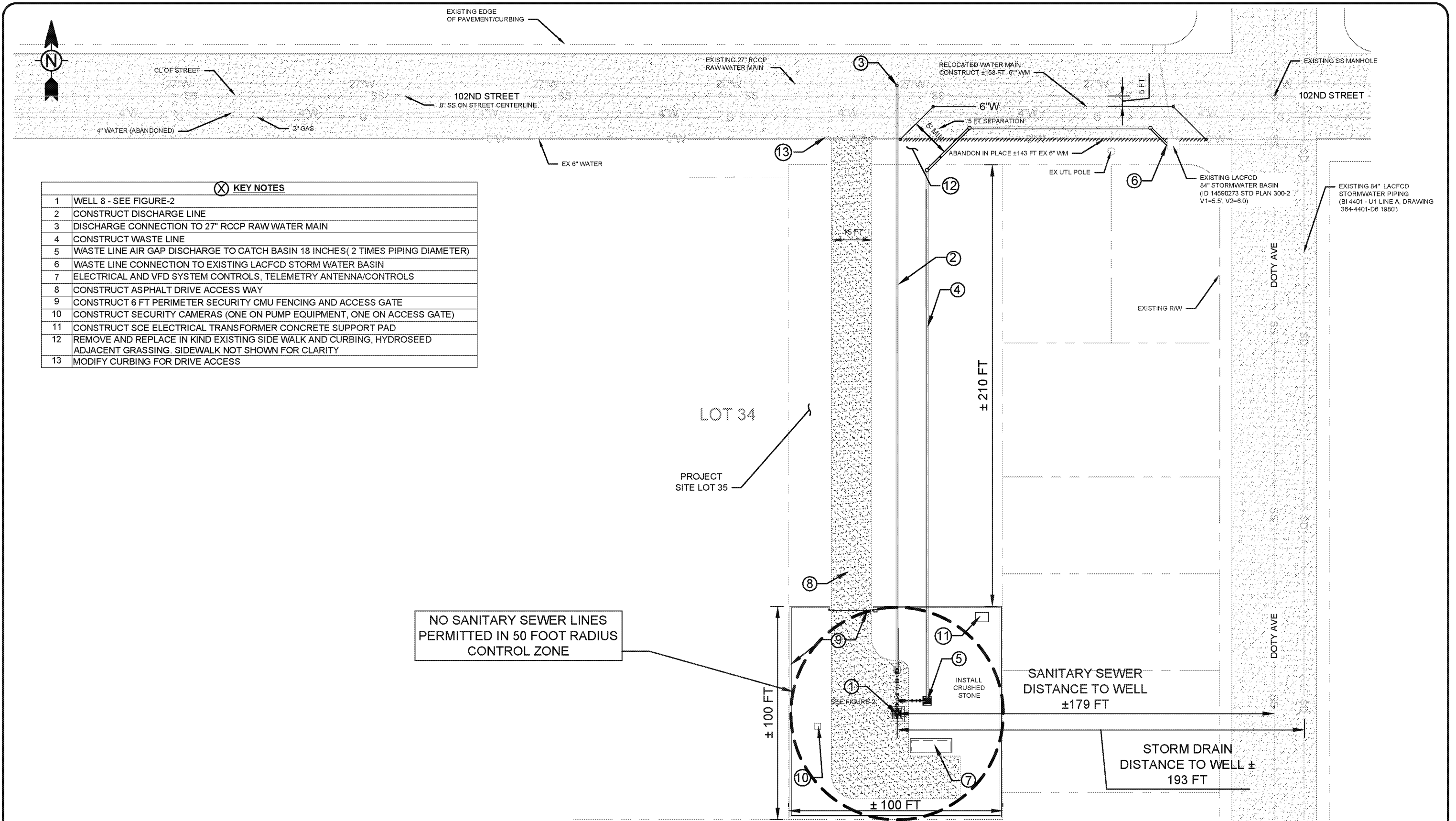

<p>PREPARED FOR</p> <p>MURPHY'S BOWL, LLC</p> <p>10400 BELLEVUE, WA 98004</p>	<p>TETRA TECH</p> <p>www.tetrattech.com</p> <p>160 East Via Verde Ave, Suite 240 San Dimas, CA 91773 T: (909) 305-2930 F: (909) 305-2959</p>	<p>City of Inglewood Well 8</p>	<p>Project No.: 200-202670-180001</p>
		<p>CITY OF INGLEWOOD</p> <p>WELL NO. 8</p> <p>DDW EXHIBIT</p>	<p>Date: Feb 2018</p> <p>Designed By: TT</p> <p>Figure FIGURE 1</p>

Bar Measures 1 inch NOT TO SCALE

Copyright: Tetra Tech

APPENDIX



RICHARD C. SLADE & ASSOCIATES LLC
CONSULTING GROUNDWATER GEOLOGISTS

**WELL SITE FEASIBILITY STUDY
AND
PRELIMINARY WELL DESIGN REPORT
FOR
PROPOSED WELL No. 8
CITY OF INGLEWOOD
LOS ANGELES COUNTY, CALIFORNIA**

Prepared For:
Tetra Tech Inc.

Prepared By:
Richard C. Slade & Associates LLC
Consulting Groundwater Geologists
Studio City, California

Job No. 106-LAS10-05

March 2018



**WELL SITE FEASIBILITY STUDY AND
PRELIMINARY WELL DESIGN REPORT
FOR PROPOSED WELL NO. 8
CITY OF INGLEWOOD
LOS ANGELES COUNTY, CALIFORNIA**

**PREPARED FOR:
TETRA TECH INC.**

**PREPARED BY:
RICHARD C. SLADE & ASSOCIATES LLC
CONSULTING GROUNDWATER GEOLOGISTS
STUDIO CITY, CALIFORNIA**

JOB NO. 106-LAS10-05

MARCH 2018

A handwritten signature in cursive script, reading 'Earl LaPensee'.

**Earl LaPensee
California Certified Hydrogeologist No. 134**

A handwritten signature in cursive script, reading 'Richard C. Slade'.

**Richard C. Slade
Professional Geologist No. 2998**



TABLE OF CONTENTS

<u>Section Title</u>	<u>Page</u>
TABLE OF CONTENTS	i
LIST OF ABBREVIATIONS/ACRONYMS USED IN REPORT	iii
EXECUTIVE SUMMARY.....	iv
INTRODUCTION	1
GENERAL FINDINGS.....	3
Local Well Construction Parameters	3
Local Hydrogeologic Conditions	4
Water Level Data.....	6
Pumping Rate Data	7
General Water Quality Conditions	8
Selected General Mineral and Physical Constituents	8
Detected Inorganic (Trace Metal) Constituents.....	9
Detected Volatile Organic Compounds (VOCs).....	10
Radiological Constituents.....	11
SITE SPECIFIC FINDINGS	12
Preliminary Hydrogeologic Considerations	12
Site Logistical Considerations.....	12
Permitting Elements	14
Clearances	15
POTENTIALLY CONTAMINATING ACTIVITIES	16
Inventory of Potentially Contaminating Activities	16
CONCLUSIONS.....	18
Well Site Feasibility	18
PRELIMINARY WELL DESIGN CRITERIA.....	19
Pilot Borehole Drilling and Reaming.....	19
Well Casing and Gravel Pack.....	20
Well Development	21
Downwell Testing.....	21
Preliminary Opinion of Probable Well Construction Costs.....	22
DESTRUCTION OF EXISTING WELL.....	23
Previous Work on the Existing Well.....	23
Recommended Destruction Procedures on the Well.....	24
Preliminary Opinion of Probable Well Destruction Costs.....	25
PRELIMINARY ASSESSMENT OF PUMPING RATES	26
CLOSURE	27



REFERENCES CITED28

FIGURES

- Figure 1 – Location of Proposed Well No. 8 Site
- Figure 2 – Generalized Stratigraphic Section for the Coastal Plain of Los Angeles County
- Figure 3 – Generalized Geologic Cross Section B-B' Inglewood Region
- Figure 4 – Generalized Geologic Cross Section G-G' Inglewood Region
- Figure 5 – Water Level Hydrograph of Well No. 1366C
- Figure 6 – Detailed Site Map
- Figure 7 – GeoTracker Map of Proposed Well Site and Vicinity
- Figure 8 – Preliminary Well Design Diagram, Proposed Well No. 8

TABLES

- Table 1 – Summary of Available Well Construction Data for City Water-Supply Wells
- Table 2 – Interpreted Depths and Thicknesses of Aquifer Systems, Proposed Well No. 8 Site
- Table 3 – Comparison of Available Post-Construction Pumping Data for City of Inglewood Wells
- Table 4 – Summary of Available Historic Groundwater Quality Data (1989 through 2017)
- Table 5 – Preliminary Assessment of Pumping Rates and Pump Depth Setting, Proposed City of Inglewood Well No. 8

LIST OF ABBREVIATIONS/ACRONYMS USED IN REPORT

The following provides a list of abbreviations that may be used more than once throughout this report and is provided for the convenience of the reader.

<u>Abbreviation</u>	<u>Full Description</u>
bgs	below ground surface
COCs	constituents of concern
DDW	Division of Drinking Water
DTSC	Department of Toxic Substances Control
DWR	California Department of Water Resources
Fe	iron
HSLA	high strength low alloy
LACDEHS	Los Angeles County Department of Environmental Health Services
LACFCD	Los Angeles County Flood Control District
LCS	low carbon steel
LUST	leaking underground storage tank
MCC	motor control center
MCL	Maximum Contaminant Level
Mn	manganese
NPDES	National Pollutant Discharge Elimination System
PCA	Potentially Contaminating Activity
PDR	Preliminary Design Report
PWL	pumping water level
RWQCB	California Regional Water Quality Control Board
SS	stainless steel
SWL	static water level
SWRCB	State Water Resources Control Board
TDS	total dissolved solids
TH	total hardness
THM	trihalomethane
TTI	Tetra Tech, Inc.
UST	underground storage tank
VOC	volatile organic compound
WQA	Water Quality Association
WRD	Water Replenishment District of Southern California
WTP	Water Treatment Plant
gpm	gallons per minute
gpm/ft ddn	gpm per foot of drawdown
mg/L	milligrams per Liter
µg/L	micrograms per Liter



EXECUTIVE SUMMARY

Hydrogeologic conditions for a proposed new well, herein referred to as City of Inglewood (City) Well No. 8, were evaluated in this Well Siting Feasibility and Preliminary Design Report (PDR). This proposed well is to replace existing City Well No. 6 at the address of 3812 W. 102nd St within the city, as recommended by Wilson Meany Inc (WMI). The property upon which Well No. 6 exists is located approximately 550 ft northwest of the proposed site for the new well; but because that Well No. 6 property is scheduled for re-development by others, existing Well No. 6 will need to be destroyed.

The purposes of this hydrogeologic evaluation were to: assess groundwater conditions and determine the feasibility of constructing a new municipal-supply water well at the proposed well site; and provide a preliminary well design for the new well. A pumping rate ranging from 1,500 to as 2,500 gallons per minute (gpm) may be possible from the aquifer systems encountered at the proposed well site.

Available data on existing wells in the region were obtained and reviewed for this project. These records included the following:

- Drillers' logs and other well construction data.
- Downhole geophysical logs (electric logs).
- Static water level (SWL) data.
- Pumping water level (PWL) data, pumping rate data, and specific capacity data.
- Groundwater quality data.

Review of the available information and data revealed that geologically young sediments of the Lakewood Formation (consisting of the Exposition and Gardena/Gage aquifers), and the underlying San Pedro Formation (consisting of the Hollydale, Jefferson, Inglewood, Silverado and Sunnyside aquifer systems), are generally present beneath the City. Beneath the proposed well site, these units range in depth from 110 ft below ground surface (bgs) for the shallowest Gage Aquifer, to 611 ft bgs to the bottom of the Sunnyside Aquifer system. Major geologic structures underlying the City include: the Gardena syncline, a significant U-shaped geologic downwarp in the sedimentary layers; the Charnock fault on the west; and the Newport-Inglewood fault zone on the east.

There are no available long-term and/or continuous SWL data or PWLs or specific capacity data for nearby existing City Well No. 6 to allow a determination of historic water level trends in the region of the proposed well site. However, long-term available water level data from Los Angeles County Flood Control District (LACFCD) Well 1366C (formerly Golden State Water Company Yukon Well No. 2, which was destroyed in 2001) has a period of record dating from 1944 through 2000. A plot of the SWLs from this well revealed that these levels have historically ranged in depth between approximately 100 and 170 ft bgs. Fluctuations in these SWLs over time appear to be directly affected by variations in rainfall events and recharge and by variations in the amounts of seasonal pumpage by wells in the area. Sporadic and more limited data for existing City Well No. 6, between 2003 and 2014 and, more recently, for February 2018, reveal SWLs ranging from approximately 78 to 179 ft bgs.

Data for post-construction pumping on those City water-supply wells for which were available were reviewed to determine a possible current pumping rate and specific capacity for a new well at the proposed site. These data revealed the following:

- SWLs ranged from 100 to 179 ft bgs.
- PWLs ranged from 168 to 245 ft bgs.
- Pumping rates ranged from 2,200 to 3,800 gpm.
- Water level drawdowns of 33 ft to 128 ft were reported.
- Specific capacity values ranged from 24 to 78 gallons per minute per foot of drawdown (gpm/ft ddn).

Thus, similar ranges in pumping rates, pumping water levels, and specific capacity values may be available for a new well at the proposed site.

Available historic groundwater quality data reveal that City wells in the area generally produce groundwater that is potable. However, in most of the City wells, the constituents of concern (COCs) are iron (Fe), manganese (Mn), and total dissolved solids (TDS). In some groundwater samples from certain City wells, each COC has occasionally been detected at concentrations which exceed its respective State Water Resources Control Board (SWRCB), Division of Drinking Water (DDW) applicable Primary or Secondary Maximum Contaminant Level (MCL). Because of the proximity of the proposed well site to existing City Well No. 6, it appears that water quality in the new replacement well will be generally similar to that of the existing well.

The results of this hydrogeologic evaluation reveal that it appears feasible to drill and construct a new well at the proposed well site that could have the potential to obtain pumping rates of up to 2,500 gpm. However, it is possible that groundwater pumped from the well might require treatment for at least TDS, Fe, and Mn. It is understood that the City is currently treating water pumped from its system of wells for Fe, Mn and TDS at its Sanford M. Anderson Water Treatment Plant (WTP).

The following describes the general conditions and overall well design parameters for the proposed well at the selected well site, based on available data and information on existing City Well No. 6:

- An anticipated pilot hole drilling depth of 750 ft bgs.
- Downhole isolated aquifer zone testing in the open borehole to evaluate potential water quality conditions, including TDS, Fe, Mn and perchlorate in the groundwater from a few selected aquifers underlying the well site.
- Construction of the well to a preliminary cased depth of 720 ft bgs, using 20-inch inside diameter (ID), Type 304L stainless steel casing. Final depth and design of the well to be based on the geophysical electric log, on the results of downhole isolated aquifer zone testing in the pilot hole, and on the results of the geological log of the drill cuttings from the pilot hole.
- A current SWL on the order of 130 ft bgs.
- Initial specific capacities possibly ranging from 30 to 40 gpm/ft ddn. However, these initial specific capacities will tend to decrease over time as the well ages.



- Preliminary costs for the drilling, construction, development and testing of the new well could range from \$1,000,000 to \$1,300,000 in accordance with the preliminary design parameters provided herein.

Destruction of existing City Well No. 6 is to be performed following completion of construction activities for the new well. This destruction should be performed under current Los Angeles County Department of Environmental Health Services (LACDEHS) requirements, which are generally based on California Department of Water Resources (DWR) standards for well destruction. Our preliminary opinion of the cost for destruction of this older, existing well is in the range of \$70,000 to \$90,000.



INTRODUCTION

This Well Site Feasibility and Preliminary Well Design Report presents our hydrogeologic findings and analyses of available data for a proposed municipal-supply water well that is to be constructed to replace nearby, existing City of Inglewood (City) Well No. 6. Also provided herein are our preliminary design recommendations for this new well, herein referred to as City Well No. 8. A production rate ranging from 1,500 to 2,500 gallons per minute (gpm), if available from the aquifer systems beneath the well site, is the target range for production desired by the City from the proposed well.

Figure 1, "Location of Proposed Well No. 8 Site," shows the location of the proposed well site that was evaluated for this study, along with the locations of former and existing City-owned wells in the region. Also shown are the locations of four Water Replenishment District of Southern California (WRD) multi-port groundwater monitoring wells. Figure 1 also illustrates the general geologic structure in the area, along with the locations and alignments of two prior geologic cross sections previously prepared by the California Department of Water Resources (DWR, 1961), which will be discussed in a succeeding section of this report.

The site for proposed City Well No. 8 is proximal to and southeast of existing Well No. 6, as shown on Figure 1. The geographic location information of the well site is as follows:

- Physical Address: 3812 W. 102nd St, Inglewood, CA 90304
- Public Land Survey System: NE¼, NE¼, SE¼, NW¼, NW¼, Section 3, Township 3 South, Range 14 West.
- Assessor's Identification Number (AIN): 4032-007-904
- GPS Coordinates: 33.943549°, -118.340261°

The purposes of this project were to assess groundwater conditions and determine the feasibility of constructing a new municipal-supply water well at the proposed well site, and to prepare a preliminary design for proposed City Well No. 8. The data and recommendations presented in this report can then be used by the RCS groundwater geologists to prepare the Technical Specifications and Line Item Bid Sheets for the future bidding, construction and testing of the new well.

Available data with regard to well construction, water levels, and water quality for the existing and former City wells were evaluated for this project and are summarized in the various tables in this report. Further, driller's logs, and available geologic logs and electric logs (E-logs) from

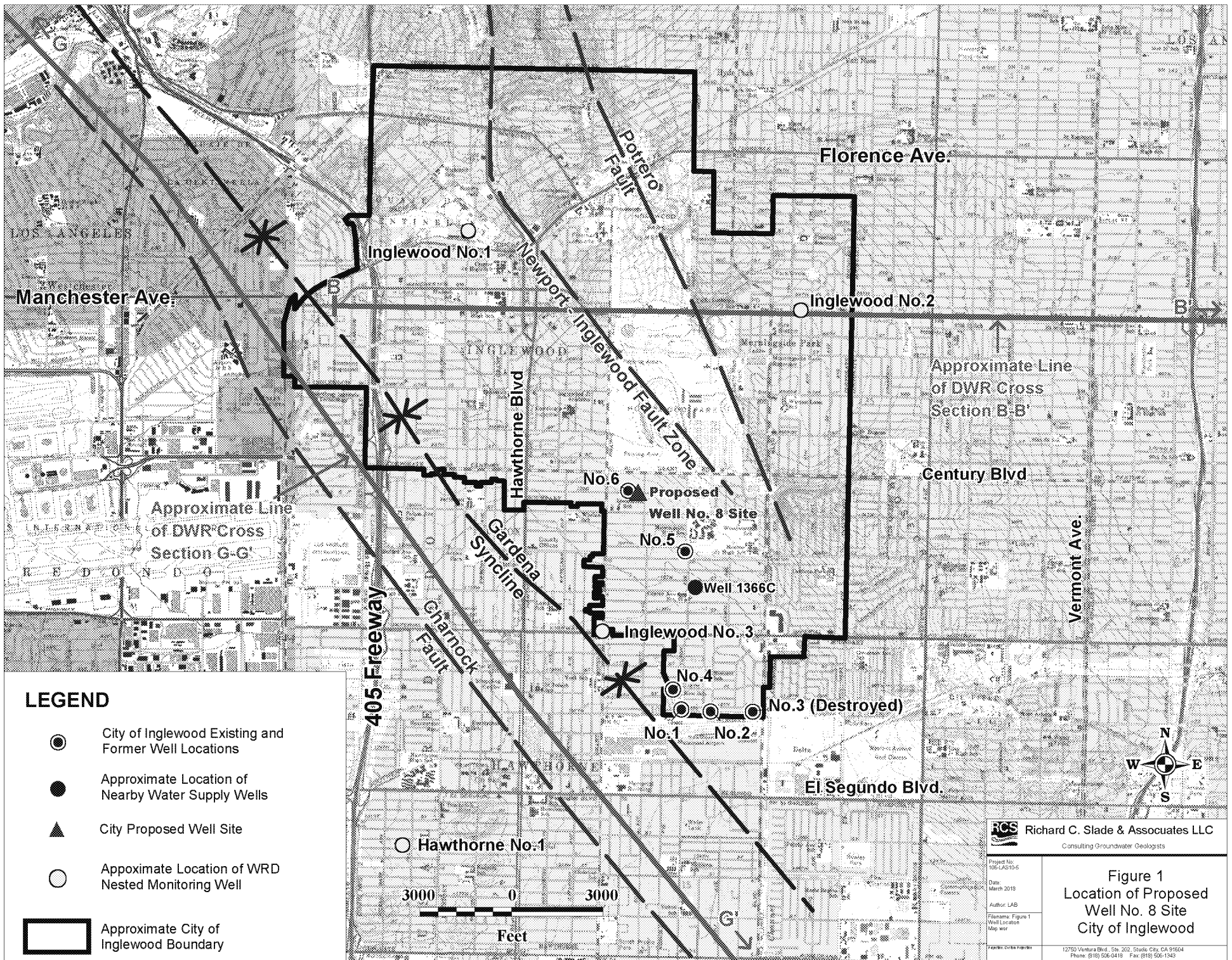

RCS Richard C. Slade & Associates LLC
 Consulting Groundwater Geologists

Project No.
 W-14210-5
 Date
 March 2019
 Author
 LAB
 Filename
 Figure 1
 Well Location
 Map.wxd
 Author
 RCS/RS/RS

Figure 1
 Location of Proposed
 Well No. 8 Site
 City of Inglewood

12750 Ventura Blvd., Ste. 302, Studio City, CA 91604
 Phone: (818) 506-0419 Fax: (818) 506-1343



the City wells and from the nearby WRD groundwater monitoring wells (namely, the Inglewood and Hawthorne groundwater monitoring wells, see Figure 1) were utilized by RCS to assess local subsurface geologic conditions and to determine the potential depths to the key aquifer systems beneath the proposed site.

GENERAL FINDINGS

Local Well Construction Parameters

Table 1 "Summary of Available Well Construction Data for City Water-Supply Wells," tabulates the key data that are available for the historic and existing wells within the City; Figure 1 illustrates the locations of the six City wells listed on Table 1. As noted on Table 1, two of the City-owned wells are currently inactive (No. 4 and No. 5) and another one was previously destroyed (No. 3). Note that City Well No. 5 was constructed, but never placed into service. The other three wells constructed for the City (Nos. 1, 2, and 3) are still active at this time.

The available drillers' logs were used to provide the data summarized on Table 1, and also to provide our assessment of the preliminary design criteria for the proposed well. The following briefly summarizes the well construction parameters listed on Table 1:

- All six wells were all constructed using the reverse circulation drilling method.
- Pilot hole drilling depths ranged from 790 ft bgs in Well No. 6, to 842 ft bgs for Well No. 1.
- Casing in the wells generally consisted entirely of 20-inch diameter steel set to depths ranging from 645 ft to 800 ft bgs; the only exception is Well No. 5 which was provided with 18-inch diameter casing to 310 ft bgs, and then with 14-inch diameter casing from 310 to 645 ft bgs.
- All constructed wells have sanitary seals and these seals range in depth from 270 ft to 328 ft bgs; a minimum 50-foot sanitary seal depth is needed to use the groundwater pumped from a well for domestic supply.
- Perforation intervals extend from depths as shallow as 320 ft bgs (in Well Nos. 2 and 5), to as deep as 780 ft bgs (in Well Nos. 1 and 4). Perforation slot sizes range from 0.0625 inches in some of the older wells, to 0.090 inches in the newer wells. Further, three of the listed wells have multiple perforation intervals, reflecting the interlayered sand/silt/clay nature of the sediments beneath the City. The total lengths of the perforated intervals in the wells range from 175 ft in Well No. 5, to 440 ft in Well No. 1.
- The gravel pack sizes range from 3/8-inch pea gravel to an 8 X 12 gradation.
- It is also notable that full liner casings were emplaced into Well Nos. 2 and 4 at some date after their respective construction. The liner casing in Well No. 2 is all 18 inches in diameter, whereas that for Well No. 4 is 18 inches to 350 ft bgs and 16 inches thereafter to its total depth of 800 ft bgs.

TABLE 1
SUMMARY OF AVAILABLE WELL CONSTRUCTION DATA
FOR CITY WATER-SUPPLY WELLS

CITY WELL NO.	STATE WELL NUMBER	YEAR DRILLED	DEPTH OF DRILLING (ft bgs)	DEPTH (ft bgs)/ DIAMETER (inches) OF CONDUCTOR CASING	ANNULAR CEMENT SEAL DEPTH (ft bgs)	CASING DIAMETER (in) & TYPE	TOTAL DEPTH OF CASING (ft bgs)	PERFORATION DEPTH INTERVAL (ft bgs)	TOTAL LENGTH OF PERFORATIONS (ft)	GRAVEL PACK GRADATION AND DEPTH INTERVAL (ft bgs)	TYPE & SIZE OF SLOT OPENINGS (in)	CURRENT STATUS OF WELL
1	03S14W10F1S	1974	842	62/36	0-328	20 LCS	800	340-780	440	minus 3/8 in 0-800	Moss Louvers 1/16 x 2 3/8	Active
2	03S14W10GS	1974 (Liner: 1999)	810	62/36	12-288	20 LCS (Liner: 18)	760 (Liner: 730)	320-740 (Liner: 306-730)	420 (Liner: 424)	minus 3/8 in 0-760 (Liner: 4 X 8 CSSI to ground surface)	Moss Louvers 1/16 x 2 3/8 (Liner: Screen, 0.070 slot)	Active
3	03S14W10HS	1974	812	62/36	12-328	20 LCS	690	360-670	310	minus 3/8 in. 350 to 690	Moss Louvers 1/16 x 2 3/8	Destroyed
4	03S14W10F2S	1990 (Liner: 1998)	806	50/36	0-270	20 LCS (Liner: 18 to 16)	800 (Liner: 18 to 350, 16 to 800)	340-440 480-780 (Liner: 350-430 & 480-780)	400 (Liner: 380)	3/8 Spec. 270-800 (Liner: 6 X 12 to ground surface)	Ful-flo Louvers 0.090 (Liner: Screen, 0.060 - 18", 0.050 - 16")	Inactive
5	03S14W03F2S	2001	800	50/36	0-280	18 from 0 to 310"; 14 from 310 to 645" LCS	645	320-390 520-625	175	6 X 12 CSSI 280-645	Ful-Flo Louvers 0.070"	Inactive & Inaccessible
6	03S14W03DS	2003	790	50/36	0-280; Bentonite & Sand 280-285	20 HSLA	670	345-385 510-650	180	8 X 12 285-760	Ful-flo Louvers 0.085"	Active

NOTES: Construction Data are per available State Well Completion Reports (aka "Driller's Logs").
 ND = No Data
 LCS = low carbon steel, HSLA = high strength low alloy steel
 All wells drilled & constructed using the reverse circulation method

Local Hydrogeologic Conditions

General Geologic Conditions

The key published report used to help define local hydrogeologic conditions was Bulletin 104, "Planned Utilization of the Groundwater Basins of the Coastal Plain of Los Angeles County," published by the California Department of Water Resources (DWR, 1961). Figure 2, "Generalized Stratigraphic Column for the Coastal Plain of Los Angeles County," has been adapted from that DWR reference to illustrate the general stratigraphy beneath the entire Los Angeles Coastal Plain, which encompasses the City of Inglewood. The earth materials listed on Figure 2 are generally representative of those that could be encountered during drilling at the proposed well site. Figure 3, "Generalized Geologic Cross Section B-B', City of Inglewood Region," and Figure 4, "Generalized Geologic Cross Section G-G', City of Inglewood Region," show the alignments of two different cross sections which traverse across portions of the City (as adapted from DWR Bulletin 104) to graphically show the aquifer systems which might occur in the subsurface beneath the City and the proposed well site (Figure 1 herein shows the locations of a portion of these two DWR cross section lines). These cross sections provide basic information on the names and approximate depths of potential aquifer systems and on the local geologic structure in the subsurface in the general vicinity of the City. The alignment for one cross section (section B-B', Figure 3) is along the center of the City (along Manchester Ave) and is oriented from west to east; the other cross section (section G-G', Figure 4) is oriented from northwest to southeast across the west side of the City (See Figure 1).

Figures 3 and 4 provide subsurface geologic profiles, from land surface downward beneath the study area. From geologically youngest to oldest, these figures (and Figure 2) show the subsurface earth materials to consist of the following:

- Recent alluvial and continental deposits of the Lakewood Formation of late Pleistocene age. The Lakewood Formation, which may have a maximum thickness of 300 ft in the region, contains the Exposition and Gardena/Gage aquifer systems.
- Additional but slightly older continental deposits of the San Pedro Formation of early Pleistocene age. Key aquifers in this formation are the Hollydale, Jefferson, Lynwood, Silverado and Sunnyside aquifer systems (the latter aquifer system, near the base of the San Pedro Formation, is of marine origin). The estimated maximum combined thickness of these named potential aquifer systems beneath the City is on the order of 400 to 450 feet.

Also, an important fact is that the Sunnyside aquifer near the base of the San Pedro Formation is generally known to have a lower permeability, when compared to that of the younger (and

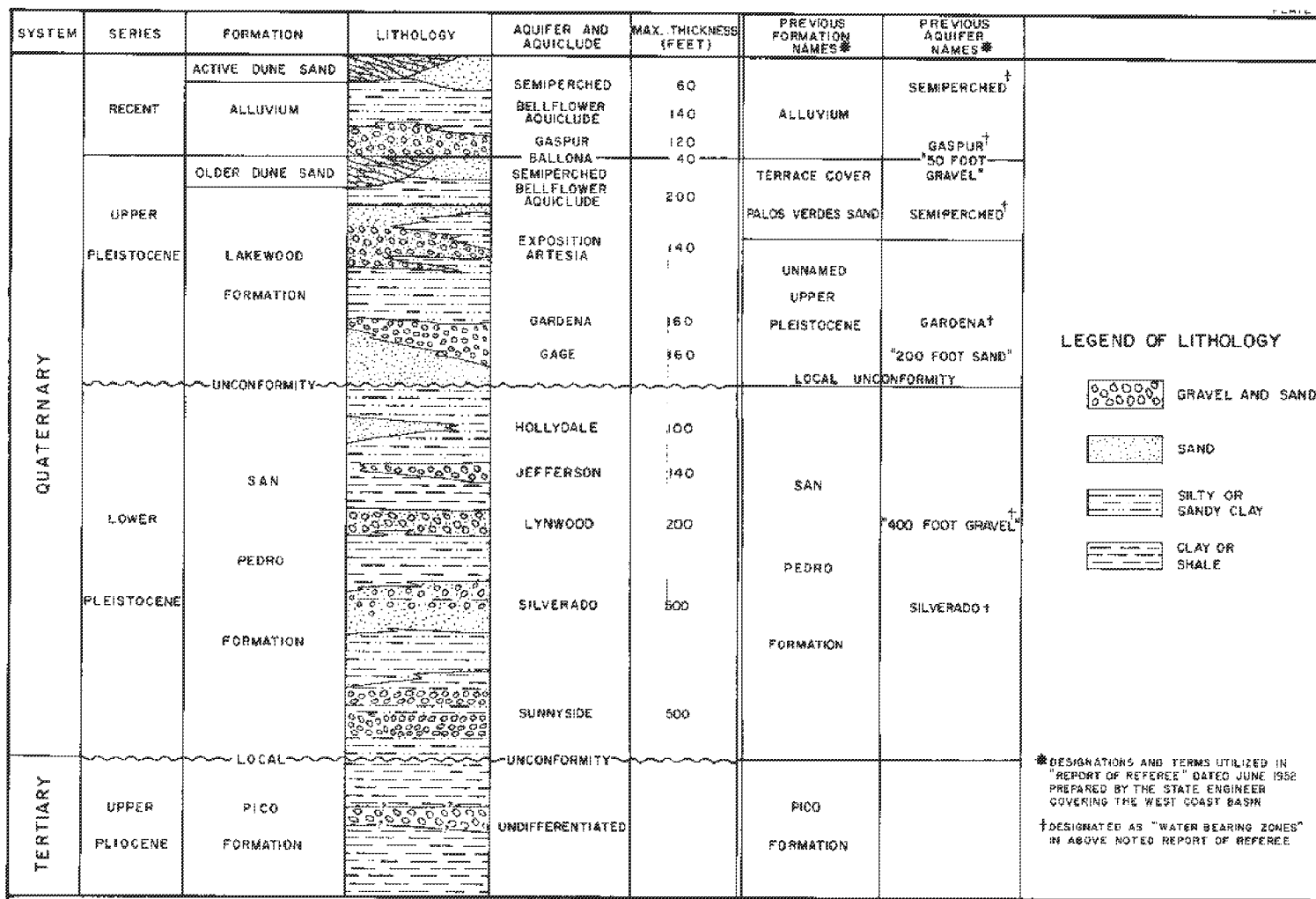

Modified from DWR Bulletin 104 (1961)

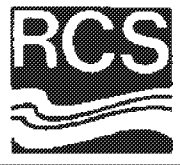

RICHARD C. SLADE & ASSOCIATES LLC
 CONSULTING GROUNDWATER GEOLOGISTS
 14051 Burbank Blvd., Suite 300
 Sherman Oaks, CA 91401
 Southern California (818) 506-0418
 Northern California (707) 963-3914
 www.rcslade.com

FIGURE 2
GENERALIZED STRATIGRAPHIC SECTION
FOR THE COASTAL PLAIN OF LOS ANGELES COUNTY

RCS Job No. 106-LAS10-5

March 2018

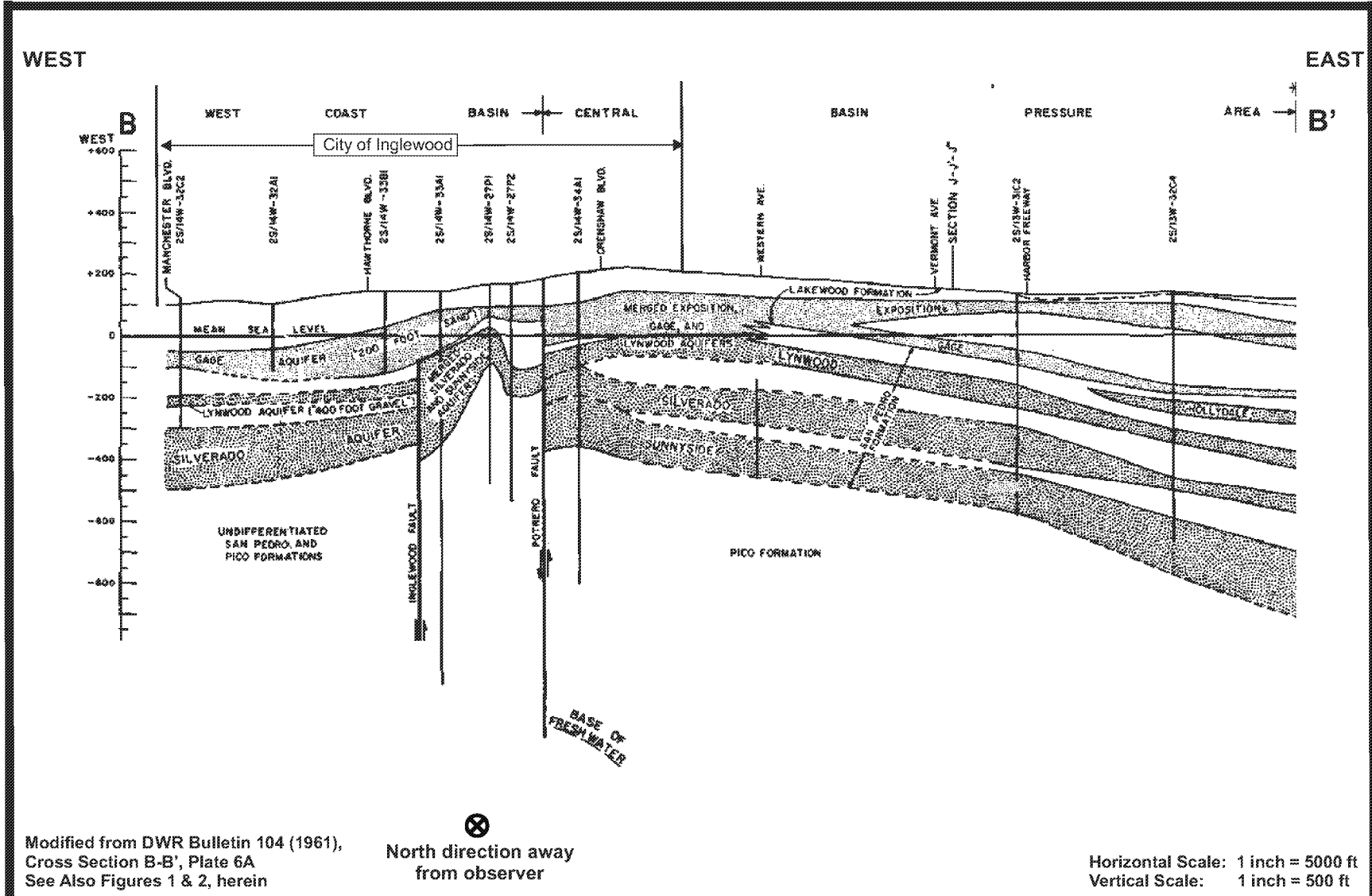

RCS
RICHARD C. SLADE & ASSOCIATES LLC
 CONSULTING GROUNDWATER GEOLOGISTS
 14051 Burbank Blvd., Suite 300
 Sherman Oaks, CA 91401
 Southern California (818) 506-0418
 Northern California (707) 963-3914
 www.rcslade.com

FIGURE 3
GENERALIZED GEOLOGIC CROSS SECTION B-B'
CITY OF INGLEWOOD REGION

RCS Job No. 106-LAS10-5 March 2018

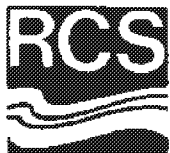
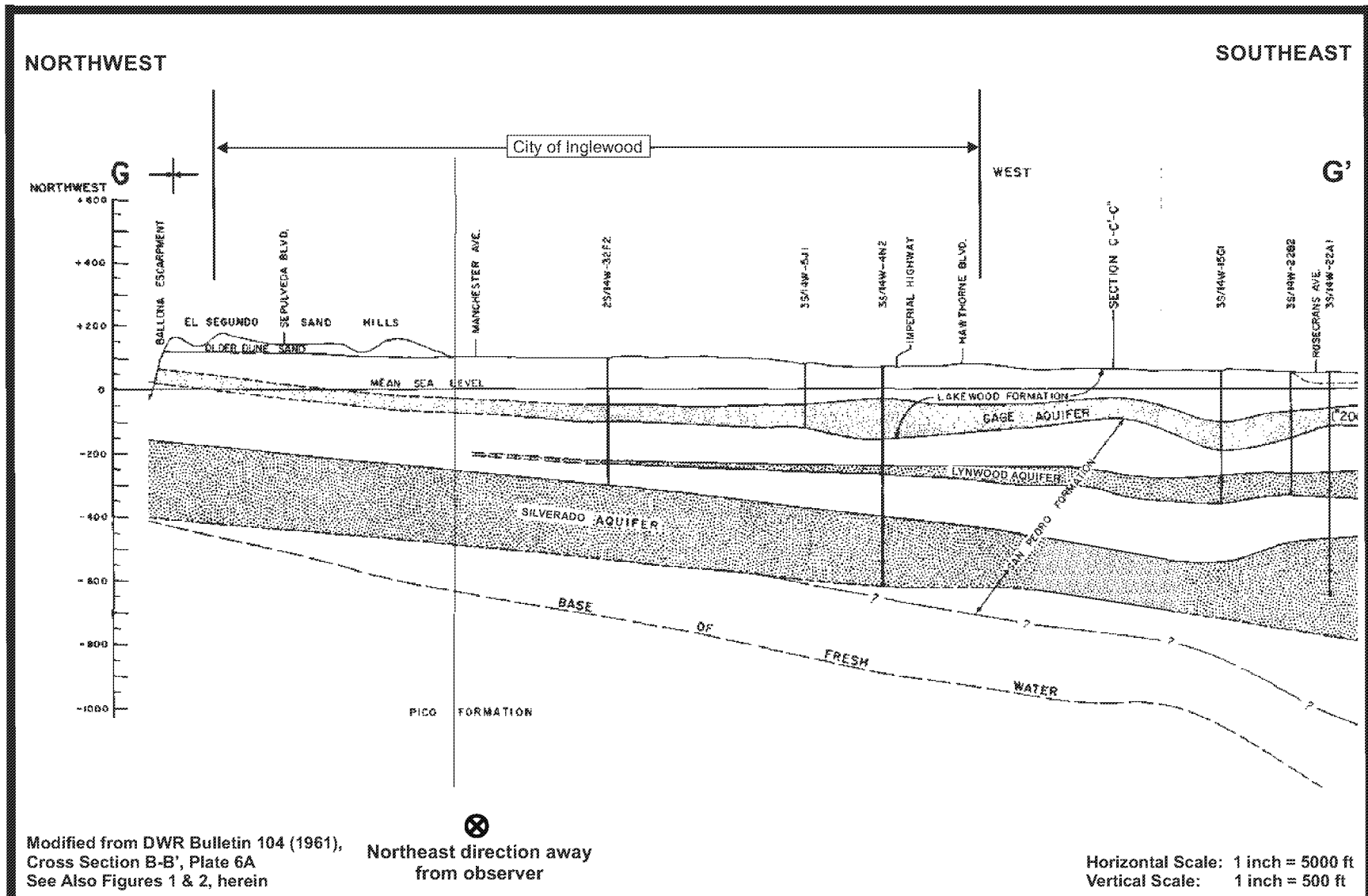

RICHARD C. SLADE & ASSOCIATES LLC
 CONSULTING GROUNDWATER GEOLOGISTS
 14051 Burbank Blvd., Suite 300
 Sherman Oaks, CA 91401
 Southern California (818) 506-0418
 Northern California (707) 963-3914
 www.rcslade.com

FIGURE 4
GENERALIZED GEOLOGIC CROSS SECTION G-G'
CITY OF INGLEWOOD REGION

RCS Job No. 106-LAS10-5

March 2018

overlying) aquifer systems of the San Pedro Formation. Further, the Sunnyside aquifer has the potential for containing slightly poorer water quality than that contained in the overlying aquifer systems. Hence, this relatively deep aquifer system will likely not be targeted as a zone to receive perforated casing in the proposed well, but it will be drilled into by the pilot borehole and then tested in this open borehole to evaluate certain water quality constituents and its potential yield. Should downhole in-situ water quality and potential yield data indicate favorable conditions at the drill site, then this aquifer system might also be perforated in the new well.

Underlying the above potentially water-bearing formations is the Pico Formation of late Pliocene age; it consists largely of marine-deposited sediments. These underlying and geologically older deposits of the Pico Formation are generally considered to be non-water bearing for municipal water-supply purposes. This formation may have a thickness of several thousand feet in the area.

There are a few major geologic structures in the study area. One such structure, the Gardena syncline (see Figure 1), is a broad northwest-trending, U-shaped downwarp in the sediments; the ground surface trace of the axis of this syncline generally trends from the northwest to the southeast across the southwest edge of the City and plunges toward the southeast. Such a structure is significant because the thicknesses of the potential aquifer systems will tend to change across the City, such that those potential well sites that lie closest to the axis of this syncline will tend to have the greatest combined thickness of the underlying aquifer systems, and vice versa. In addition, as the syncline is followed to the southeast (i.e., in the direction that the axis of the syncline plunges, or deepens), the sediments would tend to deepen and thicken, due to the plunging character of the axis of this fold.

The Gardena syncline is bounded by two other important geologic structures: the Charnock fault to the southwest and the Newport-Inglewood fault zone to the northeast (see Figure 1). Both faults generally trend from northwest to southeast and are the main cause of the downwarping of the sediments in the southwestern portion of the City. The degree to which these faults might serve as potential barriers to local groundwater flow is not known.

Correlation of Electric Logs

To obtain possible depths to and thicknesses of the principal aquifer systems from which the proposed new well would likely obtain its supply (mainly, the Silverado aquifer), we reviewed available drillers' logs and conducted a preliminary electric log (E-log) correlation (not provided herein) for wells with available E-logs (these include a few City wells and the local WRD

groundwater monitoring wells). Based on our interpretation and correlation of these few E-logs, Table 2, "Interpreted Depths and Thicknesses of Aquifer Systems, Proposed Well No. 8 Site" shows the depths and thickness of the aquifer systems that would likely be encountered at the proposed replacement well site.

Review of that table shows that the top of the target aquifer system, the Silverado aquifer may range from approximately 420 ft bgs to 620 ft bgs, and this aquifer may have a thickness of approximately 200 ft. Thus, the top of the perforations in the proposed well could be placed at the top of this aquifer system. However, it is also possible that the overlying aquifer system, the Lynwood aquifer, could also be used as an additional supply but this will be contingent on the ultimate water quality conditions observed during isolated aquifer zone testing that is to be performed in the open pilot hole for the proposed well. If it is shown that this aquifer can also be utilized, then the perforations could be placed as shallow as approximately 270 ft bgs.

Water Level Data

RCS geologists analyzed available historic static water level (SWL) data to help discern possible long-term changes in those levels over time. Long-term accumulations of water level data for individual wells are very useful records because these records can be used to help determine the historically highest and lowest SWLs over time, and to also help define possible trends in water levels over time. Furthermore, current SWLs can then be compared to those that have been recorded over time.

Historic SWL data were also obtained from the Los Angeles County Department of Public Works (LACDPW). These data were reviewed and one of the wells monitored by LACDPW, namely Well No. 1366C, was formerly owned by Golden State Water Company (GSWC). This well, known as the GSWC Yukon No. 2, was destroyed in July 2001. Data from this well were selected for analysis because its water level data had a relatively long period of continuous record (1944 to 2001). Well No. 1366C is located in the City (see Figure 1), approximately 1,000 ft southeast of the proposed well site.

Figure 5, "Water Level Hydrograph of Well No. 1366C," is a plot of the available SWL data from that well showing the pattern of water level changes over its 57-year period of record. Figure 5 reveals that SWLs in this well have ranged in depth from approximately 101 ft bgs in early-1995, to approximately 165 ft bgs in late-1968, which amounts to a total fluctuation between these two data points of approximately 64 ft. The last measured water level in Well No. 1366C (in 2001), at a depth of approximately 104 ft bgs, is 61 ft above the lowest measurement of 165

**TABLE 2
 INTERPRETED DEPTHS AND THICKNESSES OF AQUIFER SYSTEMS
 PROPOSED WELL NO. 8 SITE**

Aquifer System	Depth Interval (ft bgs)	Approximate Thickness (ft)
Gage	100 to 255	155
Lynwood	265 to 370	105
Silverado	420 to 620	200
Sunnyside	630 to 700	70

NOTES: bgs = below ground surface

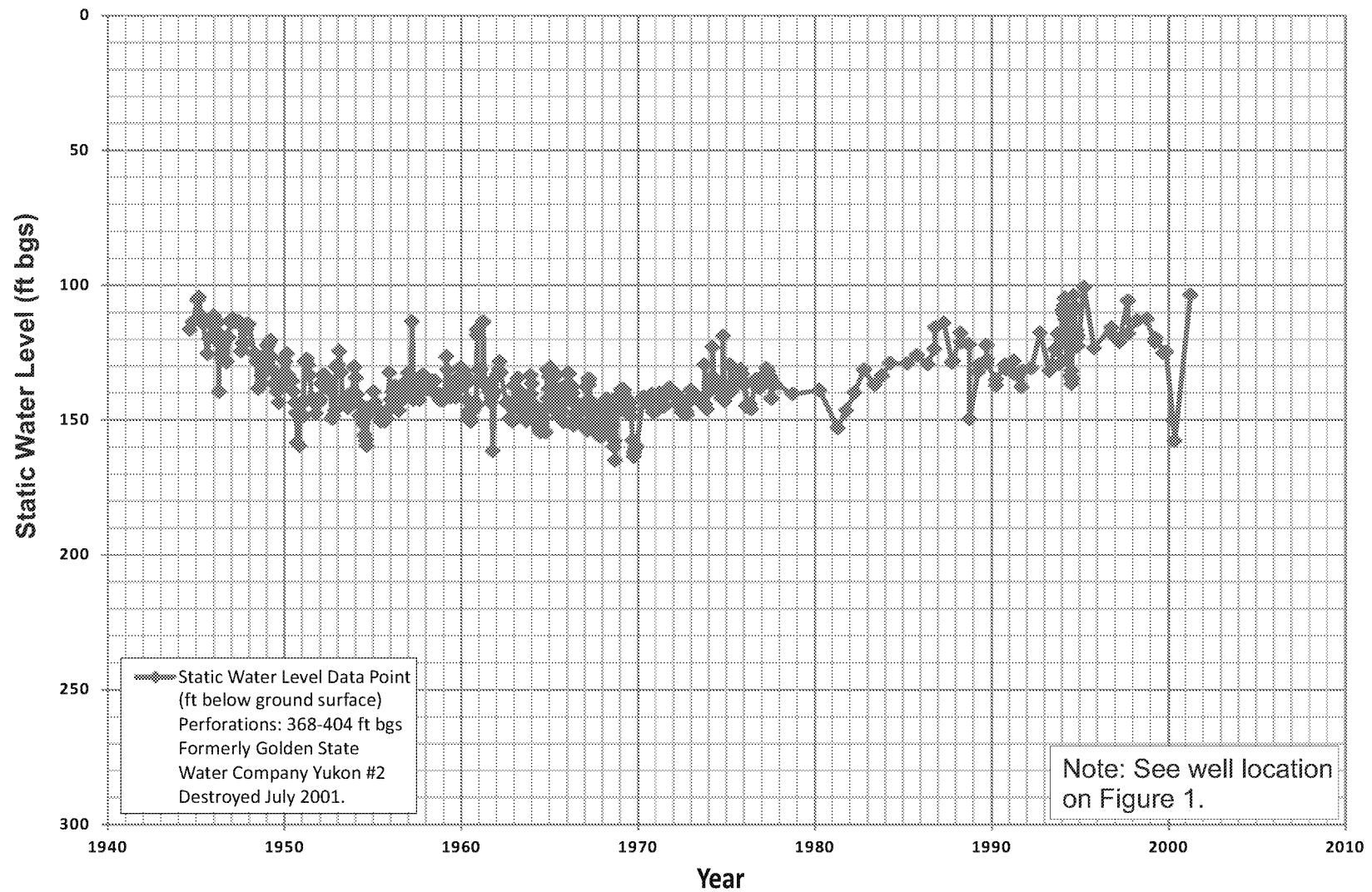

RICHARD C. SLADE & ASSOCIATES LLC
CONSULTING GROUNDWATER GEOLOGISTS
 14051 Burbank Blvd., Suite 300
 Sherman Oaks, CA 91401
 Southern California (818) 506-0418
 Northern California (707) 963-3914
www.rcslade.com

FIGURE 5
WATER LEVEL HYDROGRAPH OF
WELL NO. 1366C

RCS Job No. 106-LAS10-5

March 2018

ft bgs for the period of available data. Generally, SWLs in the area for the proposed well site could be similar in depth and to have similar patterns (fluctuations) over time as those seen on Figure 5 for Well No. 1366C.

There are very little historic long-term SWL data available for any of the City water-supply wells, including City Well No. 6, because this well was recently constructed in 2003. However, based on Table 3, "Comparison of Available Historic Post-Construction Pumping Data for City of Inglewood Wells," SWLs in the existing well may have been between 117 ft and 179 ft bgs. In addition, sporadic data from City Well No. 6 were also documented on available video surveys and by the occasional testing by others. The following lists the available data:

- Original testing of Well No. 6 in October 2003 shows a SWL of 117 ft.
- A video survey performed by Layne Christensen in November 2007 documents a SWL of 119 ft bgs.
- A Southern California Edison (SCE) test report in September 2008 reports a SWL of 167 ft bgs.
- Testing conducted by GeoTrans, Inc. and BESST Inc. (GeoTrans, April 10, 2010) reports a SWL at a depth of 120 ft bgs, in February 2010.
- An October 2011 SWL of 117.5 ft bgs was reported in another Layne video survey, prior to rehabilitation operations in that well.
- A February 15, 2013-dated Layne video shows a SWL of 115.8 ft bgs.
- Longmire Swaging, Inc. (Longmire) of Lemoore, California performed video surveys associated with the placement of patches; these surveys showed SWLs to be at depths of 127 ft, 117.5 ft, 89 ft, and 78 ft bgs, on August 25, 2011, October 10, 2011, September 19, 2014 and November 24, 2014, respectively.

A more recent SWL reported for Well No. 6 by the City for February 2018 (Mr. Thomas Lee, email communication February 27, 2018) was at a depth of 130 ft bgs. Thus, over the history of Well No. 6, SWLs have ranged from 78 ft to 130 ft bgs. It is likely that such SWL changes would be similar in the proposed new well.

Pumping Rate Data

Available pumping data just following construction of the City wells were obtained from original driller's log data and prior well construction reports prepared for the City. Such post-construction data are representative of the possible production capacity of proposed new Well No. 8 immediately following its construction, because those data were collected when construction of each well had been recently completed. These data reveal the following general pumping conditions for former and existing City wells:

**TABLE 3
COMPARISON OF AVAILABLE POST-CONSTRUCTION PUMPING DATA
FOR CITY OF INGLEWOOD WELLS**

CITY WELL NUMBER	PERFORATION DEPTH INTERVALS (ft bgs)	TEST DATE	REPORTED STATIC WATER LEVEL (ft bgs)	REPORTED PUMPING RATE (gpm)	REPORTED PUMPING WATER LEVEL (ft bgs)	REPORTED WATER LEVEL DRAWDOWN (ft)	ORIGINAL SPECIFIC CAPACITY (Q/s, in gpm/ft of drawdown)
1	340-780	Dec-1974	104	3,000	176	72	41.7
2	320-740	Nov-1974	100	3,000	168	68	44.1
3	360-670	Nov-1974	ND	2,500	ND	110 (reported on log)	ND
4	340-440 480-780	Sep-1992	179	2,573	212	33	78.0
5	320-390 520-625	Jun-2001	150	2,200	242	92	23.9
6	345-385 510-650	Oct-2003	117	3,800	245	128	29.7

NOTES: gpm = gallons per minute
bgs = below ground surface
ND = No Data

- Initial, post-construction data for the wells show that original pumping rates when the wells were first constructed range from a low of 2,200 gpm in Well No. 5, to as high as 3,800 gpm in Well No. 6.
- Original post-construction pumping water levels (PWLs) in the listed wells ranged from as shallow as 168 ft bgs in Well No. 2 in 1974, to as deep as 245 ft bgs in Well No. 6 in 2003.
- Water level drawdowns have reportedly ranged from 33 feet in Well No. 4 in 1992, to 128 feet in Well No. 6 in 2003, based on SWLs ranging from 100 to 179 ft bgs.
- Original specific capacity (SC) values, based on the above initial pumping data, have been in the range of 23.9 to 78 gpm per foot of drawdown (gpm/ft ddn).

There appears to be a slight correlation between pumping rates and depth of the perforation intervals when using the wells that have been in service for a greater number of years (Wells Nos. 1 to 4). That is, those wells with the shallowest perforation intervals appear to have slightly higher pumping rates and SC values compared to the other two wells, which have their uppermost perforations starting at somewhat greater depths. However, there are insufficient data to establish a strong relationship between perforation interval depths and pumping characteristics.

General Water Quality Conditions

Table 4, "Summary of Available Historic Groundwater Quality Data (1989 through 2017)" summarizes water quality data obtained directly from the water quality database of the State Water Resources Control Board (SWRCB) Division of Drinking Water (DDW) for those City-owned wells recorded in that database.

Selected General Mineral and Physical Constituents

The following provides a summary of the concentrations of key water quality constituents from the DDW database (also see Table 4):

- a. The groundwater from the local aquifer systems beneath the City appears primarily to have a mixed cation, calcium-sodium-bicarbonate (Ca-Na-HCO₃) character.
- b. Total dissolved solids (TDS) concentrations range from 277 milligrams per Liter (mg/L) to 630 mg/L. The current DDW Secondary (Recommended) Maximum Contaminant Levels (MCLs) for TDS are: 500 mg/L (lower); 1,000 mg/L (upper); and 1500 mg/L (short-term). Hence, the detected concentrations range from below to above the lower recommended DDW Secondary MCL, but below the short-term Secondary MCL for TDS. Generally, most of the detected TDS concentrations in samples from those City wells were below the lower recommended MCL. The five elevated detections of TDS (between 500 and 630 mg/L) were primarily from samples collected from Well No 6 between 2006 and 2011.

**TABLE 4
SUMMARY OF AVAILABLE HISTORIC
GROUNDWATER QUALITY DATA
(1989 THROUGH 2017)**

Constituent Analyzed	Units	Maximum Contaminant Level	Well No. 1	Well No. 2	Well No. 4	Well No. 6
General Perforation Interval:			340-780	320-740	340-440 480-780	345-385 510-650
Year(s) of Record>>>			1989-2015	1989-2015	1992-2017	2003-2017
General Physical Constituents						
Turbidity	NTU	5 (S)	0.18-30	ND-8.5	ND-66	ND-2
Specific Conductance	µmhos/cm	900; 1,600; 2,200 ⁽¹⁾ (S)	500-920	540-675	550-760	650-1,100
pH	units	6.5 to 8.5 (S)	7.2-8.2	7.6-8.3	7.6-8.1	7.6-7.9
Color	CU	15 (S)	ND-200	ND-30	ND-25	ND-10
Odor	TON	3 (S)	ND-8	ND-40	ND-4	ND-5
General Mineral Constituents						
Total Dissolved Solids	mg/L	500; 1,000; 1,500 ⁽¹⁾ (S)	277-540	320-390	281-460	380-630
Total Organic Carbon		None	0.66-5.5	0.4-2.2	0.6-3.8	ND-3.5
Total Hardness		None	120-180	152-207	167-210	200-350
Ammonia		None	1.3-5.9	0.53-2.6	0.88-3.6	ND-2.2
Calcium		None	27-48	40-56	44-61	54-96
Magnesium		None	11.4-15	14-16.4	12.3-18	15-26
Sodium		None	48.5-150	51-69	45.3-83	50-70
Potassium		None	4.4-14	2.9-6.8	4.5-9.3	3.6-7
Bicarbonate (HCO ₃)		None	263-460	240-320	278-380	210-280
Sulfate		250; 500; 600 ⁽¹⁾ (S)	0.5-6.7	2.7-53	0.69-7.7	49-60
Chloride		250; 500; 600 ⁽¹⁾ (S)	28-56	30-120	31-67	64-180
Fluoride		2 (P)	0.21-0.5	0.29-0.42	0.24-0.7	0.2-0.3
MBAS (Surfactants)		0.5 (S)	ND-0.07	ND	ND	ND-0.03 (2003) ⁽²⁾
Nitrate as NO ₃		45 (P)	ND-0.68	0.08 (1989) ⁽²⁾	ND	ND
Inorganic Constituents (Trace Elements)						
Aluminum	µg/L	200 (S), 1,000 (P)	ND-480	ND-540	ND-111	ND-8.8 (2004) ⁽²⁾
Arsenic		10 (P)	ND-1.0 (1989) ⁽²⁾	ND	ND	ND
Barium		1,000 (S)	ND-110	ND-26	ND-32	ND-100
Boron		1,000 (NL)	160-460	200-450	150-270	ND-110 ⁽²⁾ (2003)
Cadmium		5 (P)	ND-3 (1989) ⁽²⁾	ND	ND	ND
Chromium (Total)		50 (P)	ND-14 (1989) ⁽²⁾	ND-6 (1997) ⁽²⁾	ND-0.22 (2006) ⁽²⁾	ND-0.24 (2008) ⁽²⁾
Copper		1,300 (AL)	ND-9	2.1-21	ND-7.1	ND-15
Iron		300 (S)	ND-13,000	ND-1,565	ND-910	ND-5,500
Lead		15 (AL)	ND-2 ⁽²⁾ (1989)	ND-5	ND-3.3 (1989) ⁽²⁾	ND-0.47
Manganese		50 (S)	ND-670	ND-540	ND-170	ND-220
Mercury		2 (P)	ND-2 (1989) ⁽²⁾	ND-0.9 (1991) ⁽²⁾	ND	ND
Nickel		100 (P)	ND	ND	ND	ND-1.1 (2004) ⁽²⁾
Selenium		50 (P)	ND-1 (1989) ⁽²⁾	ND-2 (2006) ⁽²⁾	ND	ND
Silver		100 (S)	ND-7 (1989) ⁽²⁾	ND	ND	ND
Zinc		5,000 (S)	ND-46	ND-26 (1991) ⁽²⁾	ND	ND-14
Detected Volatile Organic Compounds						
Dichloromethane		5 (P)	0.84 (1999) ⁽²⁾	ND	ND	ND
Total Trihalomethanes (THMs)		80 (P)	ND	5.2 (2004) ⁽²⁾	ND	ND
Detected Radiological Constituents						
Gross Alpha	pCi/L	15 (P)	0.6-3.2	0.22-4.87	0.026-3.5	0.148-4.31
Radium-228		5 (P)	0.044 (2008) ⁽²⁾	0.223-0.298	0.012-0.47	0.274(2004) ⁽²⁾
Uranium		20 (P)	ND	0.3 (2002) ⁽²⁾	ND	ND

NOTES: (1) The three listed numbers represent the recommended, upper and short-term State Maximum Contaminant Levels for the constituent.
(2) The listed concentration number is based on and/or reported for one sample.
The year in parenthesis is the date of the reported detection.

ND = Not Detected

MCL limits in parentheses are as follows: P - Primary, S = Secondary, AL = Lead-Copper Rule Action Level, NL = Notification Level

Units: CU = color units, NTU = Nephelometric Turbidity Units, TON = total odor units, mg/L = milligrams per Liter,

µg/L = micrograms per Liter, µS/cm = microSiemens/cm (equivalent to µmhos/cm), pCi/L = picocuries per Liter.

- c. Total hardness (TH) concentrations have ranged from 120 to 350 mg/L. These values place the water in the hard to very hard range (120 to above 180 mg/L) according to the U.S. Geological Survey classification system for hardness (Durfor & Becker, 1962).
- d. The pH of groundwater has ranged from 7.2 to 8.3, indicating that the water is above neutral (7.0).
- e. Sulfate was detected at values ranging from 0.5 mg/L to 60 mg/L in the wells. The DDW Secondary MCL for sulfate is 250 mg/L and hence the reported concentrations of this constituent for all six City wells are below this MCL.
- f. Chloride was reported at values ranging from 28 to 180 mg/L in groundwater samples from the wells. The DDW Secondary MCL for this constituent is also 250 mg/L and the detected concentrations of this constituent are below the MCL for chloride in all wells.
- g. Fluoride was reported to be present in concentrations generally ranging from 0.21 to 0.7 mg/L. These reported concentrations are below the DDW Primary MCL of 2 mg/L for this constituent.
- h. Nitrate (as NO₃) concentrations ranging from not detected (ND) to 0.68 mg/L were reported. The current DDW Primary MCL for nitrate as NO₃ is 45 mg/L and, hence, the reported results are below this MCL value for all wells.

Detected Inorganic (Trace Metal) Constituents

The trace metals detected in groundwater samples collected from the wells are listed in Table 4, and are summarized below:

- a. Aluminum (Al) concentrations were reported at concentrations between ND and 540 micrograms per Liter (µg/L). The presence of Al in groundwater samples may be indicative of analysis of turbid water samples in the laboratory; Al is usually not found as a dissolved constituent in groundwater. The DDW Secondary MCL for Al is 200 (µg/L) and its Primary MCL is 1,000 µg/L. The reported concentrations of this constituent range from below to above the secondary MCL, but below the Primary MCL. Notice that the highest reported Al concentrations are from Well Nos. 1 and 2 (the two oldest wells). The high Al concentrations were detected in a Well No. 1 groundwater sample collected in 1996 and a Well No.2 groundwater sample collected in 2000; neither of the wells had a detection for this constituent since those dates.
- b. Detected arsenic (As) concentrations ranged from ND to 1.0 µg/L. The current Federal Environmental Protection Agency (EPA) Primary MCL for As is 10 µg/L and hence all detected As concentrations are below this MCL. It should be noted that As was reportedly detected in only one sample and this was from only one well, Well No. 1; its reported concentration was 1.0 mg/L in 1989 (see Table 4).
- c. Barium (Ba) was reported at concentrations between ND and 110 µg/L. The DDW Secondary MCL for this constituent is 1,000 µg/L. Thus, Ba is currently below this MCL in all the wells.
- d. Boron (B) was detected at concentrations ranging from 110 to 460 µg/L. The DDW has established a notification level (NL) of 1,000 µg/L for this constituent. The reported concentrations do not exceed this NL.

- e. Chromium was reported at concentrations ranging from ND to 14 µg/L. These concentrations are below the DDW Primary MCL of 50 µg/L for this constituent. This constituent was detected only once in each of the wells, as noted in Table 4.
- f. Copper was reported at concentrations ranging from ND to 21 µg/L. These concentrations are below the DDW "Action Level" of 1,300 µg/L for this constituent.
- g. Iron (Fe) was present at concentrations ranging from ND to as high as 13,000 µg/L. In those groundwater samples with the reported detections, Fe was generally present well above its DDW Secondary MCL of 300 µg/L. The data were reviewed for possible correlation between the location of the well, the date of sample, or the depth to the uppermost perforations in each well, but no obvious correlations could be established. The unusually high concentrations of Fe on Table 4 (e.g., 13,000 µg/L in Well No. 1, or 5,500 µg/L in Well No. 6) likely relate to laboratory testing of a turbid water sample.
- h. Lead was reported at concentrations ranging from 0.43 to 5 µg/L. These concentrations are below the DDW Primary MCL of 15 µg/L for this constituent.
- i. Manganese (Mn) was listed in the DDW database at concentrations ranging from ND to 670 µg/L. These reported concentrations in all the wells were above the current DDW Secondary MCL of 50 µg/L for Mn in one or more occasions historically. Again, as with Fe, the reviewed data exhibited no trends in concentration changes either by well location, sample date, or perforation depth interval of the well.
- j. Mercury was reported at concentrations ranging from ND to 2 µg/L. These concentrations are below or equal to the DDW Primary MCL of 2 µg/L for this constituent. Only two detections of the sample were reported in each of two wells, Nos. 1 and 2 in 1989 and 1991, respectively.
- k. Selenium was reported at concentrations ranging from ND to 2 µg/L. These concentrations are well below the DDW Primary MCL of 50 µg/L for this constituent. Again, this constituent was reported only twice, once in each of two wells, Nos. 1 and 2 in 1989 and 2006.
- l. Zinc was reported at concentrations ranging from ND to 46 µg/L. These concentrations are well below the CPDH Primary MCL for zinc of 5,000 µg/L.

Noteworthy is that perchlorate has not been reported in groundwater samples from any of the City wells and, especially, nearby City Well No. 6. This is significant as this constituent was considered by others to be a contaminant of concern (COC) for Hollywood Park Racetrack (see following section on Potentially Contaminating Activities).

Detected Volatile Organic Compounds (VOCs)

Only two VOCs were detected in samples from the listed wells on Table 4. This VOC, total trihalomethanes (THMs), was detected in only one groundwater sample from Well No. 2, where its THM concentration was 5.2 µg/L in 2004. However, because there was only one reported detection of THM and because this concentration is below the DDW MCL for THM of 80 µg/L, this constituent does not currently appear to pose a problem. Further, THM is often a byproduct

of disinfection and this could be a reason for the reported detection. The second VOC, dichloromethane, was detected in only one sample collected from Well No. 1, 1999.

Radiological Constituents

The DDW database revealed that a few radiological constituents were detected in the listed wells; Table 4 shows that Gross Alpha, Radium 228, and Uranium were detected. All detected radiological constituents in the City wells were below their respective DDW MCLs (see Table 4).

Water Treatment

Currently, the City treats the water it pumps from its existing wells at a facility located in the northern portion of the City, namely the Sanford M. Anderson WTP located at 359 North Eucalyptus Ave. Generally, this plant is reportedly capable of treating the water for Fe, Mn and TDS. Thus, water pumped from the proposed new well can also be treated by this facility; a water systems engineer will need to consider this in the design of the infrastructure for the proposed new well.



SITE SPECIFIC FINDINGS

A site reconnaissance of the well site (selected by WMI) was performed on March 5, 2018 by an RCS geologist. Generally, this site is a rectangular parcel of land located on the south end of the City, south of the former Hollywood Park Racetrack, and east of the intersection of Doty Ave and 102nd St. Figure 1 shows the location of this site relative to the City boundaries, whereas Figure 6, "Detailed Site Location Map" illustrates the location of the site and surrounding cultural features on an aerial photograph base map, adapted from Google Earth®. The following describes the general subsurface geologic conditions and pertinent logistical considerations at the selected well site.

Preliminary Hydrogeologic Considerations

Existing Well No. 6 lies about 550 ft northwest of the proposed well site, whereas the other five City wells (Well Nos. 1 to 5) lie to the south-southeast (see Figure 1). These City wells serve as adequate analogs for the proposed well at the 3812 102nd St site. Based on our data review, the following hydrogeologic conditions are anticipated at the selected site:

- Based on the driller's logs, the estimated depth range of the entire Silverado aquifer system could be from 450 ft to 650 ft bgs; the Sunnyside aquifer may extend from ±630 ft to 700 ft bgs. However, a pilot hole at the site could be drilled to a maximum depth of 750 ft bgs to intercept the entire Silverado aquifer and the underlying Sunnyside aquifer as well.
- An estimated SWL on the order of 160 ft bgs.
- A potential pumping rate of 2,000 gpm, or possibly slightly greater, could be possible.
- An initial specific capacity in the range of 25 to 35 gpm/ft ddn. This is dependent upon the depths of the perforated intervals, and on the actual nature (e.g., the grain size distribution, aquifer thickness, hydraulic conductivity, etc.) of the aquifer systems encountered at the drill site.
- Elevated concentrations of TDS, Fe, and Mn are likely to present in groundwater pumped from the new well.

Site Logistical Considerations

Based on the site visit, logistical constraints for construction conditions at the site are relatively favorable, as follows:

- The site has the potential to be large, measuring approximately 100 feet by 300 feet (assuming the adjacent empty lot on the west is available for use), and thus the entire property would provide adequate room for a drill rig and all associated equipment and well construction materials (see Figure 1).

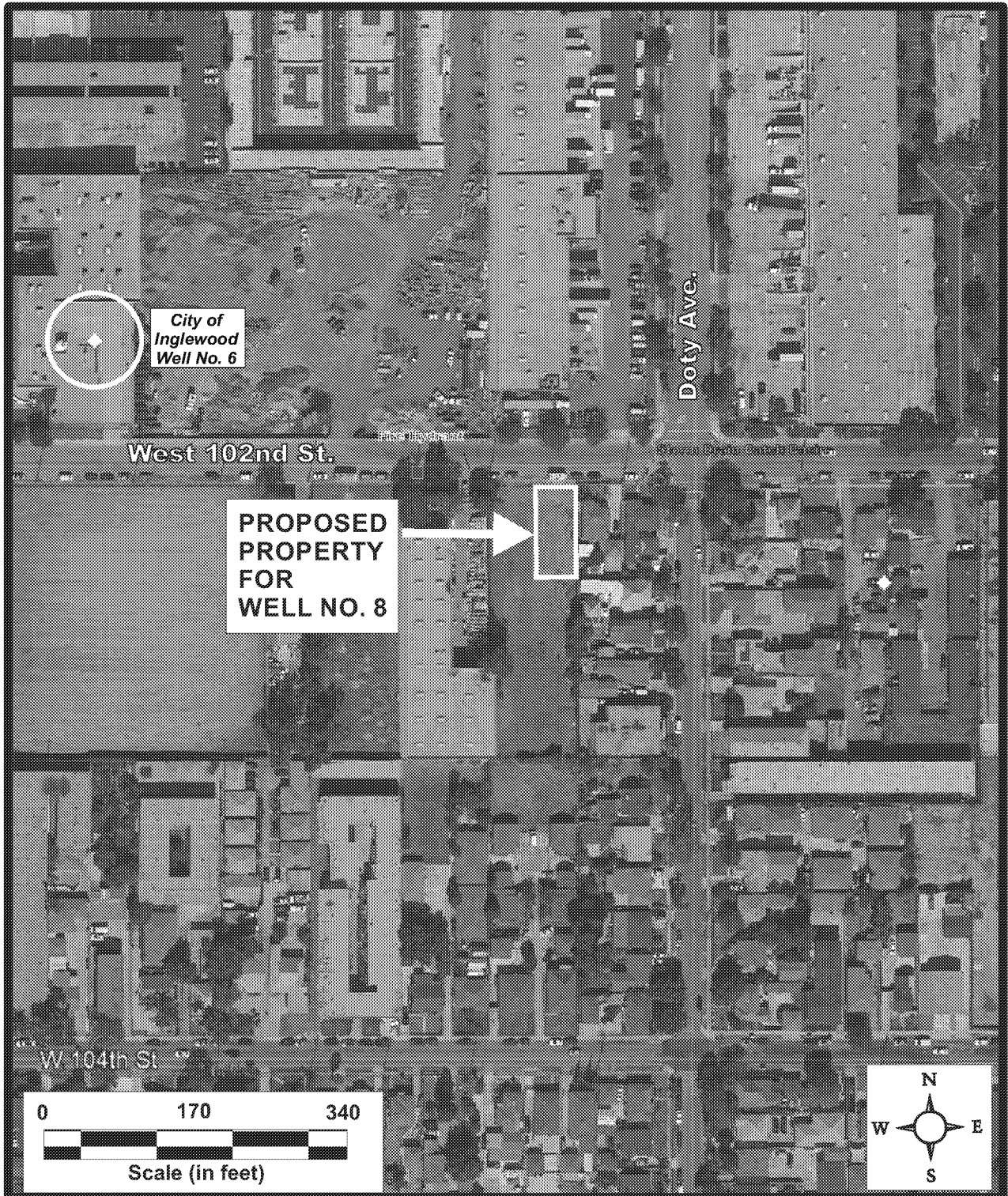

City of
Inglewood
Well No. 6

West 102nd St.

Doty Ave.

PROPOSED
PROPERTY
FOR
WELL NO. 8

W 104th St.

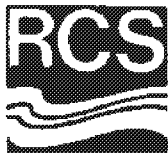
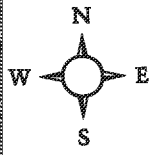
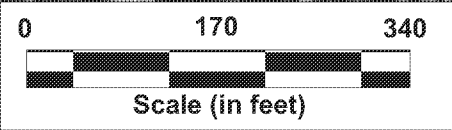

RICHARD C. SLADE & ASSOCIATES LLC
CONSULTING GROUNDWATER GEOLOGISTS
 14051 Burbank Blvd., Suite 300
 Sherman Oaks, CA 91401
 Southern California (818) 506-0418
 Northern California (707) 963-3914
 www.rcslade.com

FIGURE 6
DETAILED SITE MAP

RCS Job No. 106-LAS01-5

March 2018

- The site lies within a residential area, with residences adjacent to the east side of the proposed well site. Noise control measures by means of a full sound wall enclosure will need to be implemented at the site during construction.
- Ingress/egress to the site would principally be through the north side of the site via W 102nd St. There are overhead utilities on the north side of the site, but these appear to have sufficient height such that the wires should not pose a problem for site ingress/egress for a drill rig. However, if the resting mast of the drill rig upon site mobilization and demobilization stands higher than 15 ft above ground surface, then these wires may need to be moved upward, slightly.
- The entire site would need to be provided with security, when drilling crews are not onsite.
- There are no storm drains located on or at the site. However, there is a storm drain located at the northeast corner of the intersection of S Doty Ave and W 102nd St. A discharge line would need to be constructed from the drill site, along the south side of W 201st St, crossing only one driveway at the closest residence (to the east) and a gated walkway to a second residence at the corner of that intersection to the east. As such, a total discharge line length of approximately 170 feet is needed to reach that storm drain. Ramped discharge piping will be needed at the driveways to accommodate vehicular ingress/egress for the occupants for those residences.

An alternate storm drain location for discharge of fluids is present approximately 1,000 ft to the west near the southeast corner of the intersection of Prairie and 102nd St. Along this alignment, the driveways for two businesses exist. Ingress/egress through these driveways can also be accommodated through ramped discharge piping. This may be a preferred alternative to the discharge location discussed above.

- There is a fire hydrant located near the site, approximately 160 ft west of the proposed well site along W 102nd St; this fire hydrant can easily be utilized to provide "make up" water that is required by the drill rig during pilot hole drilling and reaming operations.

The current location of the well site, as shown on Figure 6, is preliminary. This location should be sufficient to allow adequate room for drilling equipment on the east side of the site. However, the vacant property south and west of the site, which is currently owned by the City, will need to be utilized to provide additional room for the temporary storage of other well construction equipment and materials. It is possible that the final location of the site could be shifted, based on the needs of the driller and on regulatory clearance requirements (such as the lateral separation between the drill site, sewer lines, etc).

Permitting Elements

There are a few key permits that will need to be obtained prior to commencement of construction operations at the proposed site for new Well No. 8. Such key permits include:

- A well drilling permit will be necessary to start construction on the well. This permit is obtained by the selected drilling contractor from the Los Angeles County Environmental Health Services (LACEHS) and is needed prior to the construction of the proposed well. Specifically, a permit application is filed by the driller a few weeks in advance of commencement of his drilling operations at the site.
- The SWRCB general construction permit does require the development of a storm water pollution prevention plan (SWPPP) for this drill project, as per the SWRCB Order No. 2009-0009–DWQ, as Amended by 2010-0014–DWQ and 2012-0006–DWQ; Construction General Permit (CGP) No. CAS000002. The SWRCB construction general permit states that a SWPPP is required for:

“any construction or demolition activity, including, but not limited to, clearing, grading, grubbing, or excavation, or any other activity that results in a land disturbance of equal to or greater than one acre and any Construction activity associated with linear underground/overhead projects (LUPs) including, but not limited to, those activities necessary for the installation of underground and overhead linear facilities (e.g., conduits, substructures, pipelines, towers, poles, cables, wires, connectors, switching, regulating and transforming equipment and associated ancillary facilities) and include, but are not limited to, underground utility mark-out, potholing, concrete and asphalt cutting and removal, trenching, excavation, boring and drilling, access road and pole/tower pad and cable/wire pull station, substation construction, substructure installation, construction of tower footings and/or foundations, pole and tower installations, pipeline installations, welding, concrete and/or pavement repair or , and stockpile/borrow locations.”

Because the entire footprint of “disturbed” land at the subject site (including the areas to spread drill cuttings and to temporarily store drill/testing fluids) is estimated to be a maximum of 0.5 acres (or less), a SWPPP will not be needed. It should also be noted that no aboveground or underground additional pipeline work is anticipated in conjunction with this drilling project.

- Because discharge of well development and testing fluids will be performed to the local storm drain system, then the City may need to obtain an encroachment permit from the Los Angeles County Department of Public Works.
- Discharges to the local storm drain system are currently regulated under a de minimus National Pollutant Discharge Elimination System (NPDES) permit promulgated by the Los Angeles Regional Water quality Control Board (RWQCB). Formerly, discharges of groundwater from potable water-supply wells were regulated under Adopted Board Order No. R4-2003-0108. However, in 2014 the SWRCB adopted a state-wide permit for discharges from public water systems under Order No. WQ 2014-0194-DWQ. Page 6, Item 1b of that order states that authorized discharges include planned discharges due to “Groundwater well development, rehabilitation and testing.” As a result, the Los Angeles RWQCB is in the process of terminating the permit process for R4-2003-0108 de minimus NPDES permit.

- The contractor will be required to ensure that the current industry-standardized best-management practices (BMPs) be implemented at the subject drill site to properly minimize the impacts on the San Gabriel River or associated tributaries, by reducing the volume of and improving the quality of surface water runoff from the subject drill site that would normally drain into the San Gabriel River and/or its tributaries. At a minimum, the contractor will be responsible for the installation of a rumble rack BMP at the entrance to the drill site, and the installation of sandbags and straw wattle around the perimeter of any temporarily-stockpiled drill cuttings.
- Other required permits are not associated with the actual construction of the well. For example, a permit to operate the well will need to be obtained from the DDW during the equipping phase of the new well. No other permits are required from any other local agency.

Clearances

Generally, potable water-supply wells must maintain adequate clearances from utilities and other structures, such as sewer laterals, sewer manholes and storm drains, as defined by existing DWR water well standards. Thus, the final well site will need to be appropriately selected to maintain proper setback from any sewer laterals that may be present on adjacent properties. A setback of at least 50 ft is necessary.

It should also be noted that the site was formerly occupied by a residence, which was previously demolished, although the date of that demolition is unknown. Further, it is not known whether all sewer laterals for that former residence were removed. Thus, prior to constructing a well at the site, a determination should be made by the City as to whether or not any sewer laterals still remain at the site.



POTENTIALLY CONTAMINATING ACTIVITIES

Inventory of Potentially Contaminating Activities

A preliminary inventory of past and current potentially contaminating activities (PCAs) was compiled for the proposed well site. This initial survey, which was performed using the California Regional Water Quality Control Board (RWQCB) GeoTracker website, provides a compilation of: leaking underground storage tank (LUST) sites; Department of Toxic Substances Control (DTSC) cleanup sites, land disposal sites, waste permit sites, permitted underground storage tank (UST) sites; and the locations of possible groundwater monitoring wells. The majority of these nearby PCAs appear to consist of predominantly LUST sites.

Figure 7, "GeoTracker Map of Proposed Well Site and Vicinity", shows the location of PCAs in the vicinity of the proposed well site. The symbols on the map indicate the following types of PCAs:

- The light blue triangles, of which there are seven, indicate sites where the DTSC is the lead agency for regulating site activities. All these sites are schools which were investigated by the DTSC and determined by that agency that no action was required.
- The dark open squares, of which there are eight, indicate only those sites which have registered UST sites.
- The several dark red squares with an X through them delineate those LUST sites where the RWQCB is the lead agency. These symbols show those sites where cleanup actions have been completed and the case has been closed by that agency.
- The open dark red squares indicate those LUST sites where current cleanup/remediation is occurring but are currently eligible for closure. Some of these sites are associated with groundwater monitoring wells/sampling points which are specifically denoted by the pink circle symbols.
- The open green squares are those LUST sites where current cleanup/remediation is occurring and the sites are still open. These sites are usually associated with groundwater monitoring wells/sampling points (also denoted by the pink circle symbols).

For the proposed new well site, the main PCA of concern would likely be that denoted by the "Hollywood Park Development Area," which lies north of the proposed drill site, as seen on Figure 7. This is the site of the former Hollywood Park Racetrack, which has been closed and is currently undergoing development as a football stadium and entertainment center. According to the GeoTracker website, this area was used for agriculture until 1938, when the racetrack

was built. The racetrack contained several dry cleaners and vehicle maintenance yards, from which soil contamination containing tetrachloroethene (PCE), nitrate (NO₃) as nitrogen (N), total petroleum hydrocarbons (TPH), and perchlorate were reported in 2006. Based on a groundwater investigation via four monitoring wells containing perforations ranging from 85 ft bgs to 139 ft bgs, it was found that the only MCL exceedances in the groundwater occurred with respect to NO₃ as N (11 to 16 mg/L) and that these exceedances were encountered at/near the southwest end of the former racetrack. The monitoring took place within four quarters from 2008 to 2009, as ordered by the Los Angeles office of the RWQCB. It was also reported that the detected contamination was likely due to other known groundwater issues associated with historical agriculture in the region. In a March 2010 letter to Hollywood Park, the RWQCB concluded that the local groundwater monitoring wells no longer needed to be sampled and could be scheduled for destruction. The contaminants in those monitoring wells appear to be contained within the shallow aquifer system; this system will not be perforated by the proposed new City well.

Since 2010, extensive soil sampling and remediation efforts have been undertaken at the former racetrack and numerous documents by various consultants have been generated. In addition, numerous soil borings have been drilled at the site to define the extent of arsenic contamination. All these soil borings are shallow, having been drilled no deeper than 10 ft bgs. Remediation of contaminated soils at the former race track consisted of excavating the impacted soils. In a letter dated July 25, 2017, RWQCB Staff concluded “that arsenic-impacted soil in the Western Parking Lot Area has been adequately removed and remediated and the area within the boundaries of the Western Parking Lot Area is determined to be acceptable for unrestricted residential land use.”

In August 2017, a Soil Management Plan (SMP) Implementation Summary for the North Lake Area at the former racetrack was submitted by EKI Environment & Water. This SMP was submitted to the RWQCB regarding the “excavation and off-site disposal of soil identified near the north shore of the North Lake Area with concentrations of total petroleum hydrocarbons in the gasoline-, diesel-, and motor oil-ranges above the Property-specific criteria.” That 2017-dated document is the most recent online report available for the former racetrack, and it appears that the soil remediation as described above was completed.

CONCLUSIONS

Well Site Feasibility

Based on our hydrogeologic evaluation, the Silverado aquifer at the proposed site for Well No. 8 may occur at depths between 420 ft and 620 ft bgs whereas the underlying Sunnyside aquifer could occur from 630 to 700 ft bgs. However, it is possible that some of the overlying (shallower) aquifer systems could also be perforated by the new well, and the suitability of each of these aquifer systems will need to be further assessed during drilling and testing in the open pilot hole for the new well.

Consequently, it is hydrogeologically feasible that a new municipal-supply water well can be constructed at the proposed well site to replace existing Well No. 6. However, it should be noted that water quality issues regarding elevated TDS, Fe, and Mn concentrations could be present in a final wellblend sample from the well. Because groundwater at the proposed well site may have elevated concentrations of Fe and/or Mn and, potentially, TDS, isolated aquifer zone testing will be particularly useful as an aid to check for the presence of these constituents near the borehole and under the low-flow and short-term nature of such zone testing. Furthermore, zone testing will include analysis for other parameters including VOCs and perchlorate, which have been documented to occur in prior, shallow, monitoring wells at the former Hollywood Park Racetrack. Nonetheless, it is likely that the water quality of a sample from the proposed new well will likely be similar to existing Well No. 6, if new Well No. 8 is constructed with perforation intervals set at similar depths.

PRELIMINARY WELL DESIGN CRITERIA

Proposed Well No. 8 will be a replacement for existing Well No. 6. As such, the new well is to be constructed similar to Well No. 6. However, review of the electric log for existing Well No. 6 shows that additional aquifer systems could have been utilized below the known cased depth of that well. Figure 8, "Preliminary Well Design Diagram, Proposed Well No. 8" illustrates the preliminary design for the proposed new well.

For the construction of Well No. 8, it is highly recommended that a set of Technical Specifications and Bid Sheets be prepared and submitted to qualified drilling firms in a competitive bidding process, rather than through a design-build process. These Technical Specifications will specify methods, procedures, standards, and the preliminary materials to be used for the activities associated with well drilling, construction, and testing of the new well.

The final well construction materials and design will be determined only after pilot borehole drilling data are acquired and will be based on the results of the geologic logging of the drill cuttings, grain size analysis of drill cuttings, downhole geophysical surveying (electric logs), and results of isolated aquifer zone testing in the open pilot borehole. A short description for the preliminary well design is provided in the following sections.

Pilot Borehole Drilling and Reaming

- The reverse circulation drilling method is recommended. Drill cuttings generated during drilling will need to be removed from the proposed well site. The drilling contractor will need to obtain a drilling permit from LACDEHS, prior to mobilizing this drill rig to the site.
- There are residences in the area and, thus, sound control measures will need to be implemented during construction, especially if drilling is conducted on a 24-hour per day schedule. Further, site security measures will need to be provided by the Contractor.
- A conductor casing should be installed by drilling a borehole to a minimum depth of 50 ft bgs and to a minimum diameter of 48 inches. Install approximately 50 ft of 42-inch outside diameter (O.D.) by 3/8-inch (minimum) wall thickness low carbon steel (LCS), i.e., mild steel, conductor casing. Grout the annular space between this casing and the wall of the borehole from the bottom of the conductor to ground surface. The grouting of the annular space between the conductor borehole and conductor casing can constitute the cement sanitary seal for the new well.
- Drill a 12- to 18-inch diameter pilot hole to a depth of approximately 750 ft bgs. An Eastman Drift survey should be conducted at 100-foot depth intervals to help maintain a relatively straight and vertical borehole during drilling and during subsequent reaming of the borehole.

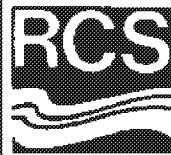
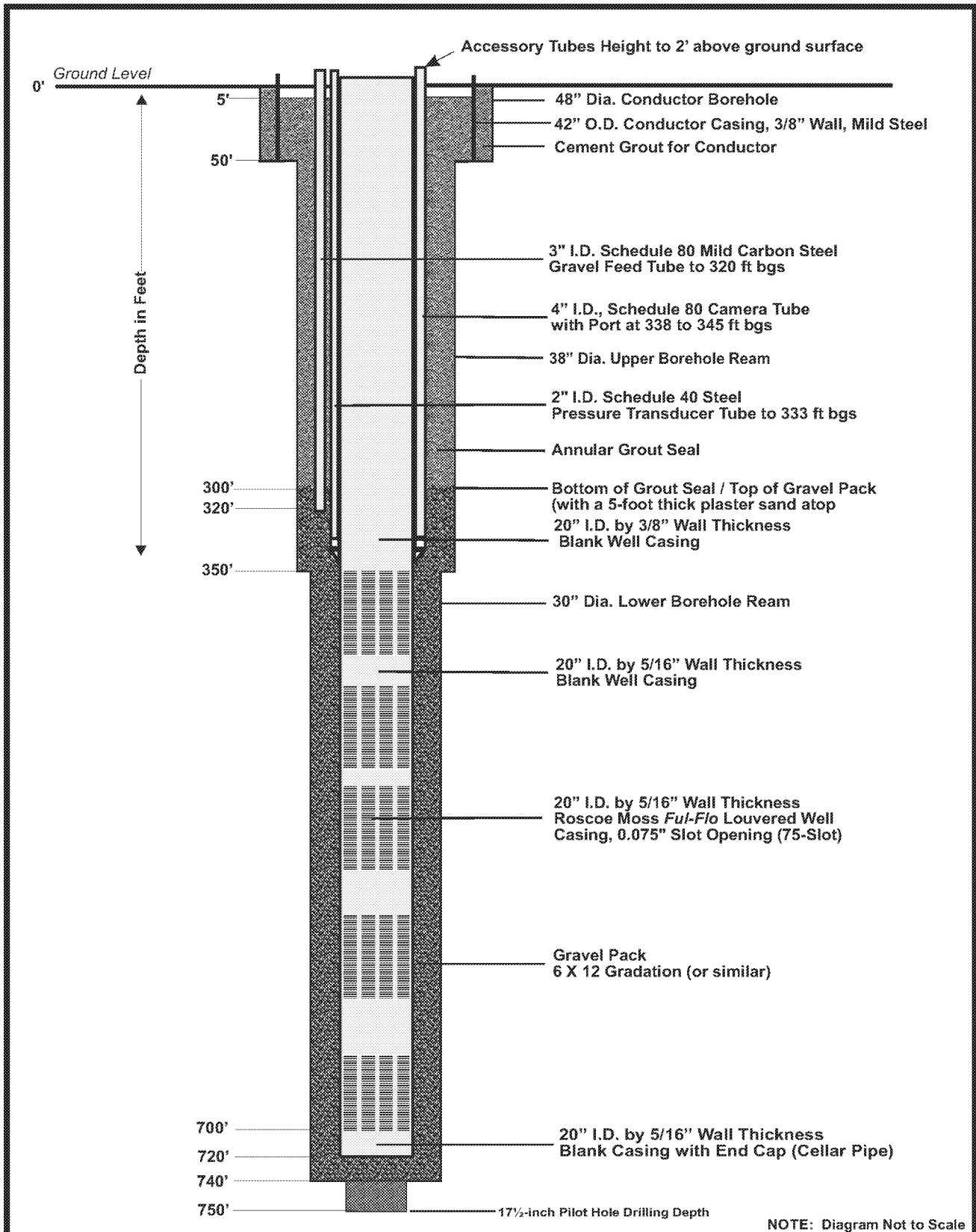

RICHARD C. SLADE & ASSOCIATES LLC
CONSULTING GROUNDWATER GEOLOGISTS
 14051 Burbank Blvd., Suite 300
 Sherman Oaks, CA 91401
 Southern California (818) 506-0418
 Northern California (707) 963-3914
 www.rcslade.com

FIGURE 8
PRELIMINARY WELL DESIGN DIAGRAM
PROPOSED WELL NO. 8

Job No. 106-LAS10-5

March 2018

- Collect and log the drill cuttings and submit representative drill samples for grain size analysis; from the results of this testing, the filter pack and perforation slot sizes will be determined.
- Conduct downhole geophysical surveying (i.e., electric logging) with a spontaneous potential (SP) survey, short-normal (16-inch) and long-normal (64-inch) resistivity surveys, a laterolog 3 or a focused resistivity (guard) survey, a sonic variable density survey, a gamma-ray survey, and a magnetic deviation survey of the pilot hole.
- Conduct isolated aquifer zone testing in approximately four (4) depth zones that are to be selected by RCS geologists after reviewing the new electric logs. This testing will be performed to check groundwater quality conditions for concentrations of selected constituents, including a general minerals and inorganic suite, VOCs, and other constituents such as perchlorate. This zone testing generally will be done under the low-flow and short-term pumping conditions that are permitted by the current zone testing methodology in open boreholes.
- Following receipt of the laboratory analyses from isolated aquifer zone testing and after review of the results, a final well design is to be prepared. The upper portion of the pilot hole can be reamed to 38 inches in diameter and to a depth of 350 ft bgs; following this ream, then the lower portion of the borehole below 350 ft bgs can be reamed to a diameter of 30 inches and to a maximum depth of 740 ft bgs (see Figure 8).
- Following completion of reaming activities, perform a caliper survey and a second magnetic deviation survey of the borehole reams.

Well Casing and Gravel Pack

- The recommended type of casing for the well is to consist of Type 304L Stainless Steel. The use of this type of casing will provide protection against corrosion and can serve to also slow down the problems typically associated with the growth of biofilm in well casings.
- Install 20-inch inside diameter (I.D.) by 3/8-inch wall thickness steel blank well casing from ground surface to a maximum depth of 350 ft bgs. This well casing will also extend two feet above ground surface (see Figure 8).
- From 350 ft to 700 ft bgs, install 300 feet (maximum) of 20-inch I.D. by 5/16-inch wall thickness Roscoe Moss Ful-flo type louvered well casing, interspersed with approximately 50 feet of blank casing. The placement of the blank casing will depend on the local depth and thicknesses of clay layers. A slot size of 0.075 inches is preliminarily recommended at this time for the louver openings. However, this slot size opening could change based on gradation analyses of in-situ formation samples.
- At the bottom of the casing, install a 20-foot section of 20-inch I.D. by 5/16-inch wall thickness cellar pipe with an end cap; hence, the bottom of the well casing will be set to a maximum depth of 720 ft bgs.
- Provide a 4-inch I.D camera tube; a 3-inch I.D. gravel feed tube, a 3-inch I.D. vent tube and a 2-inch I.D. sounding tube. The camera tube and sounding tube shall enter the blank well casing at depths above 350 ft bgs (as shown on Figure 8),

whereas the vent tubes will each be placed to a depth of 2 ft bgs. The tops of these tubes are also to extend 2 feet above ground surface.

- A 6 X 12 gradation to the gravel pack is anticipated at this time, unless gradation analysis of the samples indicates otherwise. This gravel pack can extend from a depth of approximately 300 ft to a depth of 740 ft bgs (440 feet in length). A finer-grained sand pack, 5 feet in length, will be installed on top of the gravel pack to prevent cement filtrate from entering the top of the underlying gravel pack.
- The use of "Silibeads" gravel pack is preliminarily recommended at this time. This type of gravel pack is manufactured, has a sphericity approaching one and also has a very high silica content (65% to 75% silicon dioxide). As such, the use of this type of manufactured gravel pack can greatly improve the flow of water into the well and, thus, increase the efficiency of the well. Further, it will also serve to retard the growth of biofilm in the well, whereas the more conventional (mined) gravels cannot. However, the final choice of gravel will need to be determined during the final design phase of the project, prior to obtaining a contractor to conduct drilling and construction operations at the site.
- A deep cement seal, from 5 ft bgs to 300 ft bgs (250 ft in total length), is recommended, to help prevent the downward migration of contaminants from the upper, shallow aquifer systems at the drill site. The final depth of this seal to be determined by the results of isolated aquifer zone testing and by analysis of the electric logs of the pilot hole for the new well.

Well Development

- The well will be initially developed by mechanical methods, by simultaneously airlifting and swabbing in each 20-foot section of louvered well casing. The use of development chemicals (chlorination and/or dispersants) will also be required. Mechanical and chemical development should be conducted for a maximum period of 120 hours in the new well or until no further significant removal of sand or drilling fluids and cuttings are observed. A video survey should be performed at the end of mechanical development to determine the effectiveness of this development. The use of manufactured "Silibeads" gravel pack may serve to also speed up the mechanical, chemical, and pumping development of the new well.
- A temporary test pump will be installed in the new well and well development continued by pumping methods. The test pump is to have a pumping capacity of up to 4,500 gpm and the pump intake can be set to a maximum depth of approximately 325 ft. A period of 40 hours (minimum) of pumping development is estimated to be conducted in the well.

Downwell Testing

- Pumping tests shall be performed on the new well and will consist of a 12-hour, 4-step drawdown test, followed by a 24- to 48-hour (maximum) constant rate pumping test to help identify well production capacities and preliminary aquifer parameters. The pre-design target production rate is to be 1,500 and 2,500 gpm, or greater if possible.
- Near the end of the constant rate pumping test, conduct a dynamic spinner survey in the well, to obtain baseline data for the well under pumping conditions. These data

can be compared to future spinner data in the well and can help to determine the differential change in each section of perforations.

- Following the dynamic spinner survey, conduct depth-specific sampling in the perforated section of the well under pumping conditions.
- A gyroscopic alignment and plumbness survey, a static spinner survey and a final video survey will be performed within the casing following removal of the test pump.
- A final well disinfection (via chlorination) will be conducted in the well.

Preliminary Opinion of Probable Well Construction Costs

The preliminary Contractor cost for drilling, constructing, and testing of the proposed new water well is estimated to be approximately \$1,000,000 and \$1,300,000, in accordance with the above preliminary design parameters. This does not include any costs for: purchasing any property; equipping the new well with a pump, pump column, and motor; and/or any above-ground piping and/or structures at the selected well site.

DESTRUCTION OF EXISTING WELL

Existing City Well No. 6, located approximately 550 ft northwest of the proposed well site is scheduled to be destroyed, prior to the property re-development of this property. However, it should be noted that this well should not be destroyed until after proposed new City Well No. 8 is fully constructed and tested. Table 1 shows that this well was cased to a total depth of 670 ft. Well No. 6 is the City's newest well, having been constructed in 2003 (see Table 1). Thus, the well has been in continuous service for approximately 14 years. However, there are only very limited available data for water levels, pumping rates or specific capacities and these limited data date from the well collected during post-construction pumping tests and rehabilitation operations between 2007 and 2014.

Previous Work on the Existing Well

On November 19, 2007, the Layne Christensen Company (Layne) performed a video survey in Well No. 6. In the video survey report (no video log was available) a SWL was documented at 119.2 ft below top of casing (btc) and Layne noted the presence of two patches, at depths of 272 ft to 276 ft btc and at 312 ft to 316 ft btc (there is no available information as to who installed them or when these two patches were installed in the well). In the lower patch, groundwater was reported to be "jetting" out from the top of the patch. In addition, at depths of 434 ft and 454 ft btc, the presence of holes at the casing joints was reported on the video survey. However, there are no data or information available to indicate what, if anything, was done to the well to remediate these problems at that time.

In 2011, the well underwent rehabilitation by Bakersfield Well & Pump Company (BWP). Indeed, a video survey performed by Longmire, on August 25, 2011, showed a SWL depth of 127 ft btc and revealed the presence of several holes that could be observed (via water jetting out into the casing) at various depths in the casing, and at the locations of the two upper patches in the well, and also at additional casing joints. Consequently, BWP subcontracted with Longmire to perform the emplacement of additional patches on the interior walls of the casing. Based on the video log, it appears that additional patches were placed in the well at the following depths: 270 ft to 274 ft btc, 311 ft to 315 ft btc, 431 ft to 435 ft btc, and 452 ft to 456 ft btc. A subsequent video performed on the well on October 10, 2011 revealed that the new patches appear to have been set successfully, with the exception of the patch at 431 ft to 435 ft

btc. At this depth, it could be observed that water was still flowing into the casing through the top and, possibly, through the bottom of this particular patch.

On February 15, 2013, Layne performed another video survey of the well, which revealed a SWL of 115.8 ft btc. In that video survey, Layne noted the appearance of additional holes in the casing at depths of 272.5 ft btc (within a previously placed patch), at 286.2 ft btc (although this latter reported hole appears likely to be a scrape in the biofilm of the casing, upon RCS review of the video) and at 312.6 ft btc. Further, Layne reported that water was flowing through the top and bottom of the two lowest patches previously installed in 2011, at depths of 431 to 435 ft and 452 to 456 ft btc (RCS confirmed these depths upon review of the video log). There was no information nor was it reported by City Staff as to whether or not these holes have been rectified. It should be noted that the development of holes and additional leakage of the emplaced patches in the future appears highly likely, based on the evidence in the 2011 and 2013 video logs.

Recommended Destruction Procedures on the Well

Destruction of this existing well will be necessary prior to conducting the proposed redevelopment of the property on which this well exists. A well drilling contractor with experience in well destruction should be utilized for the destruction process on the well. Prior to destruction, the selected contractor will need to file a well destruction permit with LACDEHS. It is currently envisioned that destruction of this existing well can be accomplished in the following steps:

1. Remove the existing motor, pump column and pump and all other above-ground piping from the well.
2. Perform an initial video survey of the well after pump removal to determine the current condition of the casing.
3. Bail sediment fill from the bottom of the casing.
4. Two methods for performing well destruction are currently available: placing additional perforations downwell, using a Mills Knife tool (or a star perforator) or using the "shot" perforation method. Because the well has current issues with regard to casing integrity, as noted above, placing new perforations in the well could be problematic and there is the potential for a perforating tool to become lodged inside the casing. It is possible that only the upper 150 ft of blank casing can be perforated, but the lower portion of the casing below 150 ft bgs also needs to be destroyed.

Thus, it is recommended that the shot perforation method be used instead. This will consist of placing the "shot" charges along the entire length of the casing. Following placement of the string of charges, the casing can be filled with cement, via a tremie

pipe, up to a depth of 10 ft bgs. Once the cement has been placed, the “shot” charges can be detonated. It should be noted that the nearest residences to the site are approximately 250 ft to the northeast. Thus, any shockwaves generated by detonation of the “shot” charges will likely undergo significant attenuation and, thus, they are not likely to impact those residents.

5. Following detonation of the “shot” charges, top off the cement inside the casing up to a depth of 10 ft bgs.
6. Let the cement set of a minimum period of 48 hours and then excavate down around the casing to a depth of approximately 7 ft and cut off the upper 6 ft of the exposed well casing, in preparation for installation of the final “mushroom cap”. Rebar should also be installed across the opening of the wellhead following removal of the upper 6 ft of well casing.
7. Prior to placing the mushroom cap, place rebar atop the well opening. Following this, the cement for the mushroom cap can be poured until it reaches a depth of 4 to 5 ft bgs inside the excavation.
8. Properly backfill and compact the remaining excavation with native soil. Compaction should be conducted in accordance with City and/or County building/grading codes.
9. The Contractor should then file the appropriate well destruction form(s) with LACDEH and State DWR.

Preliminary Opinion of Probable Well Destruction Costs

The preliminary Contractor cost for destruction of the existing well is estimated to range from approximately \$60,000 and \$90,000, in accordance with the above recommended well destruction parameters.

PRELIMINARY ASSESSMENT OF PUMPING RATES

Table 5, “Preliminary Assessment of Pump Rate and Depth Setting”, presents a preliminary evaluation of the depth setting and final pumping rate for the new permanent pump in proposed City Well No. 8. Table 5 represents anticipated potential pumping rates and resulting pumping water levels that may occur in the new well, based on the available data from other existing, nearby water wells.

It is anticipated that, under current conditions, estimated pumping rates in the range of 1,500 to 2,500 gpm could be realized from the new well, as shown on Table 5. Thus, with a current SWL of approximately 130 ft bgs in nearby Well No. 6, as reported by the City in February 2018 (email communication, Thomas Lee, 2/27/2018), a pumping water level could occur at a depth of 168 to 213 ft bgs at this time, depending on the final pumping rate of the new well. Factoring in an anticipated 15% decrease in the specific capacity value of the well over time and an additional 50-foot water level decline (due to long-term drought conditions in the region), future pumping levels at depths on the order of 224 to 278 ft bgs might occur. Thus, the intake for the permanent pump could be placed at a minimum depth ranging from 250 ft to 300 ft bgs, depending on the final pumping rate achieved and the final specific capacity obtained after the well is constructed and tested.

Table 5 only provides an estimate of anticipated pumping parameters for the proposed new well, based on assumptions drawn from the available data. The recommended pump depth setting does not take into consideration system backpressures and frictional losses that could result in yet deeper pumping levels and a deeper pump depth setting. The final pump depth setting will need to be based on actual SWLs, pumping rates, PWLs and specific capacities determined during actual test pumping of the well and, additionally, on the calculation of backpressures and frictional losses as determined by a water systems/pump engineer.

**TABLE 5
PRELIMINARY ASSESSMENT OF PUMPING RATES AND PUMP DEPTH SETTINGS
PROPOSED CITY OF INGLEWOOD WELL NO. 8**

Item	Parameter	Potential Values		
A.	Reported Static Water Level Depth at Well No. 6, February 2018 (ft bgs).	130		
B.	Estimated Current Specific Capacity of New Well (gpm/ft ddn).	40	35	30
C.	Possible Maximum Pumping Rate (gpm).	1,500	2,000	2,500
D.	Resulting Drawdown (in ft)=(C/B).	38	57	83
E.	Initial Pumping Water Level Depth (ft bgs)=(A+D).	168	187	213
F.	Additional Water Level Decline (in ft) Due to Estimated 15% Decline in Current Specific Capacity of Well.	7	10	15
G.	Estimated Water Level Decline (in ft) Due to Long-Term Drought.	50	50	50
H.	Estimated Future Pumping Water Level Depth (in ft bgs) with Declines Due to Above Listed Factors=(E+F+G).	224	247	278
I.	Recommended Maximum Depth (ft bgs) for Pump Intake.	250	275	300

- NOTES:**
- 1) bgs = below ground surface.
 - 2) Water levels and calculated data above have been rounded to nearest whole number.
 - 3) The above-estimated pumping parameters do not take into consideration system backpressures and frictional losses that will also affect pumping rates and pumping water levels and, thus, specific capacities. The services of a water system/pump engineer will be needed to calculate these system-specific parameters.

CLOSURE

Disclaimer

This Preliminary Design Report has been prepared for Tetra Tech Inc. and for Wilson Meany Inc. for proposed new City of Inglewood Well No. 8 and applies only to evaluating the hydrogeologic conditions at the proposed well site and to providing the preliminary design of a new, municipal-supply water well at that proposed well site. This Well Site Feasibility and Preliminary Design Well report has been prepared in accordance with the care and skill generally exercised by reputable professionals, under similar circumstances and in this or similar localities. No other warranty, either expressed or implied, is made to the professional advice presented herein.

REFERENCES CITED

- California Department of Water Resources (DWR), June 1961, Bulletin 104, *Planned Utilization of the Groundwater Basins of the Coastal Plain of Los Angeles County, Appendix A, Groundwater Geology*. 181 pp.
- Durfor, C.M., and Becker, E., 1962, *Public Water Supplies of the 100 Largest Cities in the United States*, 1962. U.S. Geological Survey Water-Supply Paper 1812. 364 pp.
- GeoTrans, Inc., April 10, 2010, *Inglewood Well #6 Well Profiling Report, 3901 West 102nd St., Inglewood, California*. 9 pp. Report prepared for the Water Replenishment District of Southern California.

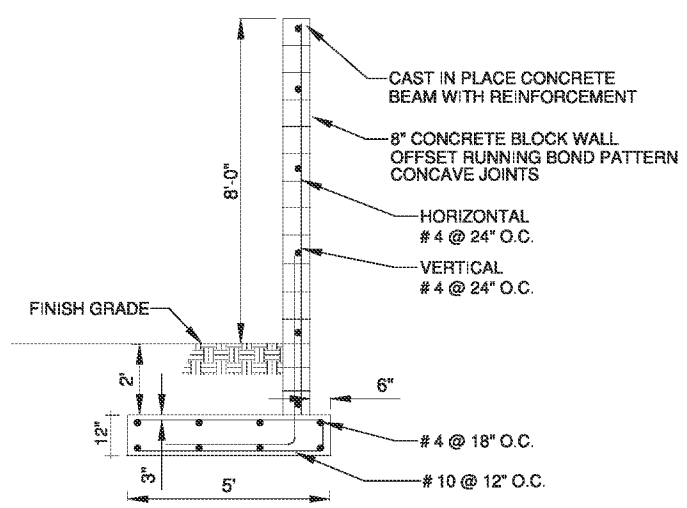
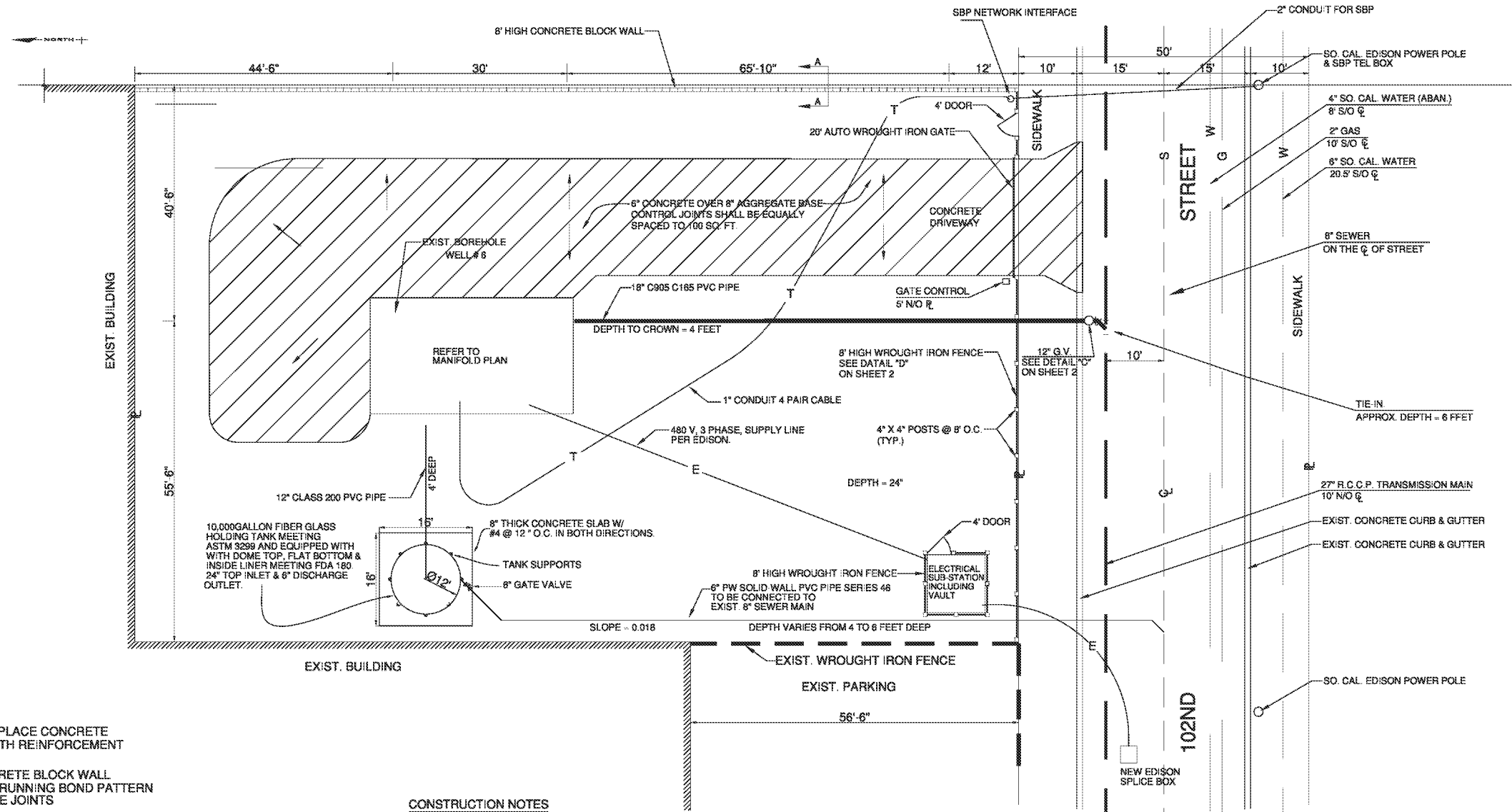

SECTION A-A
1" = 2'-0"

CONSTRUCTION NOTES

- 01. GATE CONTROL
THE AUTOMATIC GATE CONTROL SYSTEM SHALL BE AS MANUFACTURED BY RAMSET MODEL MODEL RAM 5200 (1 HP/220 VAC/4.8 AMPS) TEL. (800) 217-2334, OR APPROVED EQUAL.
- OPERATION: SCADA / LOOPWIRE / CLICKER

PLAN
1" = 10'-0"

GENERAL PLAN

REVISIONS			CITY OF INGLEWOOD, CALIFORNIA PUBLIC WORKS DEPARTMENT	
MARK	DATE	DESCRIPTION	PROJECT TITLE:	PROFILE SCALE:
			WELL # 6 102ND STREET	NONE VERTICAL NONE HORIZONTAL NONE
DESIGNED BY: RY/EE		SUBMITTED BY:		PLAN NO.:
DRAWN BY: R. YESHAYAN		ERIC ESCOBAR, ASSOCIATE ENGINEER		WS-741
CHECKED BY: E. ESCOBAR		ANDY REZA, GENERAL MANAGER		SHEET NO. 1 OF 3